

ROFI transitional tent

model Freedom





Jahn Aamodt design
INDUSTRIAL DESIGNER MID
INTERIOR ARCHITECT NIL

ROFI transitional tent
model Freedom

rofi
www.rofi.com

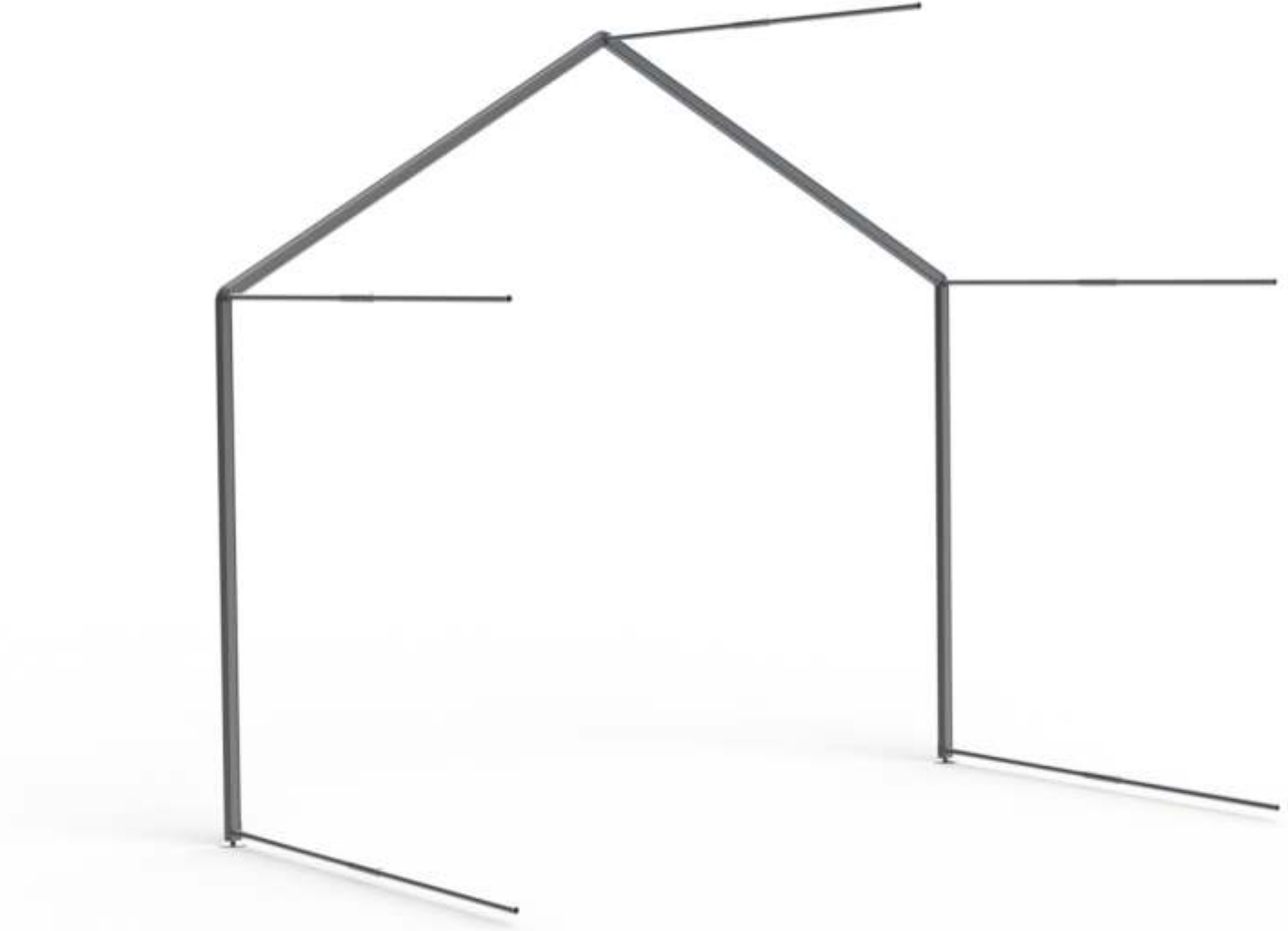

Jahn Aamodt design
INDUSTRIAL DESIGNER MID
INTERIOR ARCHITECT NIL

ROFI transitional tent
model Freedom



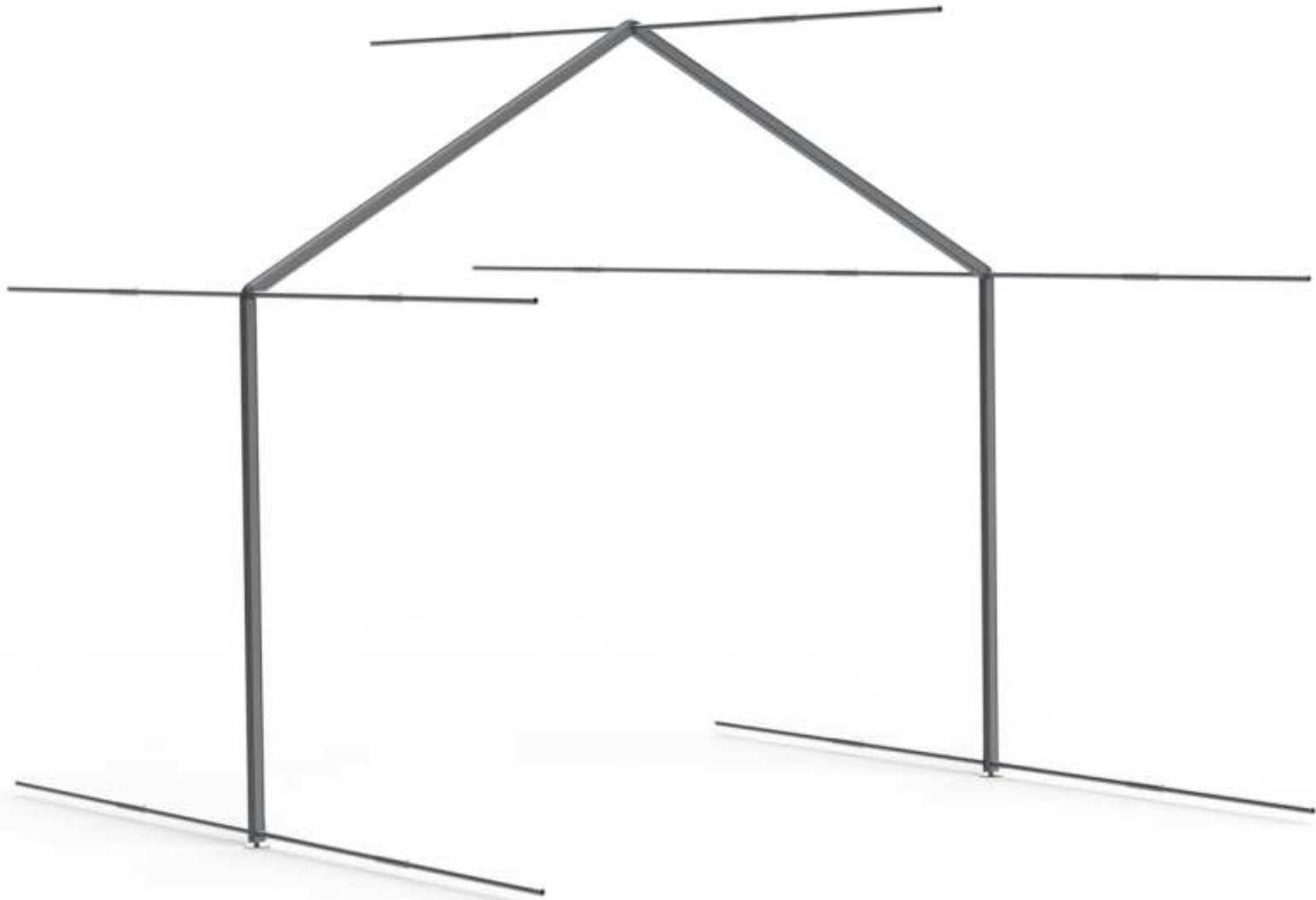

Jahn Aamodt design
INDUSTRIAL DESIGNER MID
INTERIOR ARCHITECT NIL

ROFI transitional tent
model Freedom



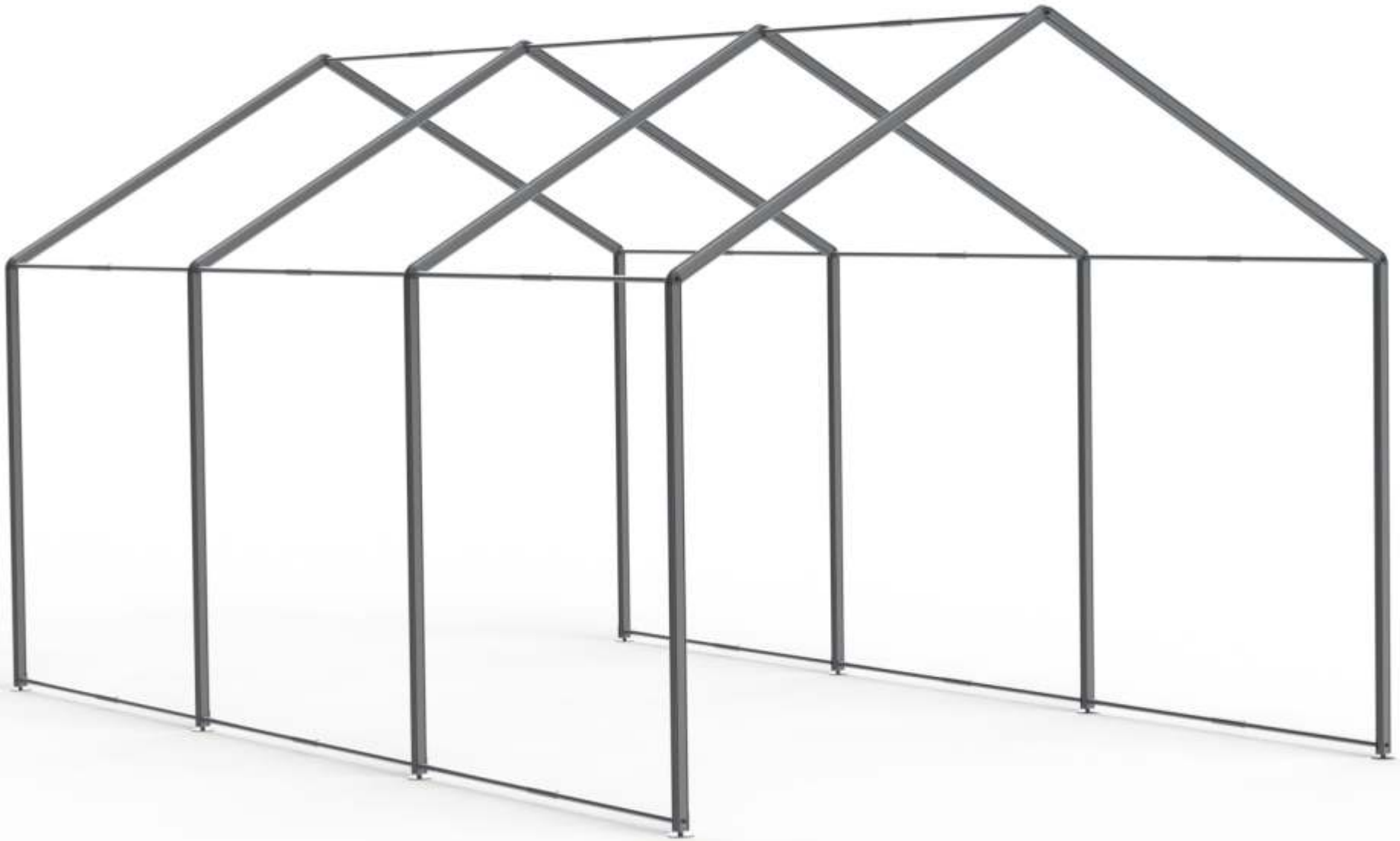

Jahn Aamodt design
INDUSTRIAL DESIGNER MID
INTERIOR ARCHITECT NIL

ROFI transitional tent
model Freedom





Jahn Aamodt design
INDUSTRIAL DESIGNER MID
INTERIOR ARCHITECT NIL

ROFI transitional tent
model Freedom



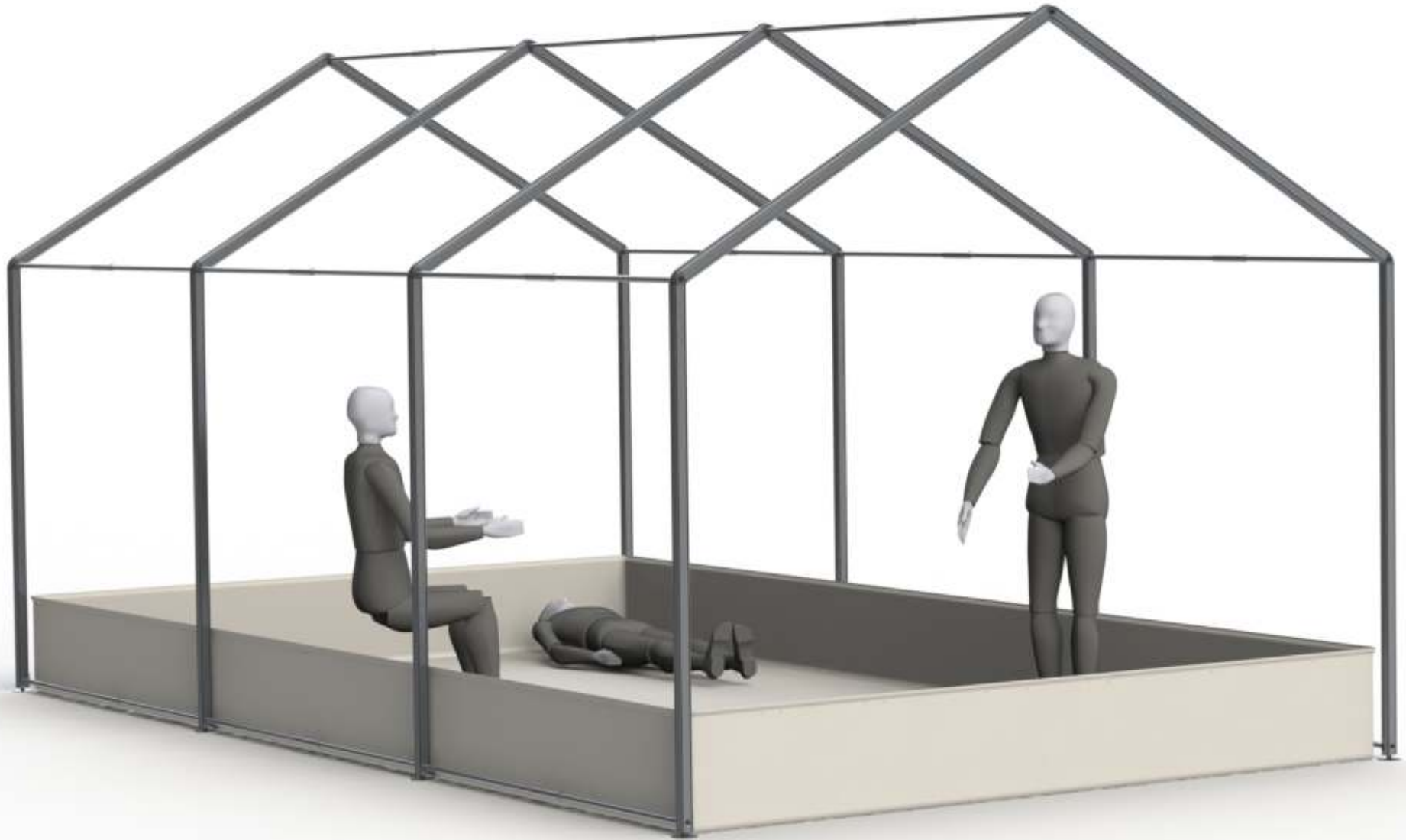

Jahn Aamodt design
INDUSTRIAL DESIGNER MID
INTERIOR ARCHITECT NIL

ROFI transitional tent
model Freedom





Jahn Aamodt design
INDUSTRIAL DESIGNER MID
INTERIOR ARCHITECT NIL

ROFI transitional tent
model Freedom





Jahn Aamodt design
INDUSTRIAL DESIGNER MID
INTERIOR ARCHITECT NIL

ROFI transitional tent
model Freedom



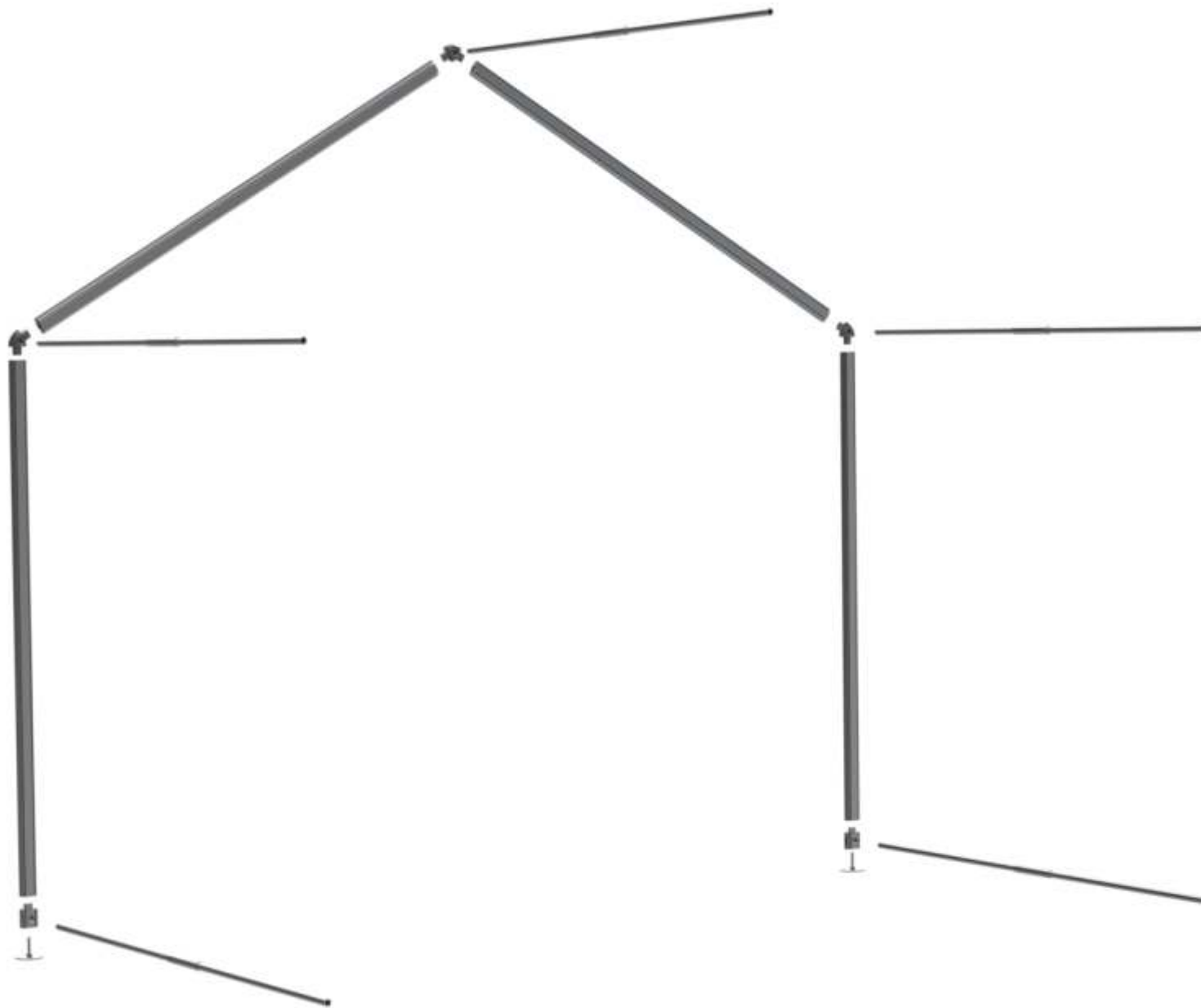

Jahn Aamodt design
INDUSTRIAL DESIGNER MID
INTERIOR ARCHITECT NIL

ROFI transitional tent
model Freedom





Jahn Aamodt design
INDUSTRIAL DESIGNER MID
INTERIOR ARCHITECT NIL

ROFI transitional tent
model Freedom







Jahn Aamodt design
INDUSTRIAL DESIGNER MID
INTERIOR ARCHITECT NIL

ROFI transitional tent
model Freedom





Jahn Aamodt design
INDUSTRIAL DESIGNER MID
INTERIOR ARCHITECT NIL

ROFI transitional tent
model Freedom





Jahn Aamodt design
INDUSTRIAL DESIGNER MID
INTERIOR ARCHITECT NIL

ROFI transitional tent
model Freedom



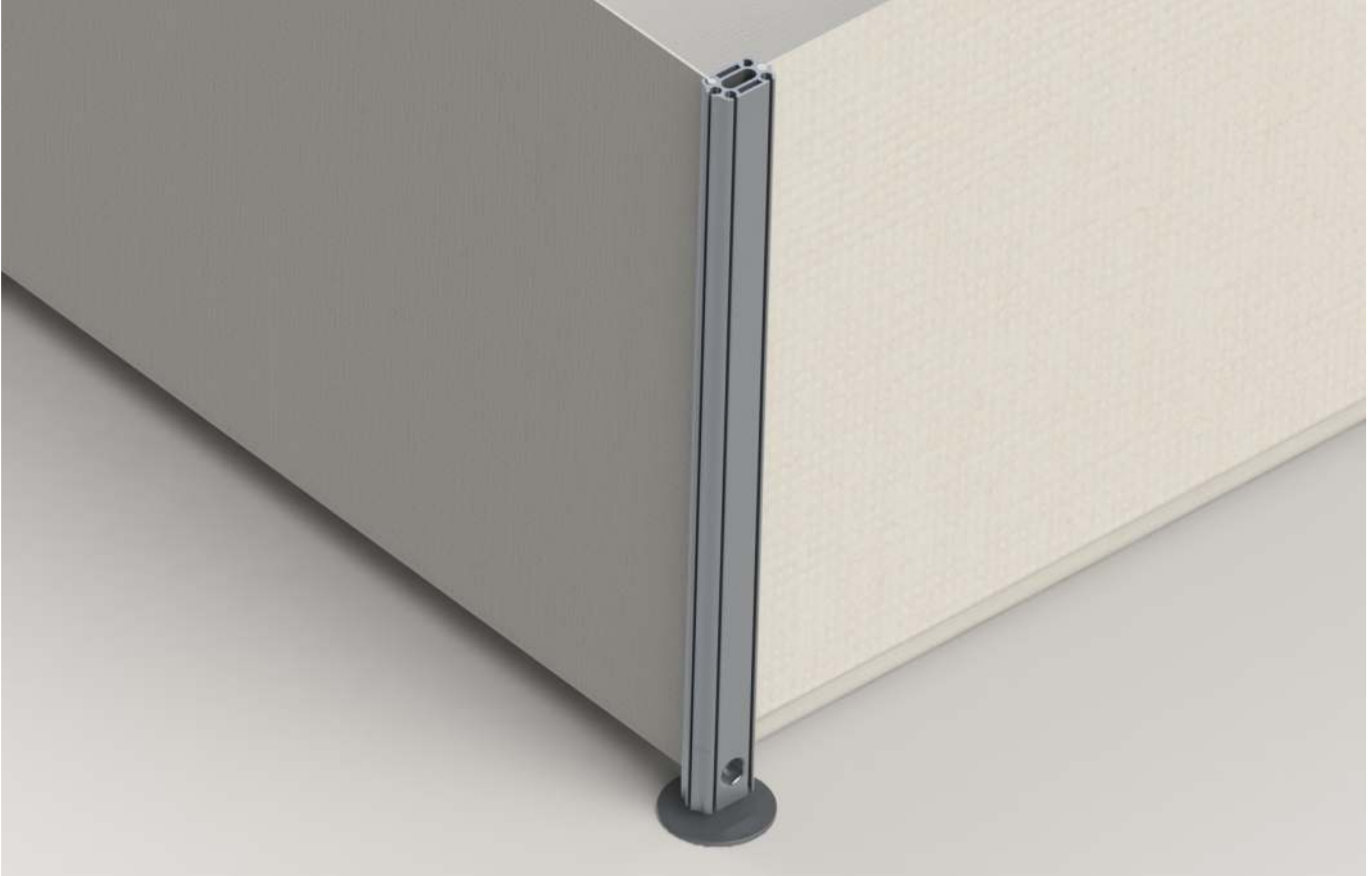

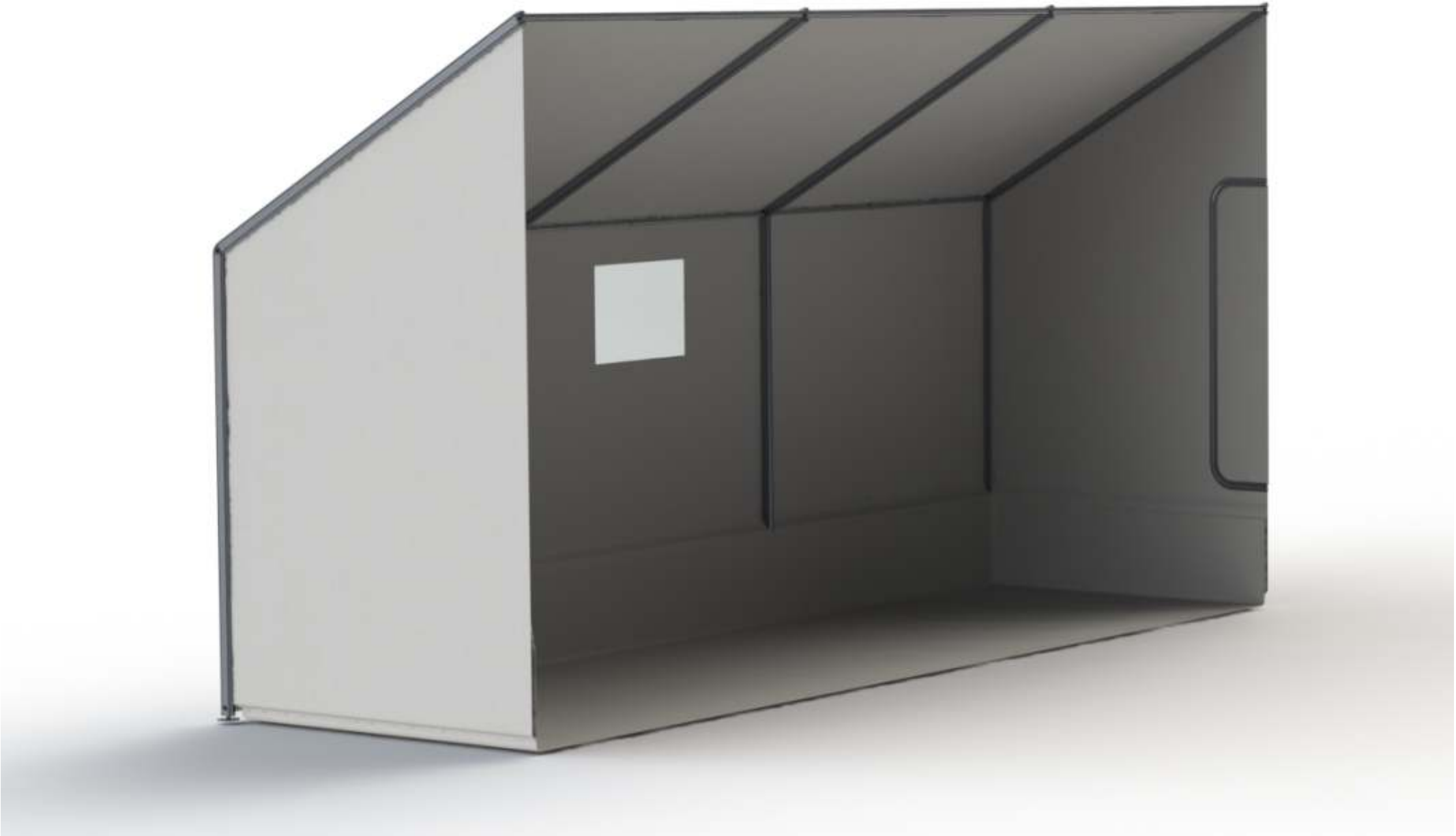

 Jahn Aamodt design
INDUSTRIAL DESIGNER MID
INTERIOR ARCHITECT NIL

ROFI transitional tent
model Freedom

www.rofi.com

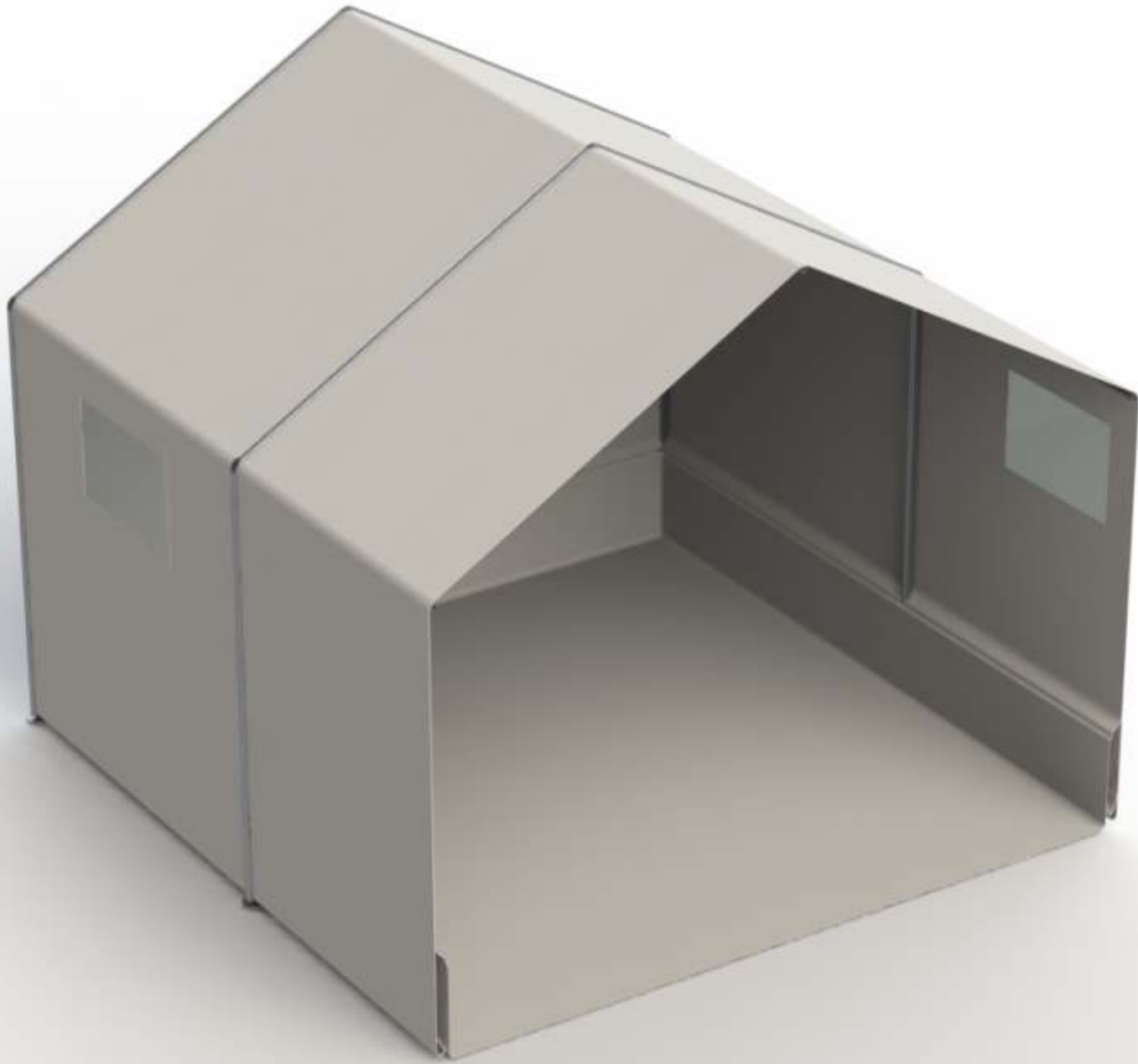

Jahn Aamodt design
INDUSTRIAL DESIGNER MID
INTERIOR ARCHITECT NIL

ROFI transitional tent
model Freedom





Jahn Aamodt design
INDUSTRIAL DESIGNER MID
INTERIOR ARCHITECT NIL

ROFI transitional tent
model Freedom



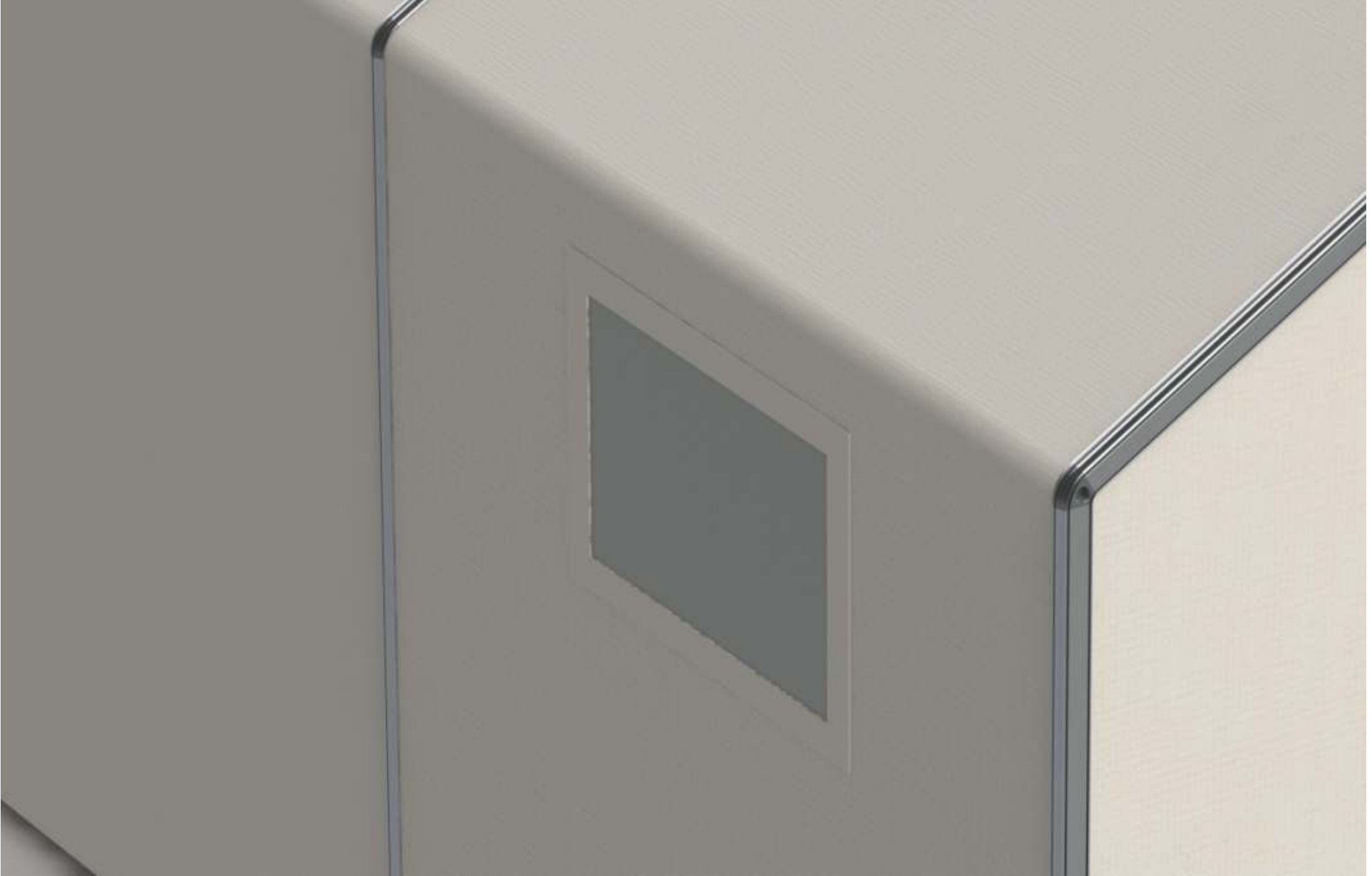

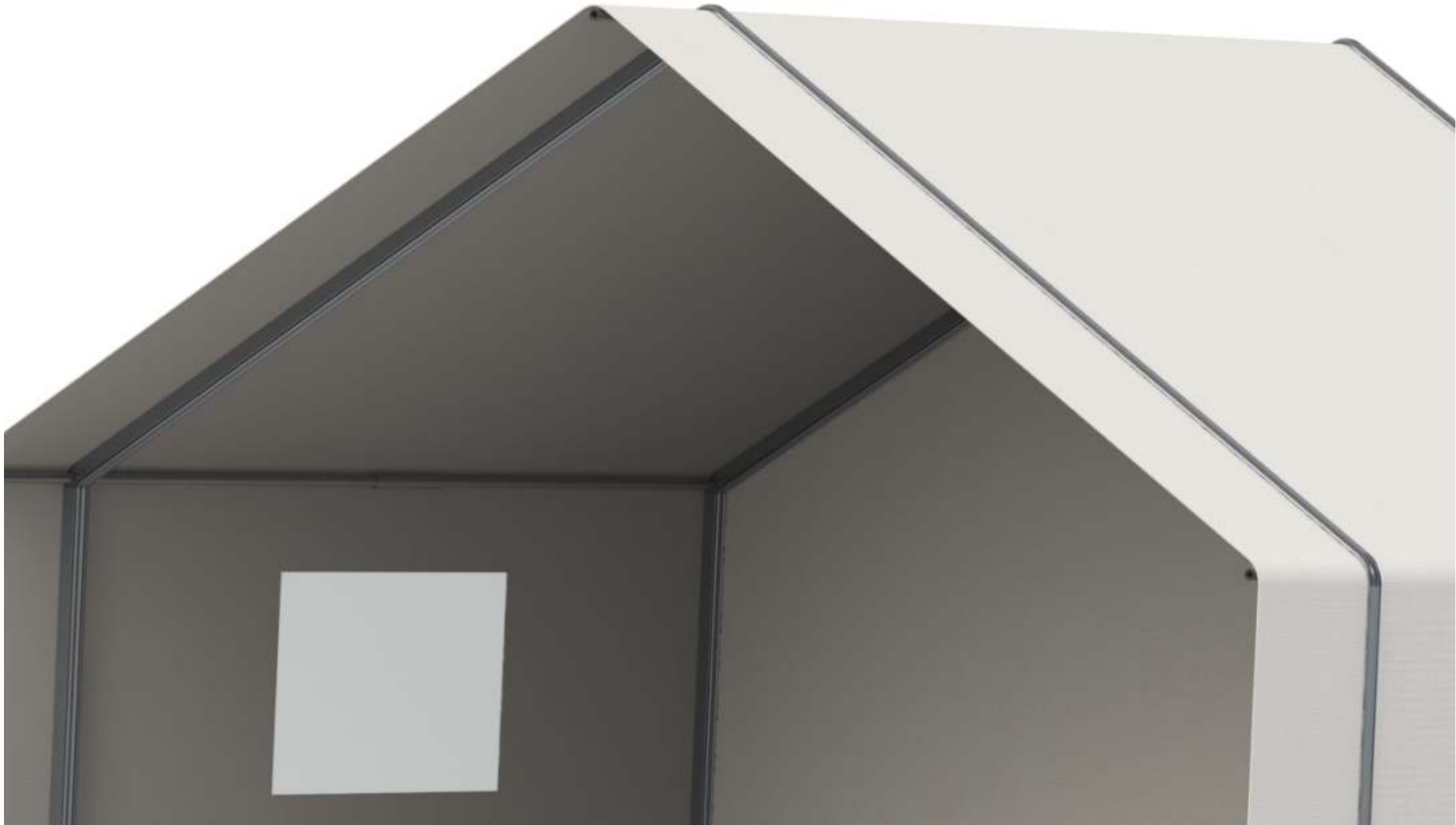

Jahn Aamodt design
INDUSTRIAL DESIGNER MID
INTERIOR ARCHITECT NIL

ROFI transitional tent
model Freedom

rofi
www.rofi.com

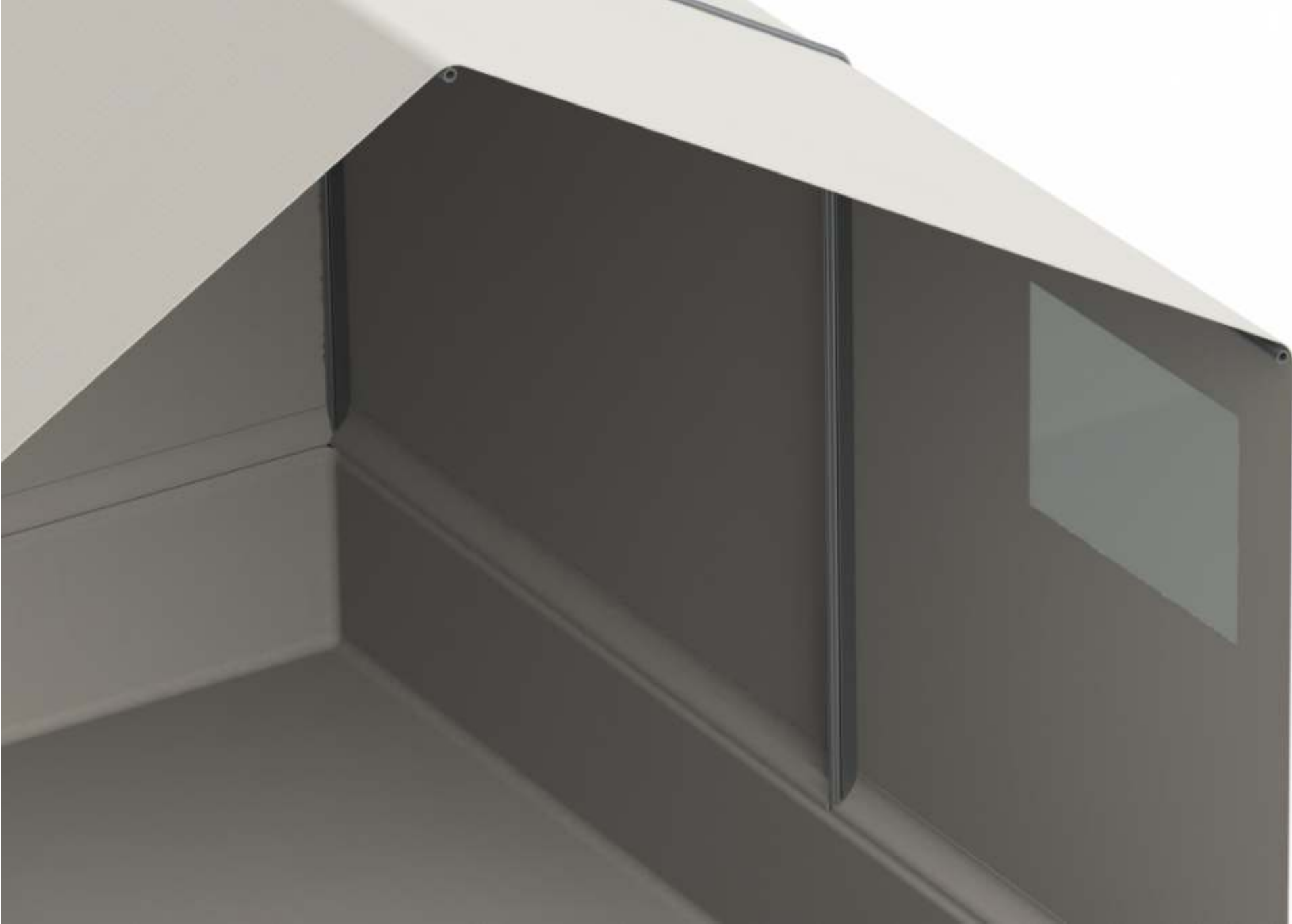

 Jahn Aamodt design
INDUSTRIAL DESIGNER MID
INTERIOR ARCHITECT NIL

ROFI transitional tent
model Freedom



www.rofi.com



Jahn Aamodt design
INDUSTRIAL DESIGNER MID
INTERIOR ARCHITECT NIL

ROFI transitional tent
model Freedom

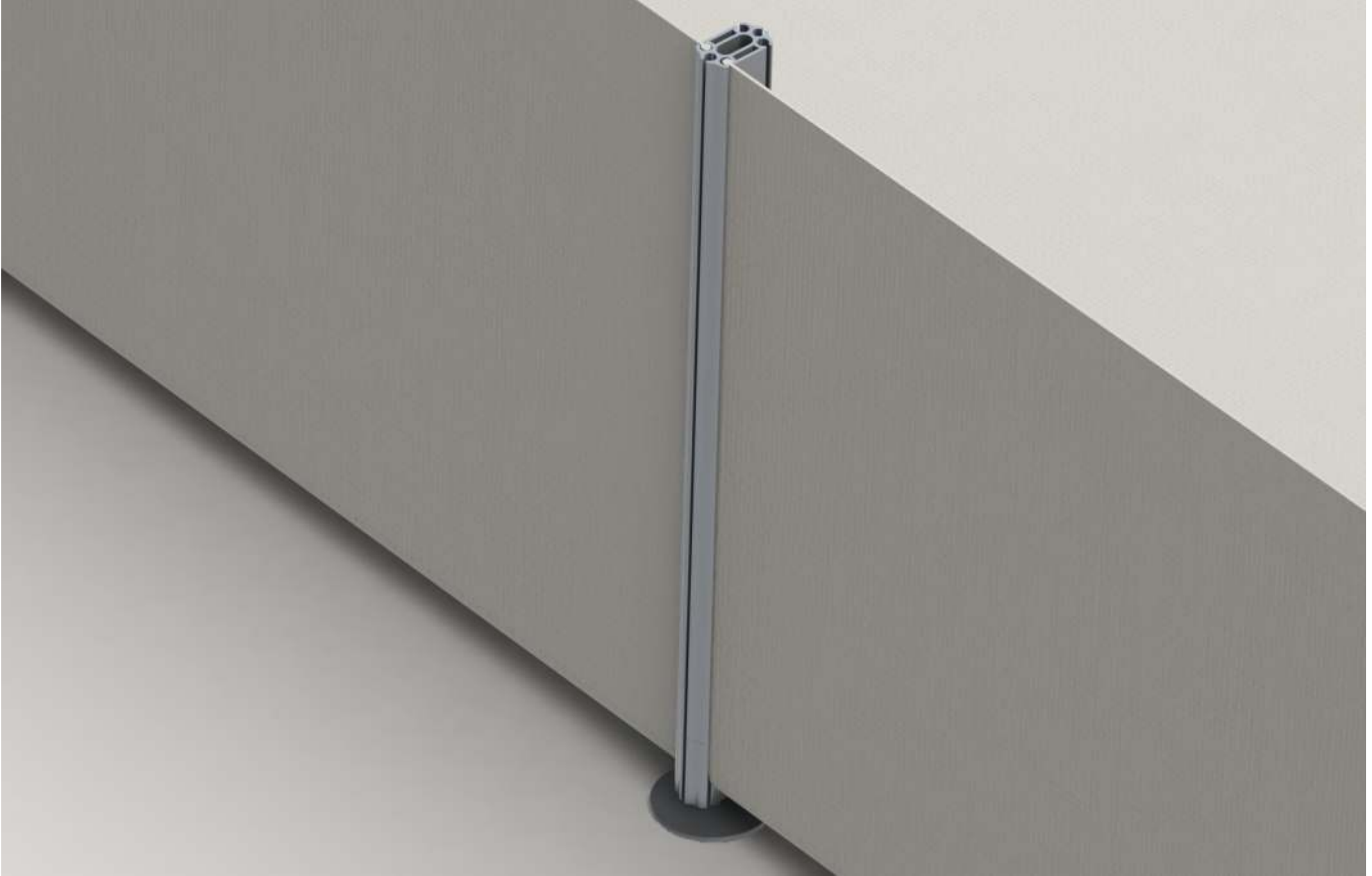
rofi
www.rofi.com



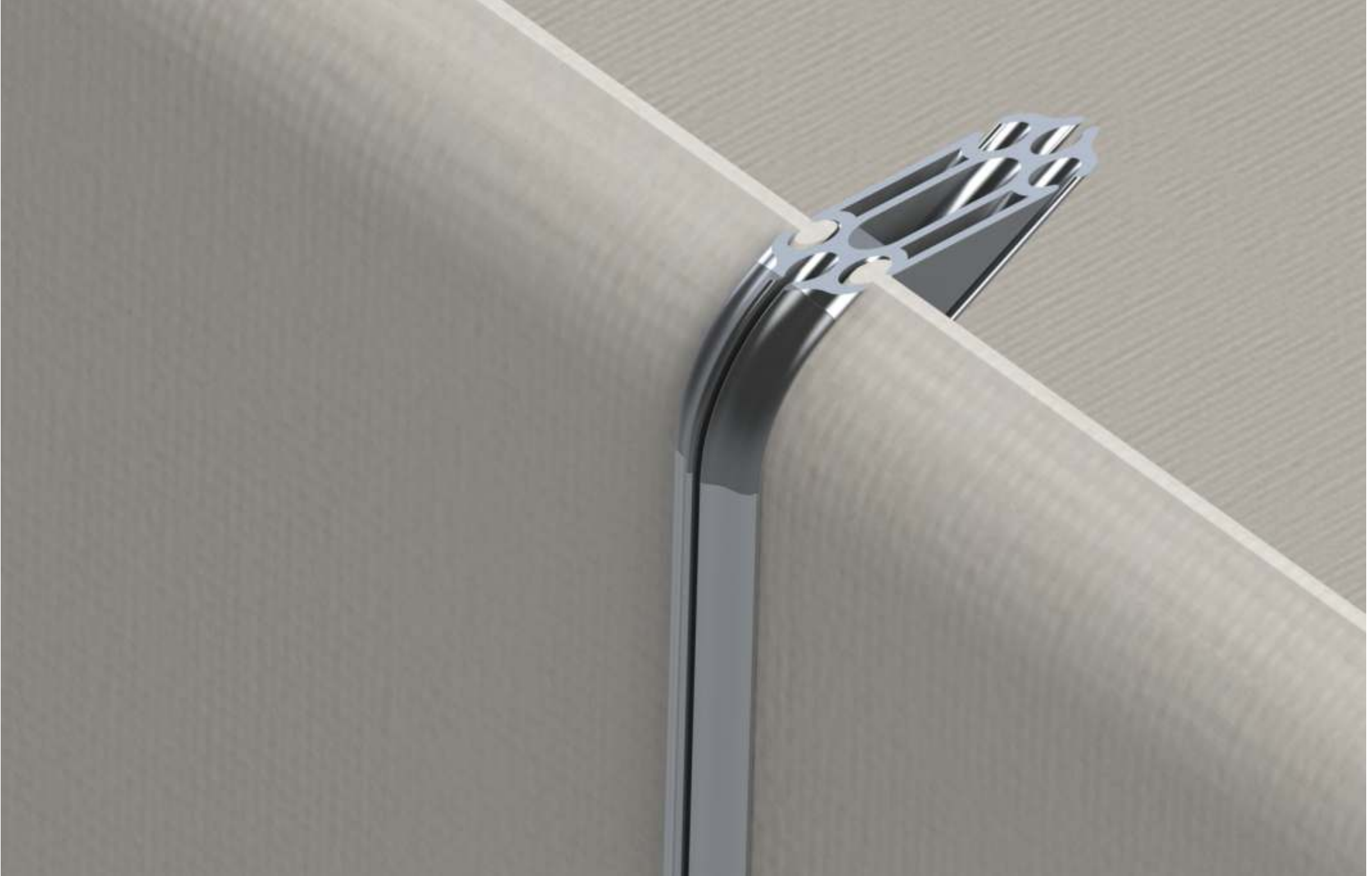

 Jahn Aamodt design
INDUSTRIAL DESIGNER MID
INTERIOR ARCHITECT NIL

ROFI transitional tent
model Freedom

www.rofi.com



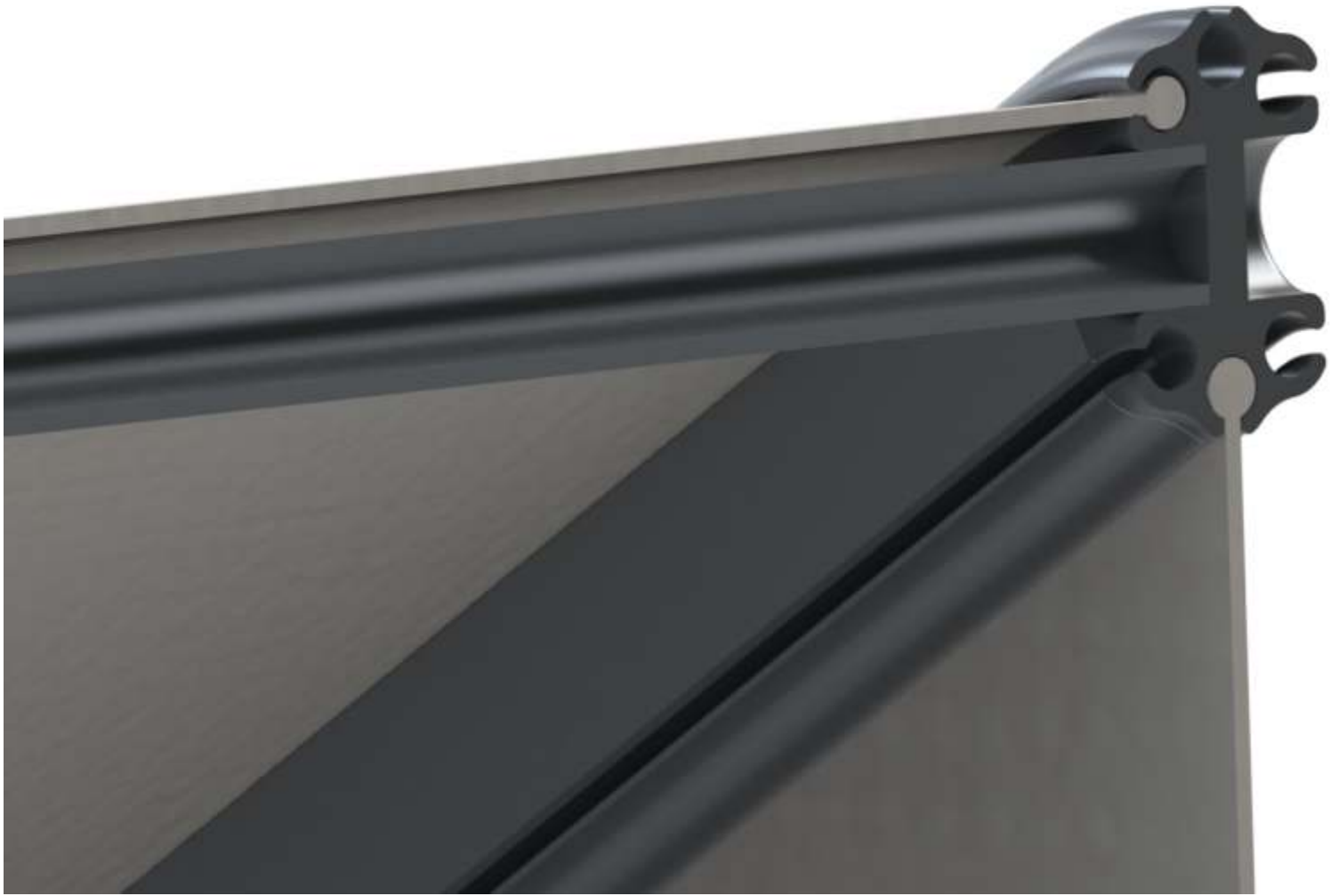

Jahn Aamodt design
INDUSTRIAL DESIGNER MID
INTERIOR ARCHITECT NIL

ROFI transitional tent
model Freedom





Jahn Aamodt design
INDUSTRIAL DESIGNER MID
INTERIOR ARCHITECT NIL

ROFI transitional tent
model Freedom



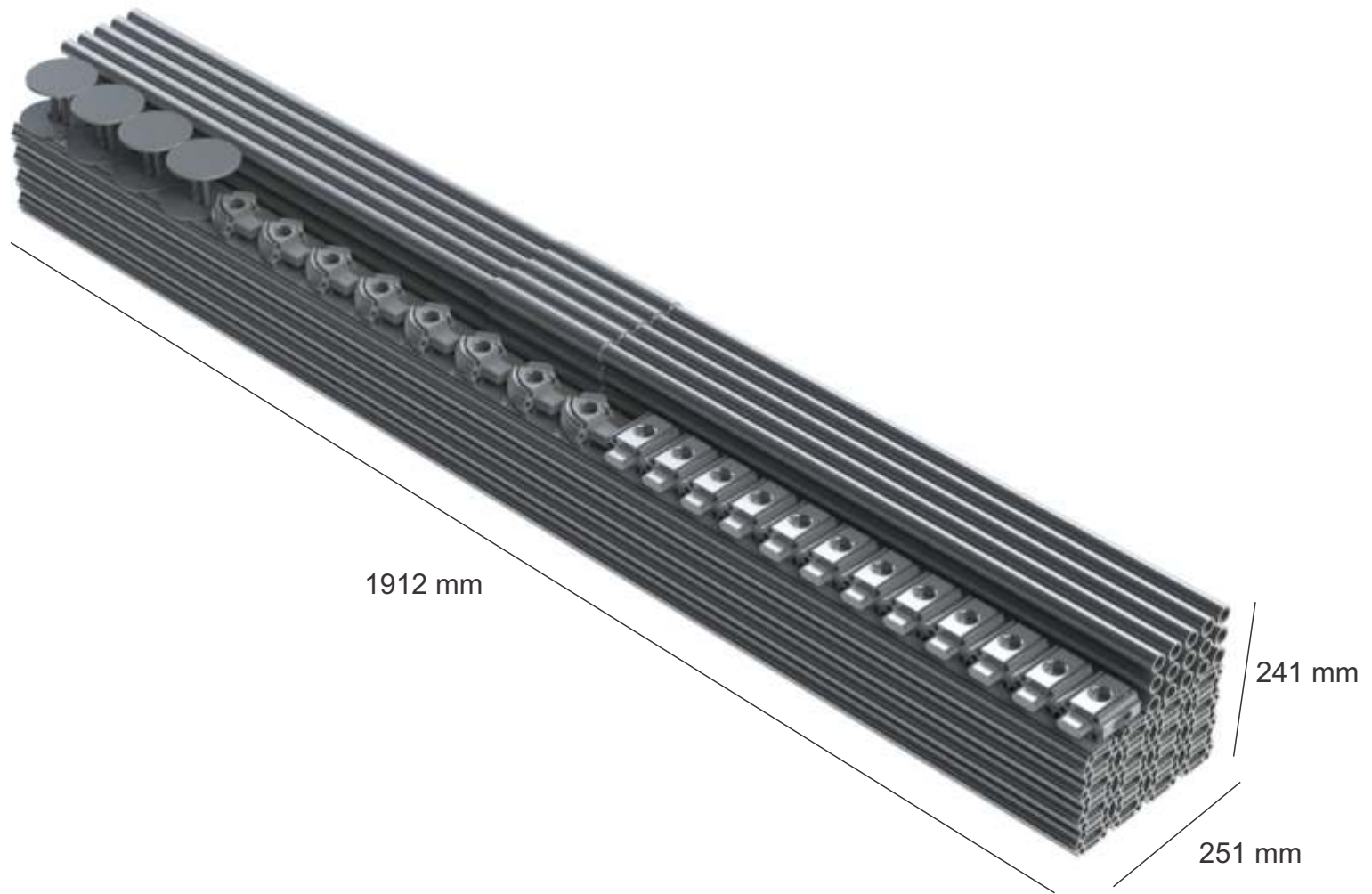

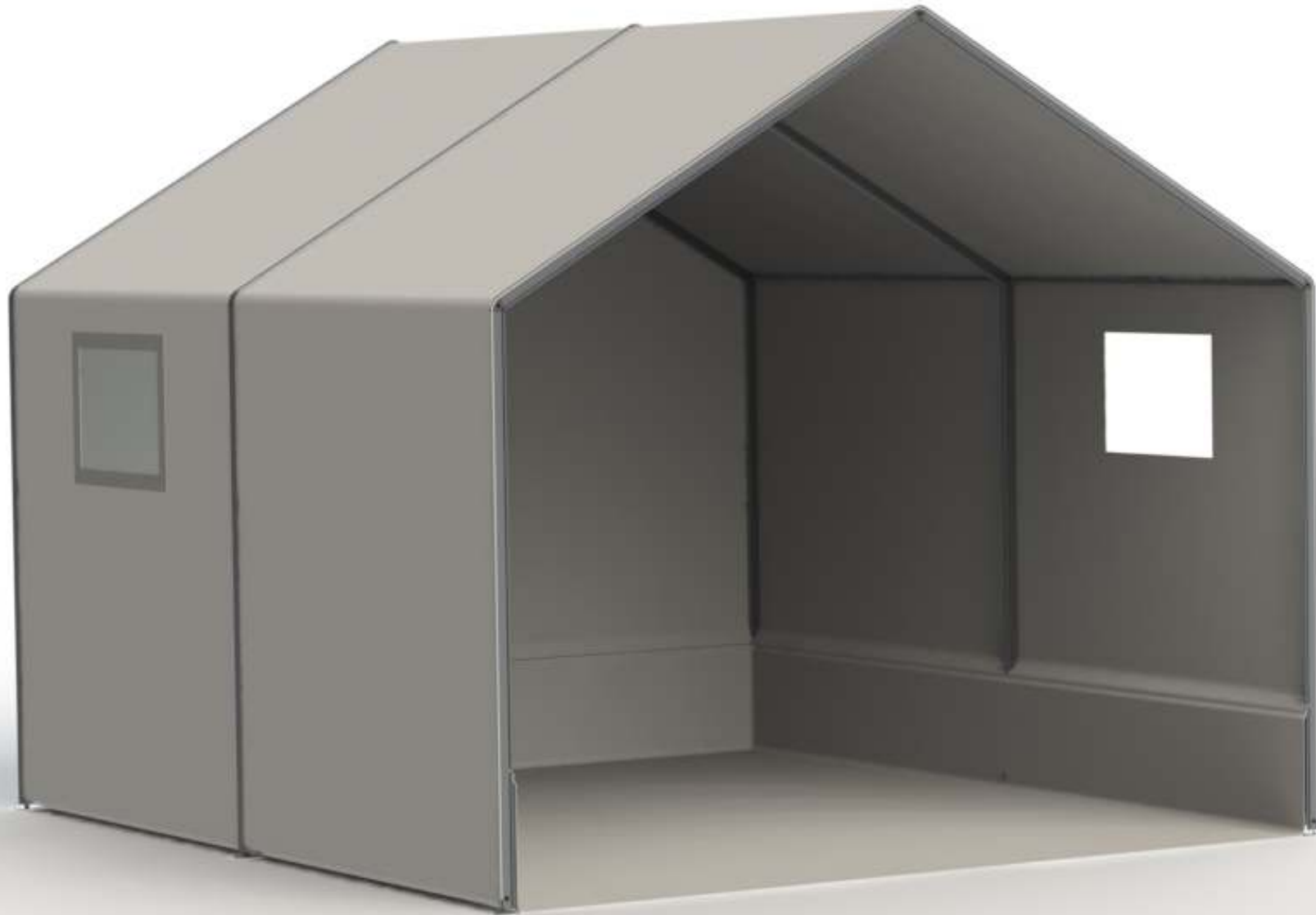

Jahn Aamodt design
INDUSTRIAL DESIGNER MID
INTERIOR ARCHITECT NIL

ROFI transitional tent
model Freedom





Jahn Aamodt design
INDUSTRIAL DESIGNER MID
INTERIOR ARCHITECT NIL

ROFI transitional tent
model Freedom



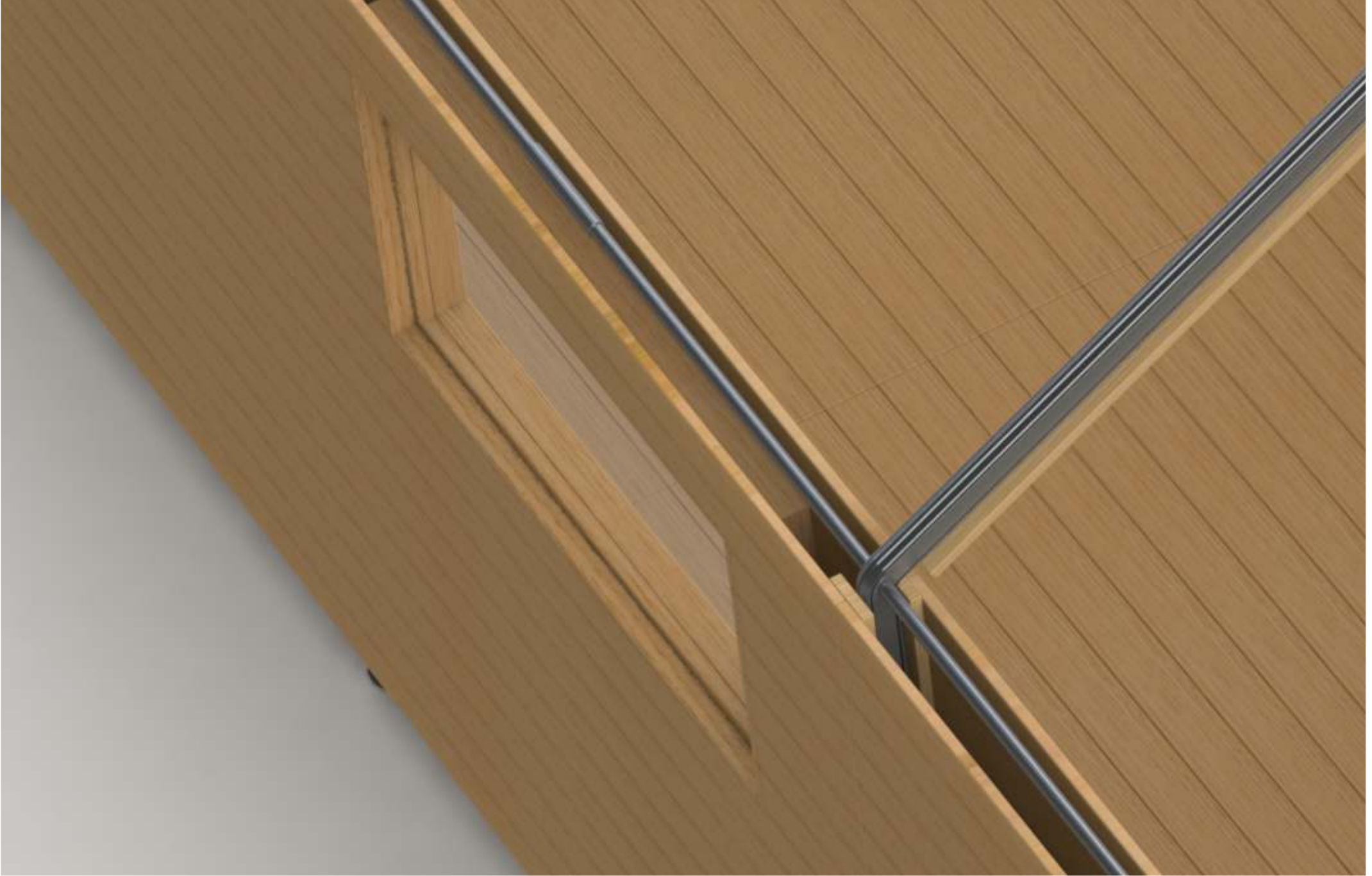



Jahn Aamodt design
INDUSTRIAL DESIGNER MID
INTERIOR ARCHITECT NIL

ROFI transitional tent
model Freedom





Jahn Aamodt design
INDUSTRIAL DESIGNER MID
INTERIOR ARCHITECT NIL

ROFI transitional tent
model Freedom

rofi

www.rofi.com



 Jahn Aamodt design
INDUSTRIAL DESIGNER MID
INTERIOR ARCHITECT NIL

ROFI transitional tent
model Freedom



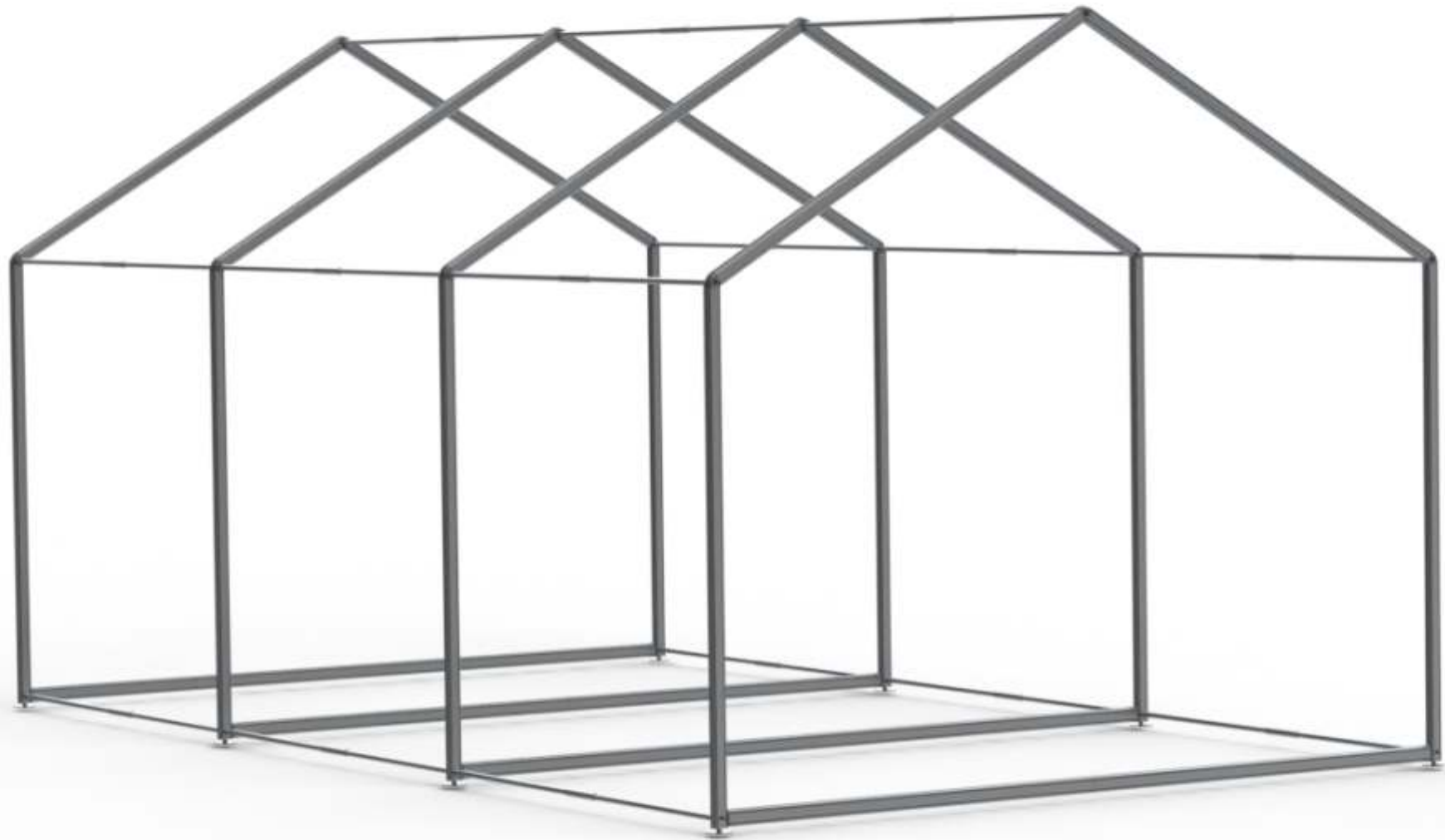

Jahn Aamodt design
INDUSTRIAL DESIGNER MID
INTERIOR ARCHITECT NIL

ROFI transitional tent
model Freedom





Jahn Aamodt design
INDUSTRIAL DESIGNER MID
INTERIOR ARCHITECT NIL

ROFI transitional tent
model Freedom



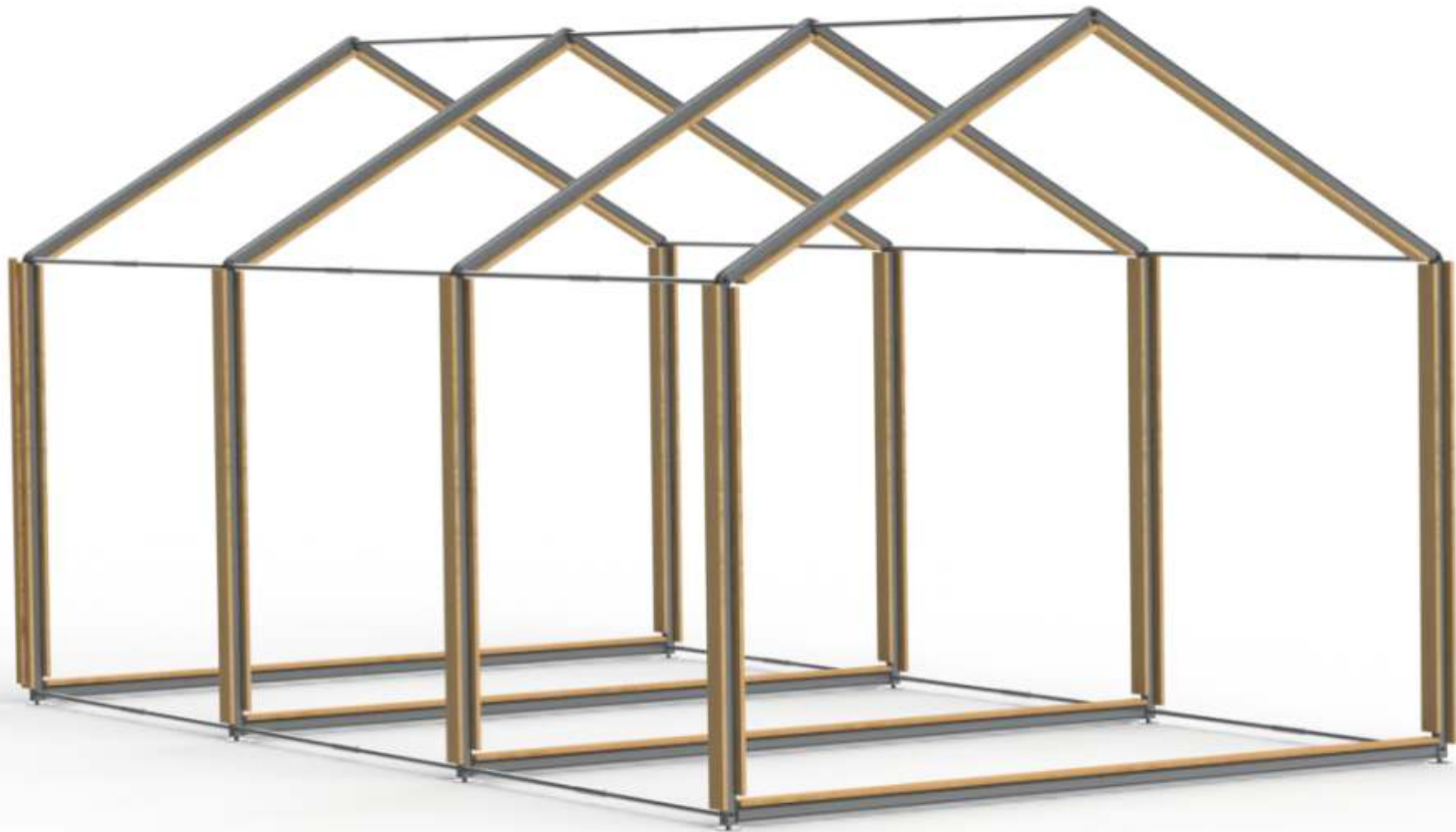

Jahn Aamodt design
INDUSTRIAL DESIGNER MID
INTERIOR ARCHITECT NIL

ROFI transitional tent
model Freedom





Jahn Aamodt design
INDUSTRIAL DESIGNER MID
INTERIOR ARCHITECT NIL

ROFI transitional tent
model Freedom





Jahn Aamodt design
INDUSTRIAL DESIGNER MID
INTERIOR ARCHITECT NIL

ROFI transitional tent
model Freedom





Jahn Aamodt design
INDUSTRIAL DESIGNER MID
INTERIOR ARCHITECT NIL

ROFI transitional tent
model Freedom







Jahn Aamodt design
INDUSTRIAL DESIGNER MID
INTERIOR ARCHITECT NIL

ROFI transitional tent
model Freedom





Jahn Aamodt design
INDUSTRIAL DESIGNER MID
INTERIOR ARCHITECT NIL

ROFI transitional tent
model Freedom





Jahn Aamodt design
INDUSTRIAL DESIGNER MID
INTERIOR ARCHITECT NIL

ROFI transitional tent
model Freedom





Jahn Aamodt design
INDUSTRIAL DESIGNER MID
INTERIOR ARCHITECT NIL

ROFI transitional tent
model Freedom





Jahn Aamodt design
INDUSTRIAL DESIGNER MID
INTERIOR ARCHITECT NIL

ROFI transitional tent
model Freedom





Jahn Aamodt design
INDUSTRIAL DESIGNER MID
INTERIOR ARCHITECT NIL

ROFI transitional tent
model Freedom





Jahn Aamodt design
INDUSTRIAL DESIGNER MID
INTERIOR ARCHITECT NIL

ROFI transitional tent
model Freedom





Jahn Aamodt design
INDUSTRIAL DESIGNER MID
INTERIOR ARCHITECT NIL

ROFI transitional tent
model Freedom

rofi
www.rofi.com

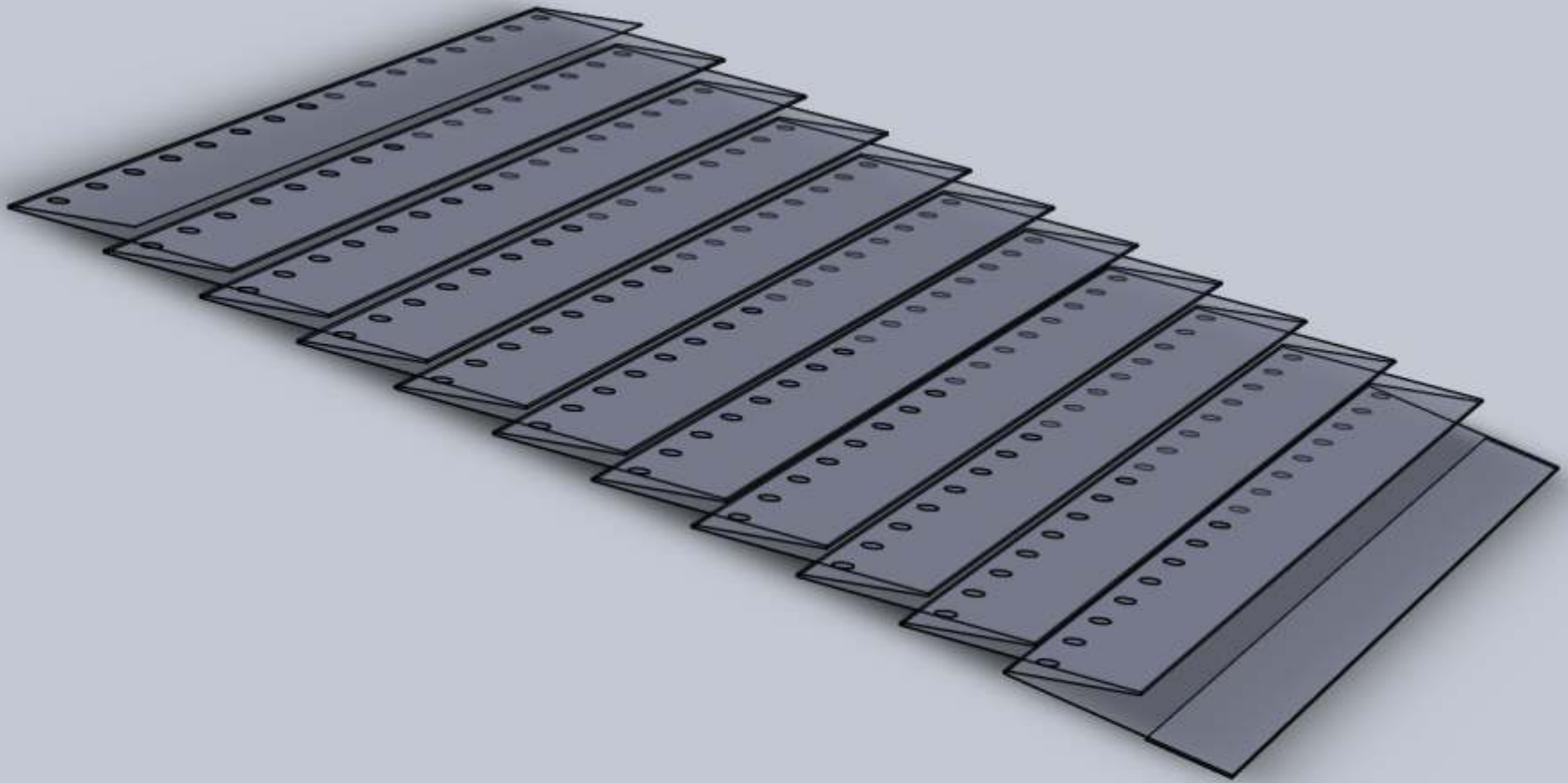

Jahn Aamodt design
INDUSTRIAL DESIGNER MID
INTERIOR ARCHITECT NIL

ROFI transitional tent
model Freedom





Jahn Aamodt design
INDUSTRIAL DESIGNER MID
INTERIOR ARCHITECT NIL

ROFI transitional tent
model Freedom





Jahn Aamodt design
INDUSTRIAL DESIGNER MID
INTERIOR ARCHITECT NIL

ROFI transitional tent
model Freedom





Jahn Aamodt design
INDUSTRIAL DESIGNER MID
INTERIOR ARCHITECT NIL

ROFI transitional tent
model Freedom





5797 mm

3003 mm

1984 mm



3429 mm



Jahn Aamodt design
INDUSTRIAL DESIGNER MID
INTERIOR ARCHITECT NIL

ROFI transitional tent
model Freedom



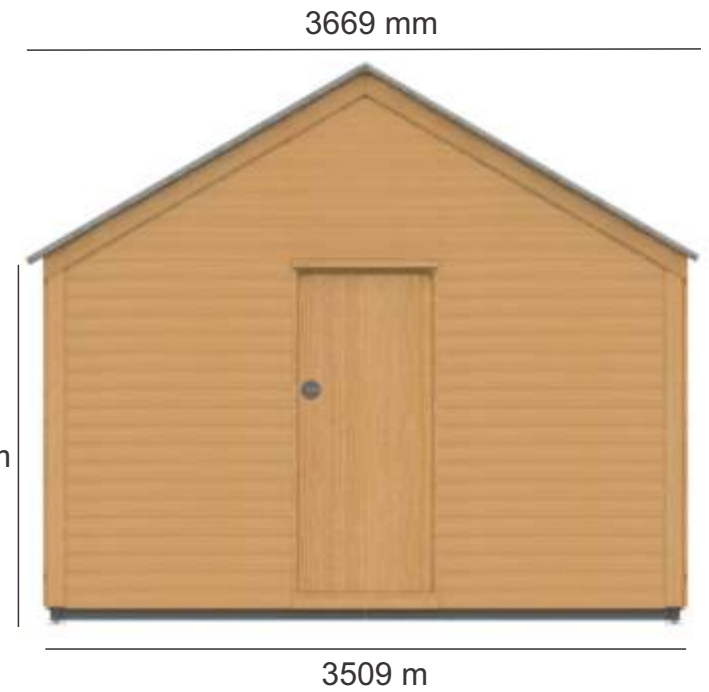

Jahn Aamodt design
INDUSTRIAL DESIGNER MID
INTERIOR ARCHITECT NIL

ROFI transitional tent
model Freedom





Jahn Aamodt design
INDUSTRIAL DESIGNER MID
INTERIOR ARCHITECT NIL

ROFI transitional tent
model Freedom





Jahn Aamodt design
INDUSTRIAL DESIGNER MID
INTERIOR ARCHITECT NIL

ROFI transitional tent
model Freedom





Jahn Aamodt design
INDUSTRIAL DESIGNER MID
INTERIOR ARCHITECT NIL

ROFI transitional tent
model Freedom





Jahn Aamodt design
INDUSTRIAL DESIGNER MID
INTERIOR ARCHITECT NIL

ROFI transitional tent
model Freedom





Jahn Aamodt design
INDUSTRIAL DESIGNER MID
INTERIOR ARCHITECT NIL

ROFI transitional tent
model Freedom





Jahn Aamodt design
INDUSTRIAL DESIGNER MID
INTERIOR ARCITECT NIL

ROFI transitional tent
model Freedom





Jahn Aamodt design
INDUSTRIAL DESIGNER MID
INTERIOR ARCHITECT NIL

ROFI transitional tent
model Freedom

rofi

www.rofi.com



Jahn Aamodt design
INDUSTRIAL DESIGNER MID
INTERIOR ARCHITECT NIL

ROFI transitional tent
model Freedom





Jahn Aamodt design
INDUSTRIAL DESIGNER MID
INTERIOR ARCHITECT NIL

ROFI transitional tent
model Freedom





Jahn Aamodt design
INDUSTRIAL DESIGNER MID
INTERIOR ARCHITECT NIL

ROFI transitional tent
model Freedom





Jahn Aamodt design
INDUSTRIAL DESIGNER MID
INTERIOR ARCHITECT NIL

ROFI transitional tent
model Freedom





Jahn Aamodt design
INDUSTRIAL DESIGNER MID
INTERIOR ARCHITECT NIL

ROFI transitional tent
model Freedom





Jahn Aamodt design
INDUSTRIAL DESIGNER MID
INTERIOR ARCHITECT NIL

ROFI transitional tent
model Freedom

rofi
www.rofi.com



Jahn Aamodt design
INDUSTRIAL DESIGNER MID
INTERIOR ARCHITECT NIL

ROFI transitional tent
model Freedom

rofi

www.rofi.com



Jahn Aamodt design
INDUSTRIAL DESIGNER MID
INTERIOR ARCHITECT NIL

ROFI transitional tent
model Freedom





Jahn Aamodt design
INDUSTRIAL DESIGNER MID
INTERIOR ARCHITECT NIL

ROFI transitional tent
model Freedom

rofi
www.rofi.com



Jahn Aamodt design
INDUSTRIAL DESIGNER MID
INTERIOR ARCHITECT NIL

ROFI transitional tent
model Freedom

rofi

www.rofi.com



Jahn Aamodt design
INDUSTRIAL DESIGNER MID
INTERIOR ARCHITECT NIL

ROFI transitional tent
model Freedom





Jahn Aamodt design
INDUSTRIAL DESIGNER MID
INTERIOR ARCHITECT NIL

ROFI transitional tent
model Freedom





Jahn Aamodt design
INDUSTRIAL DESIGNER MID
INTERIOR ARCHITECT NIL

ROFI transitional tent
model Freedom





Jahn Aamodt design
INDUSTRIAL DESIGNER MID
INTERIOR ARCHITECT NIL

ROFI transitional tent
model Freedom



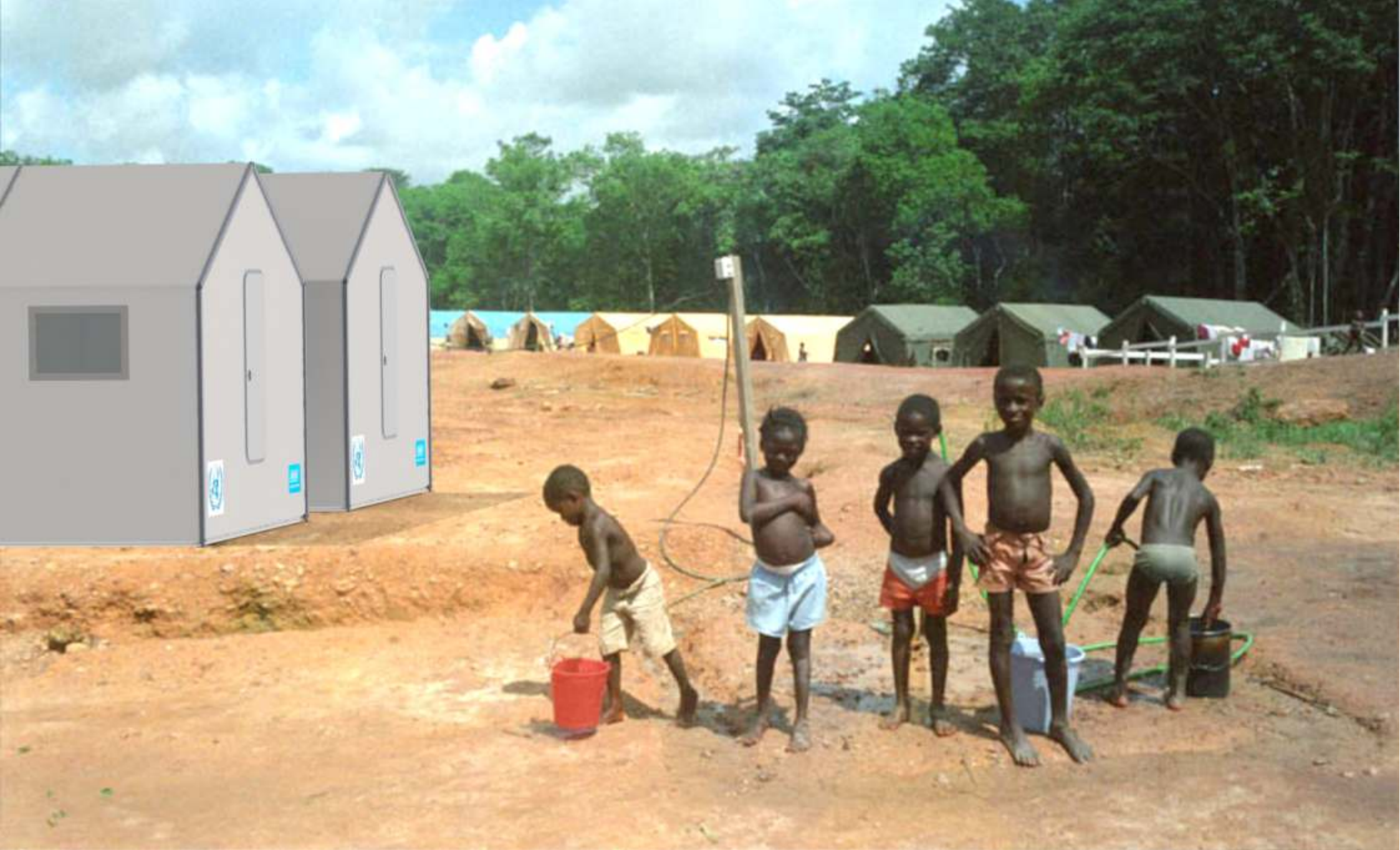

Jahn Aamodt design
INDUSTRIAL DESIGNER MID
INTERIOR ARCHITECT NIL

ROFI transitional tent
model Freedom





Jahn Aamodt design
INDUSTRIAL DESIGNER MID
INTERIOR ARCHITECT NIL

ROFI transitional tent
model Freedom





Jahn Aamodt design
INDUSTRIAL DESIGNER MID
INTERIOR ARCHITECT NIL

ROFI transitional tent
model Freedom





Jahn Aamodt design
INDUSTRIAL DESIGNER MID
INTERIOR ARCHITECT NIL

ROFI transitional tent
model Freedom



ROFI transitional tent ***model Freedom***



Jahn Aamodt design
INDUSTRIAL DESIGNER MID
INTERIOR ARCHITECT NIL

