



note **3**

Passive and Low Energy Architecture International
DESIGN TOOLS AND TECHNIQUES

THERMAL COMFORT

Andris Auliciems and Steven V. Szokolay

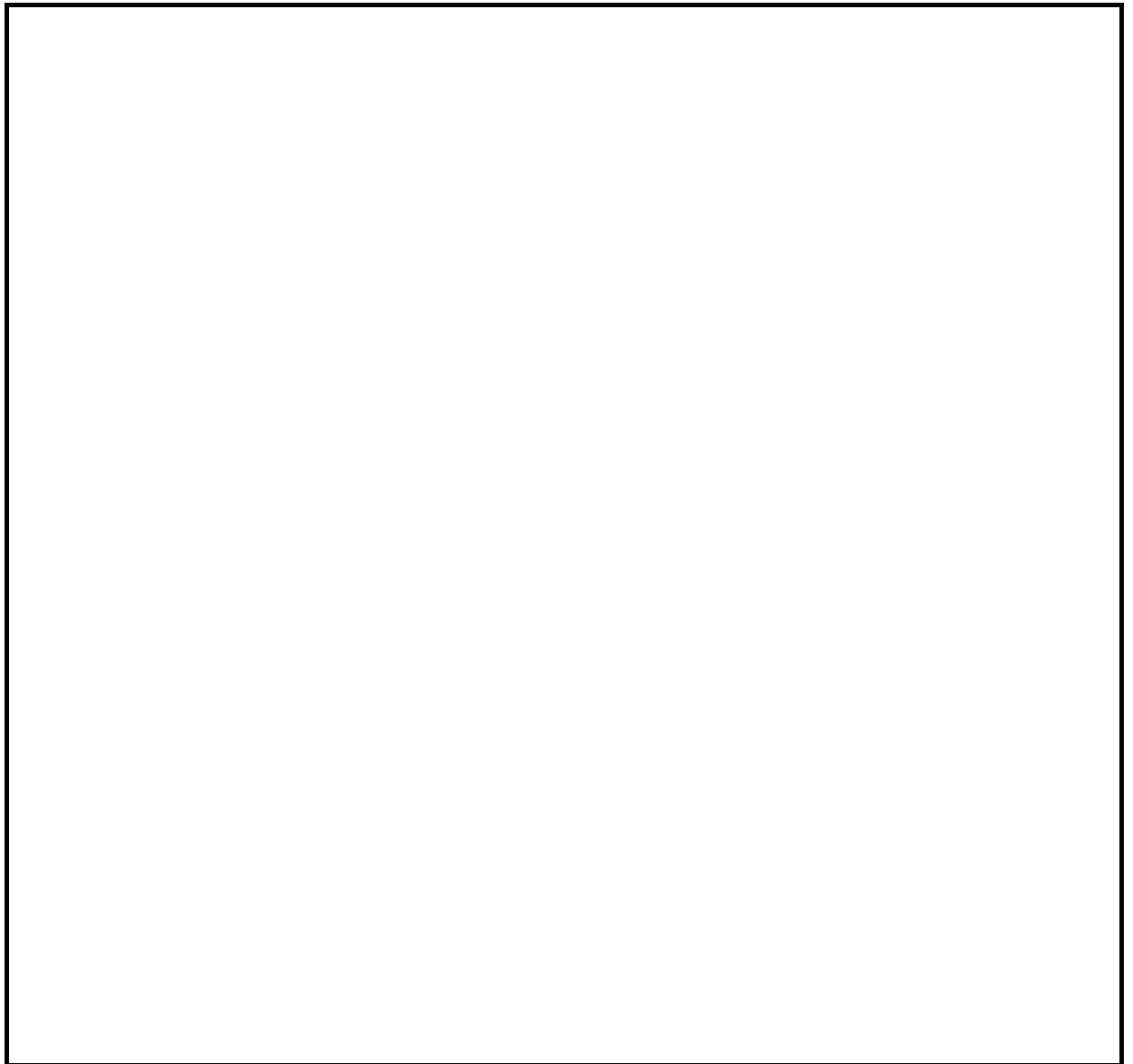

IN ASSOCIATION WITH THE UNIVERSITY OF QUEENSLAND DEPT. OF ARCHITECTURE

THERMAL COMFORT

©. Andris Auliciems and Steven V. Szokolay
all rights reserved

first published 1997
second revised edition 2007

PLEA : Passive and Low Energy Architecture International
in association with
Department of Architecture, The University of Queensland
Brisbane 4072

Andris Auliciems was associate professor in Geography (climatology) at the University of Queensland
and

Steven V. Szokolay is past Head of Department of Architecture and Director of the Architectural Science Unit
at the University of Queensland, both now retired

The manuscript of this publication has been refereed by
Michael Keniger, Head of Department of Architecture
The University of Queensland

and

Susan Roaf and Michael Humphreys, School of Architecture
Oxford Brookes University

revision and electronic version prepared by S V Szokolay

ISBN 0 86776 729 4

PREFACE

This is the third booklet in our **PLEA Notes** series. Each of these Notes is intended to deal with one particular and narrow aspect of design, of a technical / scientific nature. These Notes serve a dual purpose: to be a learning tool, introducing the subject and discussing it in mainly qualitative terms, but also to be a design tool, to provide quantitative data and methods for the consideration of the particular subject matter in design. An implicit aim is also to create an authoritative reference work, which would provide a concise but comprehensive summary of the state of the art of the subject.

In this Note 3 the undergraduate student will find part 1, then sections 2.1, 2.2 and 2.3 of part 2 as well as part 3 of particular interest. The practising designer (using the above sections as introduction) will - we hope - find part 4 most useful. The research student, or anyone interested in the whys and wherefores will find part 2 as a unique reference source.

References for the comfort index data sheets are given in footnote form, similarly in places where they refer to that page only. General references are listed in alphabetical order on pages 62 – 63.

We hope that this **Note** will contribute in some small way to the creation of better buildings, healthier indoor environments and energy conservation, thus serve the broad aims of PLEA and a sustainable future.

To the second edition

The first edition of this Note sold out in little over two years. Since then several short runs have been printed, but now it has been decided to make it available in electronic form, and through the web. We took the opportunity to correct some errors and make a few minor additions in the light of some recent publications.

Feedback from readers or suggestions are welcomed by the editor:

Steven V. Szokolay
50 Halimah St, Chapel Hill, 4069, Australia
<s.szokolay@uq.edu.au>

CONTENTS

Introduction	p. 3
1 Principles	
1.1 Historical background	5
1.2 Physiological basis	6
1.3 Factors of comfort	8
1.4 Basic psychrometry	10
1.5 Air movement	14
2 Studies and indices	
2.1 Laboratory tests and field studies	15
2.2 Heat exchange processes of the body	16
2.2.1 the two-node model	16
2.2.2 Fanger's heat balance equation	19
2.3 Physical measures	21
2.4 Measures of comfort: empirical indices	
2.4.1 effective temperature (ET)	22
2.4.2 corrected effective temperature (CET)	23
2.4.3 wet bulb globe temperature (WBGT)	24
2.4.4 operative temperature (OT)	25
2.4.5 equivalent temperature (EqT)	26
2.4.6 equivalent warmth (EqW)	26
2.4.7 resultant temperature (RT)	27
2.4.8 equatorial comfort index (ECI)	28
2.4.9 tropical summer index (Tsi)	29
2.5 Measures of comfort: analytical indices	
2.5.1 thermal strain index (TSI)	30
2.5.2 thermal acceptance ratio (TAR)	30
2.5.3 predicted 4-hour sweat rate (P4SR)	31
2.5.4 heat stress index (HSI)	32
2.5.5 relative strain index (RSI)	33
2.5.6 index of thermal stress (ITS)	34
2.5.7 predicted mean vote (PMV)	35
2.5.8 new effective temperature (ET*)	36
2.5.9 standard effective temperature (SET)	39
2.5.10 subjective temperature (ST)	40
2.5.11 index of thermal sensation (TS and DISC)	41
2.6 Discussion of indices	42
2.7 Non-uniform environments	43
3 Recent developments	
3.1 Adaptation	45
3.1.1 Review of field studies	45
3.1.2 An adaptive model of comfort	46
3.1.3 Acclimatization	49
3.2 Consequences of discomfort	50
3.2.1 Discomfort, behaviour and health	50
3.2.2 Atmospheric impacts on morbidity...	51
3.3 Comfort management systems	52
4 Practice	
4.1 The 'comfort zone' from Olgyay to ASHRAE	55
4.2 Recommended working method	59
Conclusion	62
References	62
Appendix 1 An example for the 2-node model	64
Index	65

INTRODUCTION

Before contemplating what would constitute a good thermal design, in an age where much of our thinking is concerned with utility and cost reduction, with globalization of custom and knowledge, we might be wise and reconsider the human condition entering the 21st Century.

In general, the proliferation of western lifestyles, clothing, technology in building construction and microclimate control have tended towards homogenizing indoor environments to which humans are exposed. These developments may be driven by market forces, but the result is that humans are becoming adapted to a very narrow band of conditions. In a global ecosystem increasingly threatened by environmental degradation and anthropogenic climate change, such specialization in adaptation needs to be examined in terms of

- a) sustainability over the longer term, and
- b) the overall "biological fitness", or adaptability of the human species.

Here, we need to be mindful of the broad principle that, within a changing environment, survivability is greater among the *adaptable* than the *adapted* and ask which trend is being favoured by technological development and thermal design ?

Humans have a fairly broad adaptability, a capacity for acclimatization to different conditions, but we can become "spoilt". Living in artificially maintained and homogenised environments would reduce this adaptability, the limits of survival would be narrowed.

If architectural design is to serve the future users of the product, the building, it must provide (*inter alia*) a favourable thermal environment. Overall, a precondition of human well-being in terms of both productivity and health, appears to be the achievement of a harmonious balance between minimization of physiological responses (that is, the state that we subjectively interpret as thermal "comfort"), and maximization of acclimatization.

Thus, while the first step of thermal design must be to establish what is the range of thermal conditions commensurate with comfort, we must go beyond this basic concern and create conditions that also permit conditions to become stimulating, without causing ill effects to the occupants. Thus we need to be aware of both the potential dangers of "overshooting", and of the need to investigate activity and site-specific conditions that are compatible with comfort, but also facilitate acclimatization.

In this Note part 1 examines the physical and physiological basics; part 2 gives a detailed account of comfort studies and a somewhat encyclopaedic description of a range of comfort indices; part 3 discusses recent developments: the present day broadening of views and part 4 deals with practical (architectural) applications. The 'conclusions' set the topic into context: give an outline of the bigger picture.

Symbols and abbreviations

A_{cl}	clothed body surface area [25]	R	radiation [6]
A_D	DuBois area [6]	RH	relative humidity [8]
A_{eff}	effective area [20]	RSI	relative strain index [33]
AH	absolute humidity [8]	RT	resultant temperature [27]
ASHRAE	Am.Soc.Heat. Refrig.Aircond.Engrs.[15]	S	storage [6]
ASHVE	Am.Soc.Heat.Vent.Engrs.[5, 22]	SET	standard effective temperature [39]
A_{sw}	area covered by sweat [17]	SH	saturation humidity [10]
C or C_v	convection [6]	ST	subjective temperature [40]
C_d	conduction [6]	T	temperature [38]
CET	corrected effective temperature [23]	TAR	thermal acceptance ratio [30]
CIBSE	Chart.Inst.of Bldg.Serv. Engrs.(UK) [21]	T_b	body temperature [39]
C_{resp}	respiration convection [17]	THI	temperature-humidity index [21]
DBT	dry bulb temperature [8]	T_i	indoor temperature [45]
DISC	discomfort index [41]	TL	thermal load [35]
DPT	dew-point temperature [11]	T_m	mean temperature [45]
DRT	dry resultant temperature [21]	TS	thermal sensation [41]
E	evaporation heat loss [6]	Tsi	tropical summer index [29]
E_{diff}	diffusion through skin and clothes [17]	TSI	thermal strain index [30]
ECL	equatorial comfort index [28]	V	pulmonary ventilation rate [19]
EnvT	environmental temperature [21]	WBT	wet bulb temperature [10]
E_{max}	maximum possible evaporation [17]	W	metab. rate converted to work [34]
E_{qT}	equivalent temperature [26]	WBGT	wet bulb globe temperature [24]
E_{qW}	equivalent warmth [26]	WCI	wind chill index [21]
E_{reqd}	evaporation required [32]	WCT	wind chill temperature [21]
E_{resp}	evaporation through respiration [17]	clo	unit of clothing insulation [9]
E_{rsw}	evap. in regulatory sweating [17]	f	cooling efficiency of sweating [34]
E_{sk}	evaporation from skin [17]	f_{cl}	fraction of body clothed [20]
ET	effective temperature [22]	h	$h_c + h_r$ [17] or height [6] or hour
ET*	new effective temperature [36]	h_c	convection surf. conductance [17]
F_{cl}	insulation value of clothing [18]	h_{cl}	clothing surface conductance [17]
F_{pcl}	vapour permeance of clothing (skin-to-air) [17]	h_e	evaporation heat loss coeff. [17]
GT	globe temperature [8]	h_r	radiation conductance [17]
H	heat (enthalpy)[11] or metabolic heat [19]	m	permeance of skin [19]
H_a	heat acceptance [30]	met	unit of metabolic rate [6]
HL	latent heat [11]	p_a	vapour pressure of ambient air [17]
HR	humidity ratio [10]	p_{sk}	vapour pressure at skin temp. [17]
HS	sensible heat [11]	pt	total barometric pressure [10]
HSI	heat stress index [32]	pv	vapour pressure [10]
HVAC	heating, ventilation, air cond'ing [45]	pvs, ps	saturation vapour pressure [10,18]
I_{cl}	insulation of clothing [19]	p_{sk}	pvs at skin temperature [17]
IHVE	Inst.of Heat'g Vent'g. Engrs.(UK)[27]	sv	specific volume [11]
ITS	index of thermal stress [34]	t_a	air temperature [17]
K	conduction through clothing (skin to air) [20]	t_{cl}	temperature of clothing surface [20]
L	sensible (dry) heat loss, respiration [19]	t_r	=MRT, mean radiant temperat're [20]
M	metabolic rate [6, 16] or mass [6]	t_s, t_{sk}	skin temperature [19]
M_{sk}	metabolic heat that reaches skin [17]	v	velocity of air flow (wind) [8]
MRT	mean radiant temperature [8]	W_{rsw}	skin wettedness (regul. sweating)[17]
OT	operative temperature [25]	α	clothing surface coefficient [34]
PMV	predicted mean vote [35]	Δ	difference, change (e.g. ΔS) [6]
PPD	predicted percentage dissatisfied [35]	ϵ	emittance [20]
P4SR	predicted 4-hour sweat rate [31]	η	efficiency [16]
		λ	latent heat of evapor. of water [19]
		σ	Stefan-Boltzmann rad. constant [20]

Numbers in brackets [] refer to the page where the term is defined or the place of its principal use.

PART 1 PRINCIPLES

1.1 Historical background

Socrates, around 400 BC had some thoughts on the climatic suitability of houses, on how to build to ensure thermal comfort. Vitruvius (1st century BC) also wrote about the need to consider climate in building design, for reasons of health and comfort. This however had very little influence on the practice of architecture.

Up to the Industrial Revolution thermal comfort was not a practical issue, as there were very few tools at our disposal to influence it. When it was cold, a fire was lit to ameliorate the conditions. When it was hot, the use of hand-held fans was the only relief, or perhaps larger fans operated by obedient servants. The heat storage capacity of caves was sometimes used for cooling, or - in some cultures - man-made tunnels and ventilating towers were used for similar purposes. The potential of available controls was the limiting factor, there was no risk of overheating in winter or over-cooling in summer.

Heating technology improved from the late 18th century onwards and mechanical cooling became a possibility early 20th century. Although Heberden (early 19th century) recognised that air temperature is not the only cause of thermal sensation, that humidity is a contributing factor, the first serious study on comfort (especially the effect of high temperatures) was carried out by Haldane in England (1905). The impetus for comfort research came from engineers: it was now possible to overheat or overcool buildings, so it was necessary to establish design temperatures.

In the early 1920s Houghten and Yagloglou (1923) at the ASHVE (American Society of Heating and Ventilating Engineers) laboratories attempted to define the 'comfort zone'. In England the motivation came from industrial hygiene: the limits of environmental conditions for work. Vernon and Warner (1932) and later Bedford (1936) carried out empirical studies among factory workers. Analytical work started in the US in the mid-1930s, where Winslow, Herrington and Gagge (1937) made a significant contribution.

During and after World War 2 research activity increased and many disciplines became involved besides engineering, from physiology and medicine to geography and climatology. In architecture Victor Olgyay (1963) was the first to bring together findings of the various disciplines and interpret these for practical (architectural) purposes.

Before this there were two extreme approaches to design:

- architecture considered thermal factors (at best) in qualitative terms only
- engineering design of mechanical installations was based on 'design temperatures', to establish the required plant capacity for the 'worst conditions' - the plant can then be run on partial load, albeit at a very low energy efficiency.

Today's attitudes can best be reflected by a conversation between two professionals (after the 'energy crisis' of the 1970s): *Engineer*: "I can't understand why you architects try to expropriate energy issues in building; after all it is our equipment that uses the energy." *Architect*: "yes, but if I do a good building, I would not need your b.... equipment ! "

The first step of thermal design must be to establish what the required conditions would be: the limits of thermal comfort.

THERMAL COMFORT

1.2 Physiological basis

The human body continuously produces heat. This metabolic heat production can be of two kinds:

- basal metabolism, due to biological processes which are continuous and non-conscious
- muscular metabolism, whilst carrying out work, which is consciously controllable (except in shivering).

Table 1 shows some typical metabolic rates, which can be expressed as power density, per unit body surface area (W/m^2), as the power itself for an average person (W) or in a unit devised for thermal comfort studies, called the **met**. 1 met = $58.2 W/m^2$. For an average sized man this corresponds to approximately 100 W. Du Bois (1916) proposed an estimate of the body surface area, on the basis of body mass (M , in kg) and height (h , in m), which is referred to as the "DuBois area" (m^2):

$$A_D = 0.202 M^{0.425} h^{0.725}$$

e.g. for a person of 1.7 m height and 70 kg body mass

$$A_D = 0.202 \cdot 70^{0.425} \cdot 1.7^{0.725} = 1.8 m^2$$

TABLE 1 Metabolic rates at different activities

activity	met	W/m^2	$W(av)$
sleeping	0.7	40	70
reclining, lying in bed	0.8	46	80
seated, at rest	1.0	58	100
standing, sedentary work	1.2	70	120
very light work (shopping, cooking, light industry)	1.6	93	160
medium light work (house~, machine tool ~)	2.0	116	200
steady medium work (jackhammer, social dancing)	3.0	175	300
heavy work (sawing, planing by hand, tennis) up to	6.0	350	600
very heavy work (squash, furnace work) up to	7.0	410	700

The heat produced must be dissipated to the environment, or a change in body temperature will occur. The deep body temperature is about $37^\circ C$, whilst the skin temperature can vary between $31^\circ C$ and $34^\circ C$ under comfort conditions. Variations occur in time, but also between parts of the body, depending on clothing cover and blood circulation. There is a continuous transport of heat from deep tissues to the skin surface, from where it is dissipated by radiation, convection or (possibly) conduction and evaporation.

The body's heat balance can be expressed as

$$M \pm R \pm Cv \pm Cd - E = \Delta S \text{ (W)} \quad \dots 1.1)$$

where M = metabolic rate Cv = convection

R = net radiation Cd = conduction

E = evaporation heat loss ΔS = change in heat stored

If ΔS is positive, the body temperature increases, if negative, it decreases. The heat dissipation rate depends on environmental factors, but the body is not purely passive, it is *homoeothermic*: it has several physiological regulatory mechanisms.

To **warm conditions** (or increased metabolic heat production) the body responds by *vasodilation*: subcutaneous blood vessels expand and increase the skin blood supply, thus the skin temperature, which in turn increases heat dissipation. If this cannot restore thermal equilibrium, the sweat glands are activated, the evaporative cooling mechanism will operate. Sweat can be produced for short periods at a rate of 4 L/h, but the mechanism is fatigable.

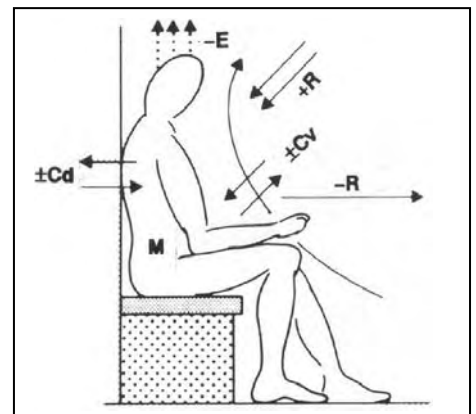

Fig.1 Heat exchanges of the human body

THERMAL COMFORT

The sustainable rate is about 1 L/h. Evaporation is an endothermic process, it absorbs heat at the rate of some 2.4 MJ/L (= 666 Wh/L).

When these mechanisms cannot restore balance conditions, inevitable body heating, *hyperthermia* will occur. When the deep body temperature reaches about 40°C, heat stroke may develop. This is a circulatory failure (venous return to the heart is reduced) leading to fainting. Early symptoms are: fatigue, headache, dizziness when standing, loss of appetite, nausea, vomiting, shortness of breath, flushing of face and neck, rapid pulse rate (up to 150/min), glazed eyes, as well as mental disturbances, such as poor judgement, apathy or irritability.

At heat stroke the temperature rapidly rises to over 41°C, sweating stops, coma sets in and death is imminent. Even if a person is saved at this point, the brain may have suffered irreparable damage. At about 42°C death would probably occur.

To **cold conditions** the response is firstly *vasoconstriction*: reduced circulation to the skin, lowering of skin temperature, thus reduction of heat dissipation rate. (Associated with this goose-pimples may appear, an atavistic phenomenon: the erection of hair, which would make the fur a better thermal insulator.) If this is insufficient, thermogenesis will take place: muscular tension or shivering, thus increased metabolic heat production.

Shivering can cause up to tenfold increase in heat production. The deep-body tissues remain at the normal 37°C. Body extremities, fingers, toes, ear lobes may be starved of blood and may reach temperatures below 20°C, or in severe exposure may even freeze, before deep body temperature would be affected.

When these physiological adjustments fail to restore thermal equilibrium, *hypothermia*, i.e. inevitable body cooling will occur. The deep body temperature may drop to below 35°C. Death usually occurs between 25 and 30°C (except under medically controlled conditions). Even if hypothermia is not reached, continued exposure to cold conditions, which require full operation of vasomotor and thermogenetic controls, can cause mental disturbances (insufficient blood supply to the brain); willpower is "softened" and conscious control gives way to hallucinations, drowsiness and stupor (Lee, 1980; Grubich, 1961).

Table 2 summarises the critical body temperatures. The skin should always be at a temperature less than the deep body, and the environment should be below the skin temperature, in order to allow adequate, but not excessive heat dissipation. The environmental conditions which allow this, would ensure a sense of physical well-being and may be judged as comfortable.

TABLE 2 Critical body temperatures (an approximate guide)

Skin temperature	Deep body temperature	Regulatory zone
pain: 45°C	42°C	death
	40°C	hyperthermia
31- 34°C	37°C	evaporative zone
		vasodilation
	comfort	
	vasoconstriction	
pain: 10°C	35°C	thermogenesis
	25°C	hypothermia
		death

1.3 Factors of comfort

The variables that affect heat dissipation from the body (thus also thermal comfort) can be grouped into three sets:

<i>environmental</i>	<i>personal</i>	<i>contributing factors</i>
air temperature	metabolic rate (activity)	food and drink
air movement	clothing	acclimatization
humidity		body shape
radiation		subcutaneous fat
		age and gender
		state of health

Air temperature is the most important environmental factor, measured by the dry bulb temperature (DBT). This will determine the convective heat dissipation, together with any air movement. In the presence of air movement the surface resistance of the body (or clothing) is much reduced.

Air movement is measured by its velocity (v , in m/s) and it also affects the evaporation of moisture from the skin, thus the evaporative cooling effect.

Humidity of the air also affects evaporation rate. This can be expressed by relative humidity (RH, %), absolute humidity or moisture content (AH, g/kg), or vapour pressure (p , in kPa).

Radiation exchange will depend on the mean temperature of the surrounding surfaces (weighted by the solid angle subtended by each surface), referred to as the mean radiant temperature (MRT) or on the presence of strong monodirectional radiation, e.g. from the sun.

The mean radiant temperature cannot be measured directly, but it can be approximated by globe temperature measurements. The globe thermometer is a matt black copper sphere, usually of 150 mm diameter, with a thermometer located at its centre (Fig.2). Positioned in a room, after equilibrium is reached (in 10-15 minutes) the globe will respond to the net radiation to or from the surrounding surfaces. If radiation is received, then $GT > DBT$; $GT < DBT$ indicates that the surrounding surfaces are cooler than the air, radiation is emitted. In still air $MRT = GT$, but a correction for air movement of v velocity (in m/s) is possible (see section 2.3).

The personal factors include the *metabolic rate* (activity level) - as discussed above, which in turn may be influenced also by food and drink, and the state of *acclimatization*. Short-term physiological adjustment to changed conditions is achieved in 20 - 30 minutes, but there are also long-term, endocrine adjustments which may extend beyond six months, which constitute the acclimatization process.

Both the vasomotor and evaporative regulation mechanisms are subject to acclimatization. In hot climates - for example - the volume of blood circulating can be increased by up to 20%, to maintain a constant vasodilation. Sweat secretion rate also increases over a period of several weeks. It is believed that the forward section of the hypothalamus gland regulates these changes through a complex neuro-endocrine process (see section 3.1.3).

Body shape and subcutaneous fat are important factors. Heat production is proportionate to the body mass, but heat dissipation depends on the body surface. A thin person would have a greater surface-to-volume ratio than someone with a more rounded body shape, so a proportionately greater heat exchange with the environment. The more rounded person would prefer a lower temperature, partly because of the lower surface-to-volume ratio, but also because subcutaneous fat is a good insulator.

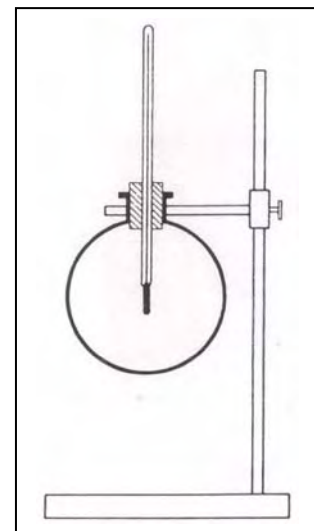

Fig.2 The globe thermometer

THERMAL COMFORT

Age and gender also affect thermal preferences: older people tend to have a narrower comfort range and women usually prefer a temperature 1 K higher than men (although some authors contend that this is due only to clothing differences).

Clothing is one of the dominant factors affecting heat dissipation. For the purposes of thermal comfort studies a unit has been devised, named the **clo**. This corresponds to an insulating cover over the whole body of a transmittance (U-value) of 6.45 W/m²K (i.e. a resistance of 0.155 m²K/W).

1 clo is the insulating value of a normal business suit, with cotton underwear. Shorts with short-sleeved shirts would be about 0.25 clo, heavy winter suit with overcoat around 2 clo and the heaviest arctic clothing 4.5 clo. Table 3 gives the clo-values of various pieces of garments. The total clo value of an ensemble is 0.82 times the sum of individual items.

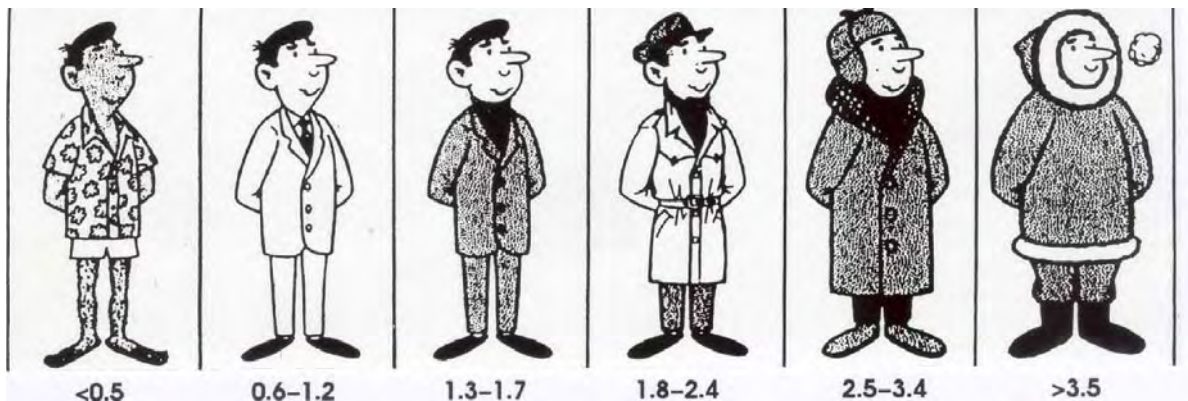

Fig.3 Insulation of clothing in clo units

TABLE 3 Insulating value of clothing elements

Man		clo	Women		clo	
underwear	singlets	0.06	underwear	bra + panties	0.05	
	T-shirt	0.09		half slip	0.13	
	briefs	0.05		full slip	0.19	
	long, upper	0.35		long, upper	0.35	
	long, lower	0.35		long, lower	0.35	
shirt	light, short sleeve	0.14	blouse	light	0.20	
	light, long sleeve	0.22		heavy	0.29	
	heavy, short sleeve	0.25		dress	light	0.22
	heavy, long sleeve	0.29			heavy	0.70
	+5% for tie or turtle-neck)					
vest:	light	0.15	skirt	light	0.10	
	heavy	0.29		heavy	0.22	
trousers	light	0.26	slacks	light	0.26	
	heavy	0.32		heavy	0.44	
pullover	light	0.20	pullover	light	0.17	
	heavy	0.37		heavy	0.37	
jacket	light	0.22	jacket	light	0.17	
	heavy	0.49		heavy	0.37	
socks	ankle length	0.04	stockings	any length	0.01	
	knee length	0.10		panty-hose	0.01	
footwear	sandals	0.02	footwear	sandals	0.02	
	shoes	0.04		shoes	0.04	
	boots	0.08		boots	0.08	

based on ASHRAE 1985

1.4 Basic psychrometry

The atmosphere is a mixture of air (oxygen and nitrogen) and water vapour. The science dealing with this mixture is *psychrometry* (from the Greek ψυχρος = psukhros = cold) and the graphic representation of various attributes of this mixture is the psychrometric chart. A full chart is shown on p.13 and the diagrams below illustrate a step-by-step build-up of this chart and some psychrometric processes.

- i) The horizontal axis is temperature, referred to as *dry bulb temperature* (DBT), measured in °C

(Note that °C, degree Celsius, is the notation referring to a point of the scale, but K, Kelvin is used to measure a temperature difference, or a length of the scale, without specifying where it is located on the scale. Thus 10°C + 30 K = 40°C)

and the vertical axis is moisture content or *absolute humidity* (AH), measured in g/kg, i.e. grams of moisture per kg of dry air (Fig.5-A). Some charts show this quantity in terms of a humidity ratio (HR), a non-dimensional quantity (kg/kg). Thus 12 g/kg would be shown as 0.012.

At any temperature the air can support only a given amount of water vapour and not more. The top curve of the chart shows the *saturation humidity* (SH). Other curves are produced by subdividing the ordinates (Fig.5-B).

- ii) *Vapour pressure* (pv) or - to be precise - the partial pressure of water vapour in the atmosphere is linearly related to absolute humidity, so the chart can show a vapour pressure scale alongside the AH scale, in units of kPa (kilo-Pascal). Similarly, the saturation humidity can be expressed as *saturation vapour pressure* (pvs).

This can be estimated (by the Antonine equation) as $pvs = 0.133322 \cdot \exp[18.6686 - 4030.183 / (DBT + 235)]$ which is the function to give the saturation curve (for a more accurate expression see p.38).

The relationship between vapour pressure and absolute humidity is $AH = 622 \cdot pv / (pt - pv)$ where pt is the total barometric pressure, taken as 101.325 kPa for a 'standard atmosphere'.

- iii) If this saturation line is taken as 100%, a series of curves can be produced by subdividing the ordinates corresponding to various percentages, referred to as *relative humidity* (RH) (Fig.5-B). $RH = (AH / SH) \cdot 100 (\%)$.

Some texts refer to this quantity as 'percentage saturation' and define relative humidity as $RH = (pv / pvs) \cdot 100 (\%)$

- iv) *Wet bulb temperature* (WBT) is measured by a hygrometer or psychrometer, which consists of two thermometers. One measures the DBT, the other has its bulb enclosed in a wick, which is kept moist. Good contact with the atmosphere is ensured either by whirling the instrument (whirling or sling hygrometer) or by a built-in small fan (aspirated hygrometer, Fig.7). This causes evaporation from the wick, cools the bulb and causes a 'wet bulb depression'. (Fig. 5-C). For the slope of this WBT line see note on p.12.

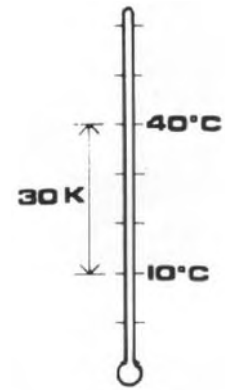

Fig.4 Temperature points and interval

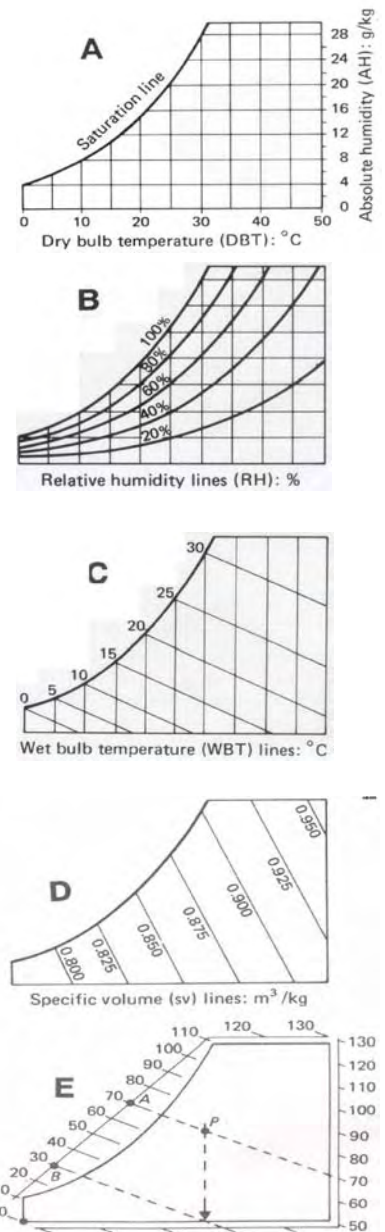

Fig.5 Structure of the chart:
 A the basic grid
 B relative humidity (RH %) curves
 C wet bulb temperature (WBT) lines
 D specific volume (sv) lines
 E enthalpy (H) lines

When the air is saturated, there is no evaporation, the DBT and WBT readings are identical (the two lines meet at the 100% curve). The evaporation, thus the cooling rate depend on the humidity of the air, thus from the two readings the humidity can be established. This will be indicated as the 'status point', at the intersection of the vertical DBT line and the sloping WBT line (Fig.5- C).

- v) The *specific volume* (*sv*) of the air-water mixture, measured in m³/kg, is the reciprocal of the density (kg/m³). It is indicated by another set of slightly sloping lines on the psychrometric chart. This is useful for the conversion of volumetric flow quantities into mass-flow rates, e.g. in air conditioning calculations (Fig.5 - D).
- vi) *Enthalpy* (*H*) is the heat content of unit mass of the atmosphere, in kJ/kg, relative to the heat content of 0°C dry air. It has two components: *sensible heat* (*HS*), which corresponds to temperature increase:

$$H = 1.005 \cdot T$$

where 1.005 kJ/kg is the specific heat capacity of dry air and latent heat (*HL*), which is the heat content due to the presence of water vapour in the air. It is the heat which was necessary to evaporate that amount of moisture (the latent heat of evaporation).

$$H = HS + HL$$

The enthalpy lines on the psychrometric chart would be very near to the WBT lines, therefore, to avoid confusion, the enthalpy scales are shown outside the body of the diagram.

The enthalpy for any status-point can be read by laying a straight-edge across the point, so that identical readings are obtained at both sides of the perimeter scale. The horizontal component is *HS* and the vertical component is *HL*, e.g. for air condition *P* (Fig.5 - E) :

$$H = 0 \rightarrow A = 70 \text{ kJ/kg}$$

of which

$$HS = 0 \rightarrow B = 30 \text{ kJ/kg}$$

and

$$HL = B \rightarrow A = 40 \text{ kJ/kg.}$$

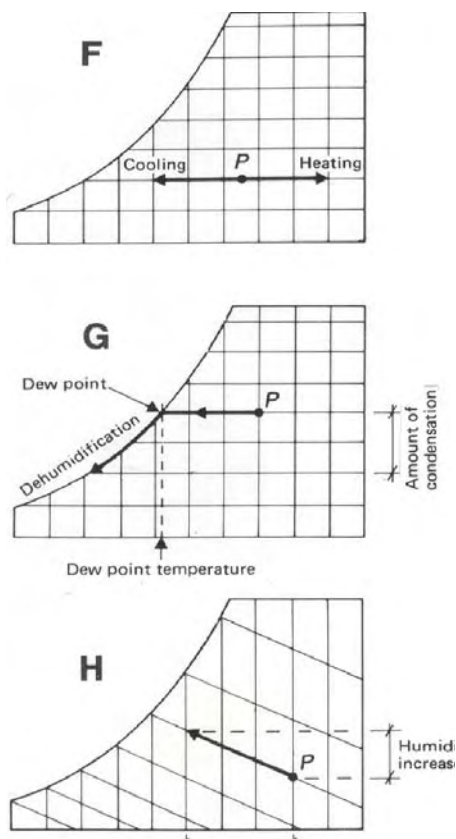

Fig.6 Psychrometric processes
 F cooling / heating
 G dehumidification
 H humidification (evaporative cooling)

- ii) Psychrometric processes can be traced on the chart. If *P* is the status point of a given volume of air, heating will move this point horizontally to the right, and cooling: to the left, horizontally, as there is no change in absolute humidity (Fig.6 - F).

- iii) In cooling, as the status point moving to the left reaches the saturation curve, condensation would start. The temperature at that point is referred to as the *dew-point temperature* (DPT) of the original (point *P*) atmosphere (Fig.6 - G).

When cooling continues, the status point will move down along the saturation curve. The corresponding vertical distance indicates the amount of condensation, as change in *AH*. This process is referred to as *dehumidification by cooling*.

- ix) Adiabatic humidification takes place if moisture is evaporated into an air volume without any heat input or removal (this is the meaning of the term 'adiabatic'). This is the process in evaporative cooling. The status point will move up towards the left along a constant WBT line (Fig.6 - H).

THERMAL COMFORT

Note: To be precise: it will move along a constant enthalpy line, but the two are practically the same:

$$\text{slope of enthalpy line: } \frac{\Delta AH}{\Delta DBT} = \frac{-1000}{2501 + 1.805 \cdot DBT}$$

the WBT line shows a negligible curvature:

$$\frac{\Delta AH}{\Delta DBT} = \frac{-1000}{2501 + 1.805 \cdot DBT - 4.186 \cdot WBT}$$

where AH is in g/kg
DBT and WBT in °C

The latent heat of evaporation is taken from the air, thus its temperature is decreased: the HS is decreased, but moisture is added: HL is increased. The process can be considered as the conversion of sensible heat into latent heat.

Any two of the above quantities known will locate the status point on the chart, and all other quantities can then be read. Usually the DBT and WBT are measured (by a hygrometer) and the others will be read from the chart.

Humidity of the atmosphere can thus be expressed at least six different ways:

- WBT wet bulb temperature
- DPT dew point temperature
- AH absolute humidity (moisture content)
- HR humidity ratio
- pv vapour pressure
- RH relative humidity (percentage saturation)

At the centre of the chart (Fig.8), at DBT 25°C and RH 50% a small circle marks a reference point, to be used in conjunction with the uppermost scale. This is often used in air conditioning calculations: locate the status point of outdoor air and project a line from the reference point through this status point (e.g. by a straight-edge) to the uppermost scale, which will give the sensible heat/total heat (HS/H) ratio.

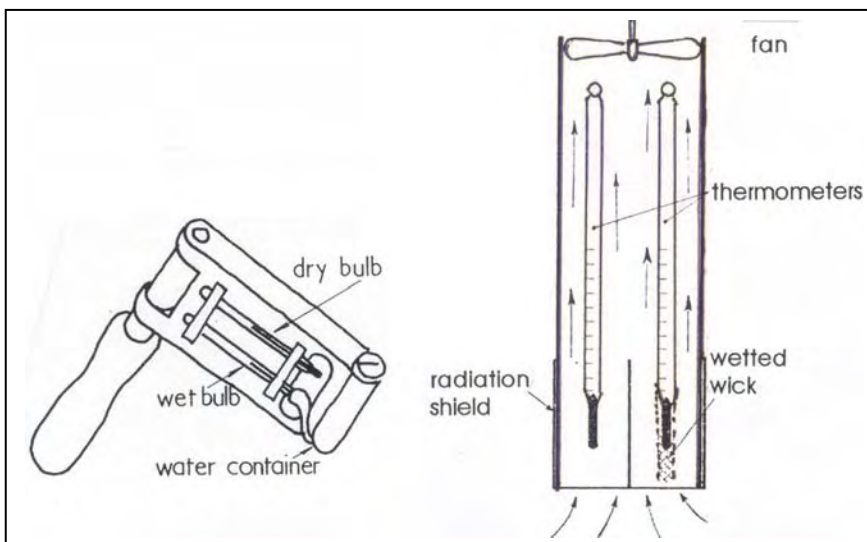

Fig.1.7 (a) The sling hygrometer

(b) the aspirated hygrometer

THERMAL COMFORT

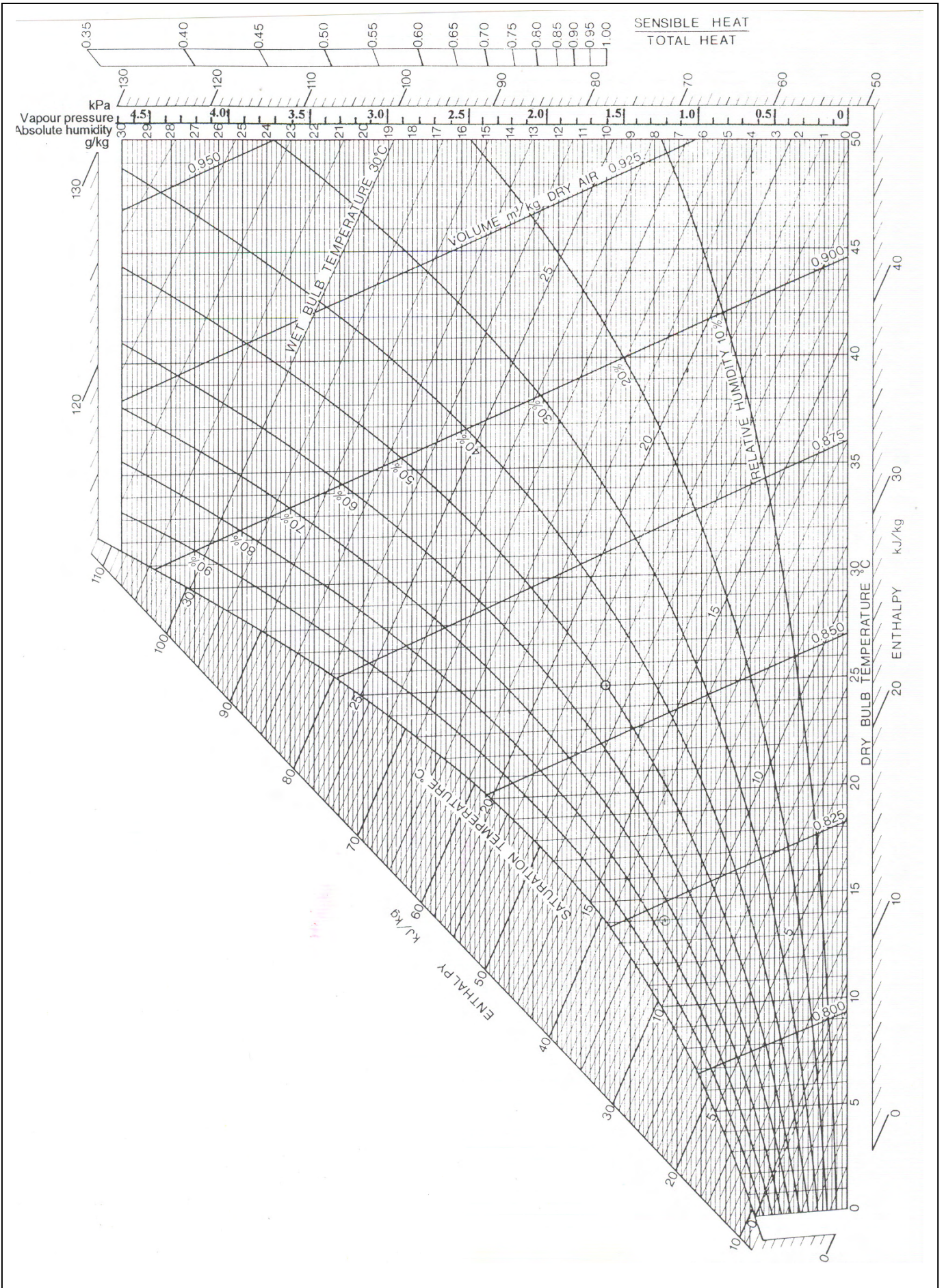

Fig.8 Psychrometric chart for barometric pressure of 101.325 kPa (= 1013.25 hPa or mbar)

after Szokolay, 1980

1.5 Air movement

The velocity of air movement is measured by anemometers of various types. The hand-held propeller type (Fig.9-a) is used for directional air flow, such as in ventilation or air conditioning systems. The cup type (Fig.9-b) is generally used where it is mast-mounted, in combination with a wind vane. These two types are rather unreliable for low air velocities (below 1 m/s). In wind tunnel studies the Pitot-tube anemometer (Fig.9-c) is most often used (this measures the difference between static and dynamic pressures, which is a function of air velocity). For very low velocity and random air movements the Kata thermometer was used in the past, but this has practically disappeared and the hot-wire anemometer took over. Both these are in fact measuring the cooling rate, which is proportionate to the air velocity.

It is common experience that air movement, be it a natural wind, or generated by a fan, has a cooling effect. This largely depends on the velocity of that air movement. Under everyday conditions the average subjective reactions to various velocities are:

< 0.25 m/s	unnoticed
0.25-0.50	pleasant
0.50-1.00	awareness of air movement
1.00-1.50	draughty
> 1.50	annoyingly draughty

These reactions however, depend on the temperature of the air. Under hot conditions 1 m/s is pleasant and indoor air velocities up to 1.5 m/s are acceptable. Above this, light objects may be blown about, thus indirect nuisance effects may be created. Under cold conditions, in a heated room 0.25 m/s velocity should not be exceeded, but even in a heated room stagnant air (velocities < 0.1 m/s) would be judged as "stuffy".

The effect of air movement is two-fold: the convection heat loss coefficient of the body (or clothing-) surface (h_c) is a function of air velocity, but evaporation from the skin, thus the evaporation heat loss coefficient (h_e) is also increased by moving air.

Heat dissipation from the body surface (the "physiological cooling effect") is a complex phenomenon: it also depends on the amount of clothing worn (clo), on activity level (met) and resulting skin temperature, on perspiration, i.e. skin wettedness (thus evaporation), but on air temperature (thus temperature difference) and on the humidity of the air (thus vapour pressure difference) as well. An additional effect is that with no movement a practically saturated air layer is formed at the body surface, which prevents (reduces) further evaporation. Air movement would remove this saturated air envelope.

As a rough guide, for persons at sedentary activity (1.2 met) and wearing light clothing (0.5 clo) the ASHRAE Handbook of Fundamentals permits extension of the upper comfort limits by 1 K for every 0.275 m/s air velocity (above 0.2 m/s and up to 0.8 m/s, thus by a maximum of only 2 K). Givoni (1994) suggests that for warm climates this should be extended to 2 m/s (i.e. by 6 K). Most sources take the limit as 1.5 m/s for non-thermal reasons.

A general guide is given by the numerical approximation for such cooling effect (thus extension of comfort limits):

$$dT = 6 \bullet (v-0.2) - 1.6 \bullet (v-0.2)^2 \quad (\text{up to } v = 2 \text{ m/s}) \quad \dots 1.2)$$

or if effective velocity is denoted $v_e = v - 0.2$ then

$$dT = 6 \bullet v_e - 1.6 \bullet v_e^2$$

Another study gave the correlation equation

$$dT = -1.2844 v^2 + 5.9331 v - 1.0136$$

and for the usual range of 0.2 to 1.5 m/s a reasonable estimate is given by

$$dT = 3.2 v$$

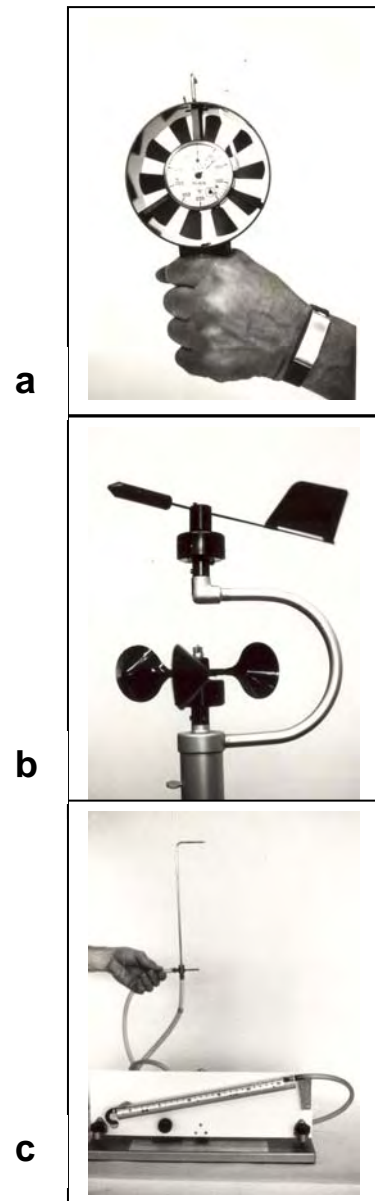

Fig.9 Three anemometers:
 a: propeller type
 b: cup-type
 c: Pitot tube with manometer

PART 2 STUDIES AND INDICES

2.1 Laboratory tests and field studies

There are essentially two methods available for ascertaining people's thermal comfort:

1. by questionnaires, with simultaneous measurement of conditions, used mostly in spaces normally occupied by the respondents, i.e. in field studies (although questionnaires can also be used in laboratory studies)
2. by measurements of physiological changes, such as sweating, skin wettedness or skin temperature, which would normally be carried out in laboratories (controlled environment rooms or 'climate chambers').

Most researchers use a seven-point scale, either that developed by Bedford, or the ASHRAE scale. The two are compared in Table 4.

TABLE 4 Comparison of verbal 'comfort scales'

	ASHRAE	Bedford
3	hot	much too warm
2	warm	too warm
1	slightly warm	comfortably warm
0	neutral	comfortable
-1	slightly cool	comfortably cool
-2	cool	too cool
-3	cold	much too cool

Note that the original ASHRAE scale used numbers from 1 to 7, where 1 meant cold and 7 meant hot, but the above, symmetrical about comfort is used in most studies. The 'graphic scale' used by Woolard in a Solomon Islands study, shown below, used the 1 to 7 scale.

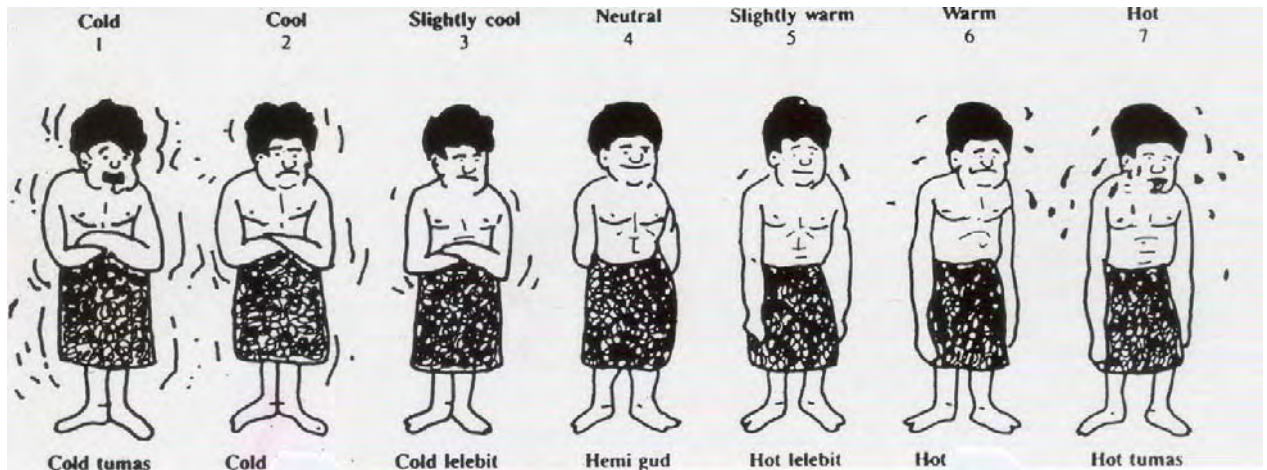

Fig.10 A graphic comfort scale

In Table 4 the difference in semantics is important. Temperature sensation is at the *discriminatory* level, but how the integrated thermal signals affect comfort is at the *affective* level. The Bedford scale is probably related to this level. The ASHRAE scale implies *cognitive* judgement, which is indicative of *satisfaction*. Past experience and socio-cultural factors may influence the *effective thermal preference* of people. Reviewing the state of the art Auliciems (1981) proposed a psycho-physiological model of thermal comfort, which is also the basis of his *adaptation hypothesis* (see sections 2.6 and 3.1.2, and Fig. 27).

THERMAL COMFORT

The ASHRAE definition of *comfort* is "the condition of mind that expresses satisfaction with the thermal environment; it requires subjective evaluation". This clearly embraces factors beyond the physical/physiological.

It is interesting how different environmental conditions are interpreted and what adjectives are used to describe them. Olgyay (1953) in his *bioclimatic chart* (see section 4.1) used terms such as

keen for cool, dry,
raw for cool-humid
sultry for warm-humid.

Cool-humid conditions are often referred to as *dank* and hot-dry as *torrid* or *scorching*. Interestingly, warm-humid conditions attract the largest number of adjectives, such as *muggy*, *sticky*, *stifling*, *seething* or just *close*.

It has been found that concepts such as *freshness* relate to transient conditions. Its opposite: *stuffiness* seems to relate to lack of change and air movement, but perhaps also to humidity. A too steady and constant environment may be judged as *soporific*, whilst larger and more frequent transients are *invigorating* or *stimulating*.

The conclusion must be that physiological neutrality (thermal equilibrium or, in terms of eq. 1.1: $\Delta S = 0$) does not necessarily mean *comfort*, a series of other factors are involved, such as past experience, socio-cultural factors, habits and expectations. However, the thermo-physiological mechanisms form the basis; physiological neutrality may be a pre-condition of comfort, therefore it will be examined in some detail in the following sections.

2.2 Heat exchange processes of the body

The generalised thermal balance model given in section 1.2 above, as eq.(1.1), was first proposed by Gagge (1936). Conduction being normally negligible, this can be re-written as

$$M \pm R \pm C - E = \Delta S \quad \dots 2.1)$$

Since then this went through many refinements and modifications. Today two versions are in general use:

- 1 the "two-node model" of the J B Pierce Laboratories (New Haven)
- 2 Fanger's "comfort equation".

In both cases the relationships are defined *a priori*, (on the basis of physical principles) and the various constants and coefficients are determined by measurements. Both will be examined in detail in the following two sections.

2.2.1 The two-node model

This treats first the heat transfer from the body core to the skin, then from the skin to the environment (for references see p.36, footnotes).

The body's metabolic rate is M (in watts). Some of this is converted to work, (to be precise: mechanical power).

The mechanical efficiency is $\eta = \text{work}/M$
The remainder is the body's heat production: $M(1-\eta)$
This can be expressed for unit body surface area: $M(1-\eta) / A_D$ in W/m^2
where A_D is the DuBois area

THERMAL COMFORT

The evaporation heat loss (E) has three components:

- E_{diff} = due to vapour diffusion through the skin
- E_{rsw} = due to evaporation of regulatory sweating from the skin
- E_{resp} = respiration latent heat loss

These components can be estimated in the following way:

$$E_{resp} = 0.0173 M (5.87 - p_a)$$

where 5.87 kPa: the saturation vapour pressure at lung temperature: 35°C

$$p_a = \text{vapour pressure of ambient air}$$

The sensible heat loss is:

$$C_{resp} = 0.0014 M (34 - t_a)$$

where 34°C is the exhaled air temperature

$$t_a = \text{ambient air temperature (DBT)}$$

These two quantities do not reach the skin surface, therefore the heat that reaches the skin is

$$M_{sk} = M (1 - \eta) - 0.0173 M (5.87 - p_a) - 0.0014 M (34 - t_a) \quad \dots 2.2$$

In the following analysis several heat transfer coefficients (conductances) are used (all in W/m²K, except the last one: h_e , which is W/m²kPa)

- h_r = radiation conductance (from surface to MRT)
- h_c = convection conductance (from surface to air)
- h = $h_r + h_c$
- h_{cl} = clothing conductance
- h_e = evaporation heat loss coefficient

The maximum possible evaporative heat loss from the body surface is

$$E_{max} = 16.7 h_c (p_{sk} - p_a) F_{pcl} \quad \dots 2.3$$

where p_{sk} = saturation vapour pressure at mean skin temperature

p_a = vapour pressure of ambient air (kPa)

16.7 is the *Lewis relation*, in K/kPa, the ratio of evaporative and convective heat transfer coefficients (h_e/h_c) at sea level

$$\left(\frac{W / m^2 kPa}{W / m^2 K} = \frac{K}{kPa} \right)$$

(the product 16.7 $h_c F_{pcl}$ is the effective evaporative heat transfer coefficient from skin surface to the environment)

F_{pcl} = vapour permeation efficiency from skin through clothing (non-dimensional)

then

$$E_{rsw} = W_{rsw} E_{max}$$

where $W_{rsw} = A_{sw}/A_D$ the "skin wettedness", the area of body surface exposed covered by a film of sweat (A_{sw}) as a fraction of the DuBois area.

From the area covered by clothing the sweat will evaporate by diffusion:

$$E_{diff} = (1 - W_{rsw}) 0.06 E_{max}$$

but in the absence of regulatory sweating, if $E_{rsw} = 0$

$$E_{diff} = 0.06 E_{max}$$

Generally, for resting subjects, if 40% < RH < 60% and DBT < 20°C

$E_{resp} + E_{diff}$ is about 20-25% of the metabolic rate.

The total skin evaporation, adding the above two terms, is:

$$E_{sk} = E_{diff} + E_{rsw} = (0.06 + 0.94 W_{rsw}) E_{max}$$

or substituting the E_{max} expression (eq.2.3):

$$E_{sk} = 16.7 (0.06 + 0.94 W_{rsw}) h_c (p_{sk} - p_a) F_{pcl} \quad \dots 2.4$$

THERMAL COMFORT

The ratio E_{sk} / E_{max} is w , the average wettedness of the skin.

When E_{sk} is taken as the evaporation heat loss necessary to maintain thermal equilibrium of the body, then the ratio $(E_{sk}/E_{max}) \cdot 100$ has been used as an index of heat stress (Belding & Hatch, 1956, see p.32).

The sensible heat loss from the body surface is

$$R+C = h (t_{sk}-t_a) F_{cl} \quad \dots 2.5$$

where F_{cl} = insulation value of clothing = $1/(1+0.155 h I_{cl})$,
 I_{cl} in clo units

(some sources distinguish F_{cl} and F_{cle} , effective insulation value, i.e. corrected by an F_{cl} term, as the outer area of clothing is greater than the body surface area. This is however negligible compared to the precision of the clo estimate)

So substituting eqs. 2.2, 2.4 and 2.5 into eq.2.1, the complete thermal balance equation can be written as

$$\Delta S = M [(1-\eta) - 0.0173 (5.87-p_a) - 0.0014 (34 - t_a)] - 16.7 (0.06+0.94 w_{rsw}) h_c (p_{sk}-p_a) F_{pcl} - h (t_{sk}-t_a) F_{cl} \quad \dots 2.6$$

CORE

The metabolic rate is M .

The mechanical efficiency of the body is η , thus $M \cdot \eta$ is work and $M \cdot (1-\eta)$ is the heat generated in the core.

Respiration removes some of this, partly as sensible heat (C_{resp}) partly as evaporative loss (E_{resp}).

$C_{resp} = 0.0014 M (34-t_a)$ and
 $E_{resp} = 0.0173 M (5.87-p_a)$

where 34°C is the exhaled air temperature
 and 5.87 kPa is vapour pressure at lung temperature of 35°C

The remainder is transported to the skin:
 $M_{sk} = M \cdot (1-\eta) - C_{resp} - E_{resp}$ (see eq.2.2)

SKIN

This M_{sk} is dissipated from the skin as sensible heat by radiation R and convection C and as latent heat (evaporative loss)

Sensible: $R + C$ is given by eq.2.5 above

Latent: evaporative loss has two components: diffusion and regulatory sweating

$E_{sk} = E_{diff} + E_{rsw}$

if w_{rsw} is skin wettedness, then

$E_{rsw} = w_{rsw} E_{max}$ and
 $E_{diff} = (1 - w_{rsw}) 0.06 E_{max}$

thus $E_{sk} = (0.06 + 0.94 w_{rsw}) E_{max}$

both are expressed in terms of the maximum evaporation potential of the body: E_{max} , as shown above and

if the E_{max} expression is substituted we get eq.2.4

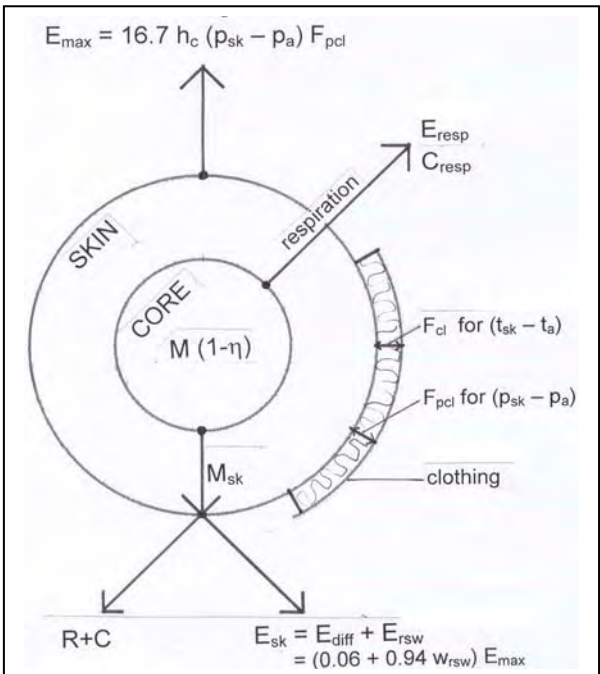

Fig.11 Summary of the "two-node model"

for a numerical example see Appendix 1

$$F_{cl} = \frac{1}{1 + 0.155 \cdot h \cdot clo}$$

$$F_{pcl} = \frac{1}{1 + 0.344 \cdot h_c \cdot clo}$$

normally $h = 8 \text{ W/m}^2\text{K}$
 $h_c = 3.3$

THERMAL COMFORT

2.2.2 Fanger's heat balance ('comfort-') equation

(It is unfortunate that even the 1982 edition of Fanger's work uses obsolete metric units, but his comfort equation is still presented, to illustrate his method.)

Although the author (Fanger 1970/1982) refers to this as "comfort equation", it is actually a heat balance equation, arranged to give a zero storage component, which will be related to comfort through the PMV method (see section 2.5.7).

He uses the term H for $M(1-\eta)$ i.e. the body's net heat production and as he considers thermal comfort, a condition of which is that the storage component, ΔS , is zero (apart from short term transient effects), and as conduction loss (C_d) is normally insignificant, for the equilibrium condition eq.1.1 can be written as

$$H - E - C - R = 0$$

Refining this, he writes his "double equation" as

$$H - E_{diff} - E_{rsw} - E_{resp} - L = K = R + C \quad \dots 2.7)$$

where L = dry respiration loss all terms in kcal/h
 K = heat transfer from skin to clothing surface
 R = radiation loss
 C = convection loss

The components of this are calculated as follows:

$$E_{diff} = \lambda m A_D (p_s - p_a)$$

where λ = latent heat of evaporation of water (575 kcal/kg)
 m = permeance of skin ($6.1 \cdot 10^{-4}$ kg/h m^2 mmHg)
 p_s = saturation vapour pressure at skin temperature (mmHg)
 p_a = vapour pressure of ambient air (mmHg)

substituting the appropriate numerical values

and as $p_s = 1.92 t_s - 25.3$ we get

$$E_{diff} = 0.35 A_D (1.92 t_s - 25.3 - p_a)$$

It has been shown that the skin temperature for comfort conditions is

$$t_s = 35.7 - 0.032 H/A_D$$

substituting:

$$E_{diff} = 0.35 A_D [43 - 0.061 (M/A_D)(1-\eta) - p_a] \quad \dots 2.8)$$

For comfort conditions E_{rsw} must be within very narrow limits and it has been shown that for average situations

$$E_{rsw} = 0.42 A_D [(H/A_D) - 50] \quad (50 \text{ kcal/h.mm}^2 = 1 \text{ met}) \quad \dots 2.9)$$

The respiration latent heat loss is calculated as

$$E_{resp} = V (HR_{ex} - HR_{in}) \lambda$$

where V = pulmonary ventilation rate, found as $0.006 M$ (kg/h)
 HR = humidity ratio of air as exhaled and inhaled
 λ = latent heat of evaporation of water (575 kcal/kg)

Substituting humidity ratios and vapour pressures we get

$$E_{resp} = 0.0023 M (44 - p_a) \quad (\text{kcal/h}) \quad \dots 2.10)$$

The dry respiration loss is calculated as

$$L = 0.0014 M (34 - t_a) \quad (\text{kcal/h}) \quad \dots 2.11)$$

THERMAL COMFORT

When these three terms are subtracted from H, the remainder must be dissipated by conduction through the clothing (K) and subsequently by radiation and convection (R+C) from the surface of clothing.

$$K = A_D (t_s - t_{cl}) / 0.18 I_{cl}$$

where I_{cl} = insulation of clothing in clo units
 t_s = skin temperature
 t_{cl} = clothing surface temperature

and substituting the above expression for t_s :

$$K = A_D [(35.7 - 0.032 H/A_D) - t_{cl}] / 0.18 I_{cl} \quad \dots 2.12)$$

The radiation component is

$$R = A_{eff} \epsilon \sigma [(t_{cl} + 273)^4 - (t_r + 273)^4]$$

where ϵ = emittance of outer surface of clothing
 σ = the Stefan-Boltzmann constant
 t_{cl} = temperature of outer surface of clothing
 t_r = mean radiant temperature

After substituting of the appropriate numerical values we get

$$R = 3.4 \cdot 10^{-8} A_D f_{cl} [(t_{cl} + 273)^4 - (t_r + 273)^4] \quad \dots 2.13)$$

where f_{cl} = ratio of clothed to exposed body surface

The convection component is

$$C = A_D f_{cl} h_c (t_{cl} - t_a) \quad \dots 2.14)$$

where h_c = convection conductance (kcal/m²h°C)

The magnitude of h_c (here in kcal/m²h.K) depends on air velocity (m/s):

but in W/m²K

the criterion (crit) is $2.05 (t_{cl} - t_a)^{0.25}$ $1.762(t_{cl} - t_a)^{0.25}$

if crit > $10.4 \sqrt{v}$ then $h_c = \text{crit}$

if crit < $10.4 \sqrt{v}$ then $h_c = 10.4 \sqrt{v}$ $8.9 \sqrt{v}$

Substituting the above eqs. 2.8, .9, 10 and 11 into the "double equation" 2.7, as well as 2.12, 13 and 14, writing $M(1-\eta)$ for H, and dividing each term by A_D the full comfort equation becomes

$$\begin{aligned} & \frac{M}{A_D} (1-\eta) - 0.35 \left[43 - 0.061 \frac{M}{A_D} (1-\eta) - p_a \right] - 0.42 \left[\frac{M}{A_D} (1-\eta) - 50 \right] - \\ & - 0.0023 \frac{M}{A_D} (44 - p_a) - 0.0014 \frac{M}{A_D} (34 - t_a) = \frac{35.7 - 0.032 \frac{M}{A_D} (1-\eta) - t_{cl}}{0.18 I_{cl}} = \end{aligned}$$

$$3.4 \cdot 10^{-8} f_{cl} [(t_{cl} + 273)^4 - (t_r + 273)^4] + f_{cl} h_c (t_{cl} - t_a) \quad \dots 2.15)$$

This is the basis of his PMV index, which is described in section 2.5.7.

THERMAL COMFORT

2.3 Physical measures

Simple	DBT	dry bulb (air) temperature
	WBT	wet bulb temperature
	GT	globe temperature (measured with a black copper globe of 100 or 150 mm diameter or the 40 mm black 'ping-pong ball' globe)
Composite	MRT	mean radiant temperature
	DRT	dry resultant temperature
	EnvT	environmental temperature

MRT this is the solid-angle-weighted average temperature of surrounding surfaces. It cannot be measured directly, but it can be estimated from GT readings. In still air $MRT = GT$, but a correction for air movement of v velocity (in m/s) is possible:

$$MRT = GT \cdot (1 + 2.35\sqrt{v}) - 2.35 \cdot DBT \cdot \sqrt{v}$$

The following expressions are claimed to be more accurate:

$$(MRT + 273)^4 = (GT + 273)^4 + 247 \cdot 10^6 \sqrt{v} (GT - DBT)$$

$$MRT + 273 = \left[(GT + 253)^4 + \frac{1.1 \cdot 10^8 v^{0.6}}{\varepsilon \cdot d^{0.4}} (GT - DBT) \right]^{0.25}$$

where ε = emittance and d = diameter of globe thermometer

DRT this is the average of MRT and DBT: $DRT = \frac{1}{2}MRT + \frac{1}{2}DBT$

(simplified from $\frac{MRT + DBT \sqrt{10v}}{1 + \sqrt{10v}}$ when $v \leq 0.1$ m/s)

EnvT this is also a composite of MRT and DBT, used in describing the heat exchange between the "environmental point" in a room and the internal surfaces:

$$EnvT = \frac{2}{3}MRT + \frac{1}{3}DBT \quad (\text{Danter, 1974, CIBSE, 1978})$$

Beyond the above simple and composite physical measures a whole series of thermal comfort indices have been developed. Two main types of these can be distinguished: empirical measures, those that were produced by questionnaire studies, under defined environmental conditions and those produced by analytical methods, tracing the flow paths from metabolic heat production to the environment and considering resistances to such flows. The following pages will describe in detail the most important such measures: nine empirical and eleven analytical indices. Most are applicable primarily to indoor conditions, but there are two simple indices designed for outdoor use:

WCI Wind chill index: used in cold climates to ascertain the cooling effects of wind:

$$WCI = (12.15 + 11.6\sqrt{v} - v) \cdot (33 - DBT) \quad \text{where } v \text{ is in m/s}$$

then the wind chill temperature is

$$WCT = 33 - 0.03738 \cdot WCI$$

THI* Temperature-humidity index: (intended for use in warm-humid climates)

$$THI = 0.72 \cdot (DBT + DPT) + 0.46 \quad \text{in } ^\circ\text{F}, \quad \text{but in } ^\circ\text{C:}$$

$$THI = 0.55 \cdot DBT + 0.2 \cdot DPT + 5.3 \quad \approx 0.8 \cdot DBT = \frac{RH \cdot DBT}{500}$$

interpretation: a value of 21(°C) is OK, 24 means discomfort for 50% of people; 26 indicates discomfort for all and at 29 work should be suspended.

* US Weather Bureau (1959): Notes on temperature-humidity index LS5922, Washington

THERMAL COMFORT

2.4 Measures of comfort: empirical indices

2.4.1 Effective temperature (ET)

Developed by Houghten and Yagloglou at the ASHVE Pittsburgh research laboratories in 1923: represented by a set of *equal comfort lines* drawn on the psychrometric chart. It is defined as the temperature of a still, saturated atmosphere, which would, in the absence of radiation, produce the same effect as the atmosphere in question. It thus combines the effect of dry air temperature and humidity. It became the most widely used index for the next 50 years, but it is now superseded.

It has been defined as: $ET = DBT - 0.4 * (DBT - 10) * \left(1 - \frac{RH}{100}\right)$ in °C

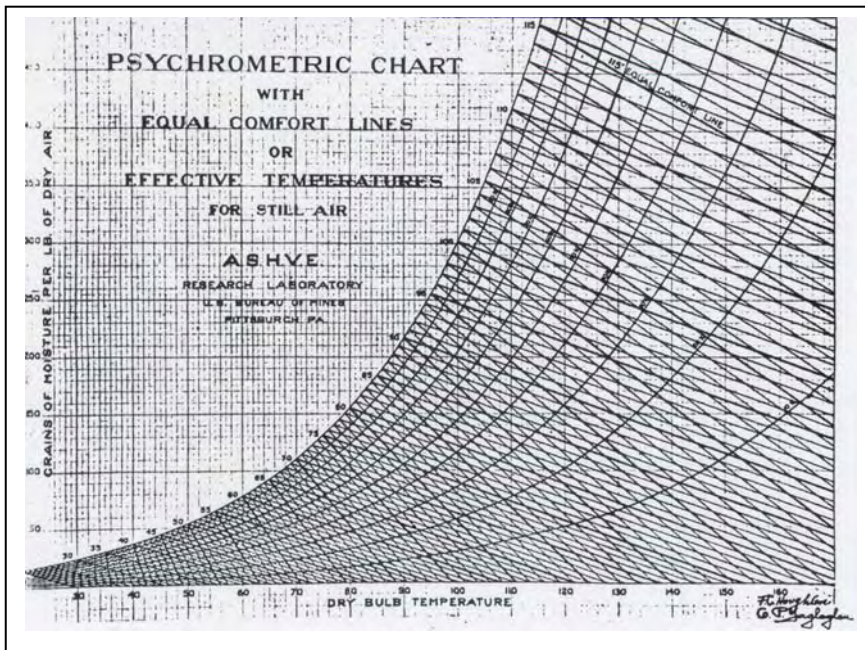

Fig.12 Yagloglou's original representation of the effective temperature

Yaglou in 1947 (who shortened his name by then) already noted that the ET overestimates the effect of humidity, especially at lower temperatures. Smith (1955) found that the relationship is not linear and that the P4SR index gives a better correlation with comfort votes.

Glickman et al. (1950) also found that ET overestimates the effect of humidity under both cool and comfortable conditions.

-
- Glickman, N, Inouye, T, Keeton, R W and Fahnestock, M K (1950): Physiological examination of the effective temperature index, *ASHVE Trans.* 56:51
Houghten, F C & Yagloglou, C P (1923): Determination of comfort zone. *Trans Am Soc Heat Vent Engrs.* 29:361
Houghten, F C & Yagloglou, C P (1923/a): Determining equal comfort lines. *J Am Soc Heat Vent Engrs.* 29:165
Yaglou, C P (1947): A method for improving the effective temperature index. *Trans ASHVE,* 53:307
Yagloglou, C P (1927): The comfort zone for men. *J of Industrial Hygiene.* 9:251

THERMAL COMFORT

2.4.2 Corrected effective temperature (CET)

ASHVE (1932) published a nomogram representation of the ET index, which included air velocity effects and showed that over about 100°F (37.8°C) and 100% RH, air movement increases the thermal load (hence the reversal of the air velocity lines). Vernon (1932) included the effect of radiation by substituting globe temperature values for the dry bulb temperature scale, adopted also by Bedford (1940). This became known as the CET nomogram. As clothing has a large influence on radiation and wind effects, he produced two nomograms: for people wearing 1 clo clothing (normal scale) and for people stripped to the waist (basic scale):

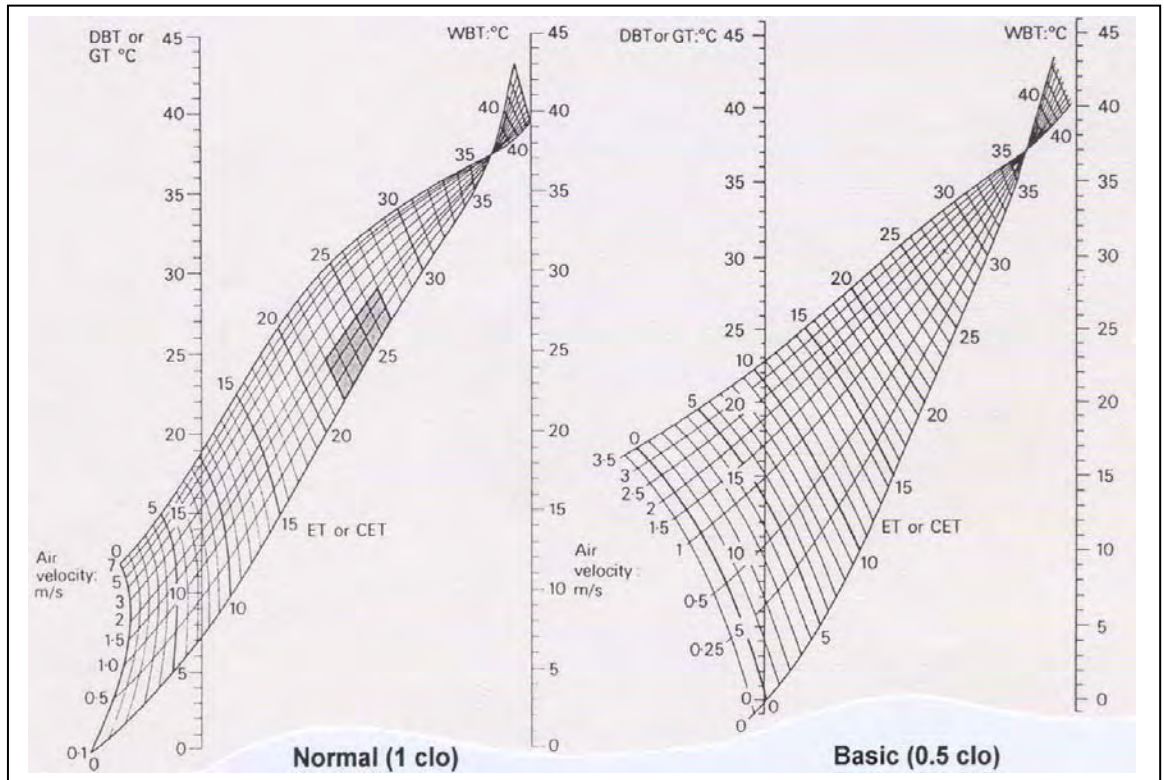

Fig.13 CET nomograms for people wearing 1 clo and stripped to the waist

The following expressions approximate the values at 0.1 m/s air speed:

normal:
$$CET = (1.21 GT - 0.21 WBT) / [1 + 0.029(GT - WBT)]$$

basic:
$$CET = (0.944 GT - 0.056 WBT) / [1 + 0.022(GT - WBT)]$$

Smith (1955) found that in hot environments the effect of humidity is underestimated and that the adverse effect of 0.5 - 1.5 m/s air velocities at high temperatures is overestimated. Givoni (1963) however established that above 32°C air movements produced a greater heating effect than that suggested by the ET.

Bedford, T (1936): *Warmth factor in comfort at work*. Med Res Council, Industr Health Res Board, Report No 76. HMSO

Bedford, T (1940): *Environmental warmth and its measurement*. Med Res Council, War Memorandum No 17. HMSO

Givoni, B (1963): *Estimation of the effect of climate on man*. Research Report to UNESCO. BRS Technion, Haifa

Vernon, H M (1932): The measurement of radiant heat in relation to human comfort. *J.Industrial Hygiene*, 14:95-111

ASHVE (1932): *Guide*. Am Soc Heat Vent Engrs

THERMAL COMFORT

2.4.3 Wet bulb globe temperature (WBGT)

The WBGT has been developed by Yaglou and Minard (1957) for a simple field measurement of the old ET, for the control of heat casualties in US military training centres. It indicates the combined effect of air temperature, low temperature radiant heat, solar radiation and air movement.

It is the weighted average of DBT, naturally ventilated WBT and globe temperature, for outdoor use (including the presence of solar radiation). For indoor use the DBT term is dropped out.

for indoors: $WBGT = 0.7 \cdot WBT + 0.3 \cdot GT$
 for outdoors: $WBGT = 0.7 \cdot WBT + 0.2 \cdot GT + 0.1 \cdot DBT$
 (using naturally ventilated WBT)

The relation between WBGT and permissible heat exposure limits is shown by the following graph (numbers alongside the curves are in °F):

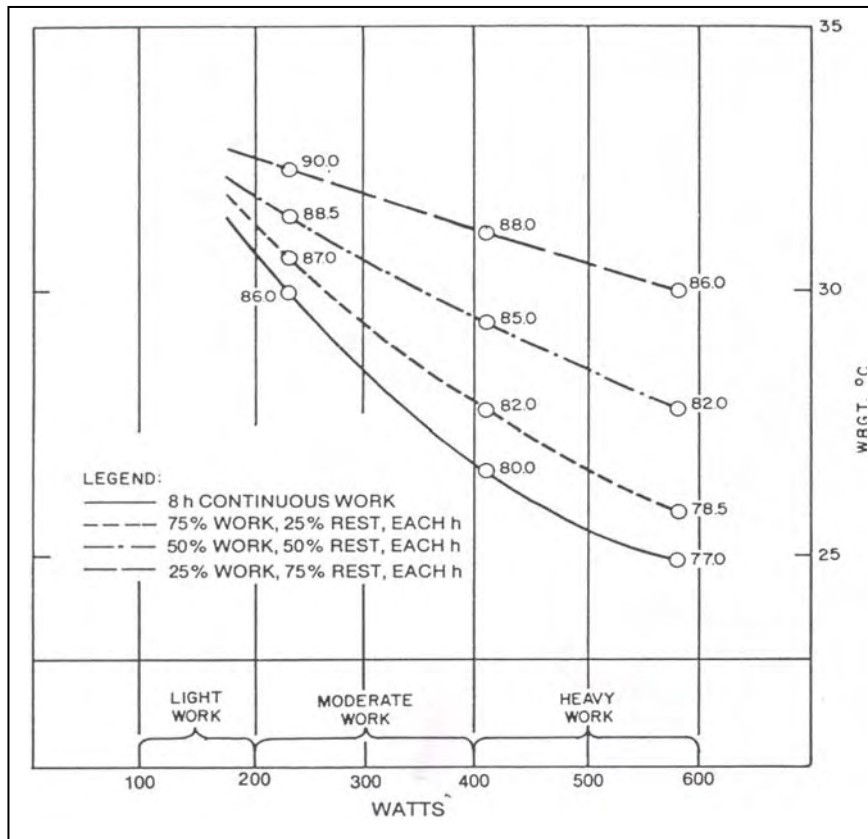

Fig.14 Permissible heat exposure limits predicted by the WBGT index

Yaglou, C P & Minard, D (1957): Control of heat casualties at military centers. *AMA Archives of Industrial Health*, 16: 302

Dukes-Dobos, F & Henschel, A (1971): *The modification of the WBGT index for establishing permissible heat exposure limits in occupational work*. HEW, USPHS, ROSH, TR-69

THERMAL COMFORT

2.4.4 Operative temperature (OT)

This index was produced by Winslow, Herrington & Gagge, as a result of work similar to Bedford's. It is defined as the temperature of a uniform, isothermal "black" enclosure in which man would exchange heat by radiation and convection at the same rate as in the given non-uniform environment; or as the average of MRT and DBT weighted by their respective transfer coefficients, i.e. the following expression:

$$OT = \frac{h_r MRT + h_c DBT}{h_r + h_c}$$

where h_r and h_c are radiation and convection coefficients

This index integrates the effect of air temperature and radiation, but ignores humidity and air movement. The study was carried out under cool conditions, where the effect of humidity was small and indoor air movement negligible.

There is a subsequent correction for air movement:

$$OT = \frac{h_r MRT + h_c \left[DBT \sqrt{\frac{v}{v_o}} - t_{sk} \left(\sqrt{\frac{v}{v_o}} - 1 \right) \right]}{h_r + h_c}$$

where v air velocity (ft/min or m/s)
 v_o reference velocity (15 ft/min \approx 0.076 m/s)
 t_{sk} skin temperature
 h_c convection conductance, taken
 at $v_o = 8.3 \times 0.076^{0.6} = 1.77$
 h_r 4.7

(such corrections for air velocity are by no means generally accepted)

If MRT = DBT and air movement is negligible, then OT = DBT

ASHRAE now suggests that a simple averaging gives acceptable results:

$$OT = \frac{MRT + DBT}{2}$$

An alternative definition from the heat balance equation is:

$$R + C = h \cdot (OT - T_{surfaces}) = h \cdot (OT - t_{sk}) \cdot F_{cl}$$

where $h = h_r + h_c$ (radiative + convective surface coefficient)
 and the thermal efficiency of clothing is

$$F_{cl} = \frac{1}{1 + 0.155 f_{cl} h \cdot I_{cl}}$$

where I_{cl} is in clo units

and the clothing factor is the ratio of clothed body surface to the DuBois body area:

$$f_{cl} = A_{cl} / A_D$$

The index is thought to be unsuitable above 27°C as it does not consider evaporative heat dissipation (Givoni, 1962)

Winslow, C E A, Herrington, L P & Gagge, A P (1937): Physiological reactions to environmental temperature. *Am J of Physiology*, 120:1-22
 Givoni, B (1962): *The nature and application of thermal indices*. Bulletin No 73-74. Israel Inst. of Technology

THERMAL COMFORT

2.4.5 Equivalent temperature (EqT)

This scale has been introduced by Dufton (1932 & 1933) and its use is described by Bedford (1951). Its conceptual definition is: the temperature of a uniform enclosure, with still air, in which a sizeable black body at 24°C (75°F) would lose heat at the same rate as that observed. By regression analysis Bedford produced the following equation: (quoted in original units):

$$\text{EqT} = 0.522\text{DBT} + 0.478\text{MRT} - 0.0147 \cdot \sqrt{v} \cdot (100 - \text{DBT})$$

where DBT = air temperature (°F)
MRT = mean radiant temperature (°F)
v = air velocity (ft/min)

or

$$\text{EqT} = 0.522\text{DBT} + 0.478\text{GT} + \sqrt{v} \cdot (0.0808\text{GT} - 0.0661\text{DBT} - 1.474)$$

where GT = globe temperature (°F)

or in SI units:

$$\text{EqT} = 0.522\text{DBT} + 0.478\text{MRT} - 0.21 \cdot \sqrt{v} \cdot (37.8 - \text{DBT})$$

Bedford (1936) devised a nomogram for determining the EqT from measured individual thermal factors.

This index does not take into account humidity, thus it is unsuitable for temperatures higher than about 24°C, as at such levels humidity becomes increasingly important.

Bedford, T (1951): Equivalent temperature, what it is, how it's measured. *Heating, Piping, Air conditioning*. Aug. p.87-91

Dufton, A F (1932): *Equivalent temperature and its measurement*, B R Technical Paper 13. HMSO

Dufton, A F (1933): The use of kata thermometers for the measurement of equivalent temperature. *J Hygiene, Camb.* 33:349

2.4.6 Equivalent warmth (EqW)

This index was developed by Bedford, modifying the above, based on experiments with over 2000 factory workers, engaged in light work, under varying indoor conditions. Air temperature, humidity and mean radiant temperature were measured and recorded and correlated with subjective responses of the subjects.

Clothing and skin temperatures were also recorded. This correlation produced the EqW scale. Its definition is 'the temperature of a uniform environment with DBT = MRT, still air and 50% RH, which produces the same feeling of warmth as the actual environment' - almost the same as that of the modern ET*

It is now thought to be reliable within the comfort range and up to 35°C with low RH or up to 30°C with high RH. It underestimates the cooling effect of air movement with high humidities and it does not consider clothing or activity levels.

Bedford, T (1936): *Warmth factor in comfort at work*, Med Res Council, Industrial Health Research Board, Report No. 76

THERMAL COMFORT

2.4.7 Resultant temperature (RT)

This index was developed by Missénard in France. It is based on measurements and votes in a test room, after 0.5 hour of adjustment (as opposed to the ET scale, also based on test room measurements, but on instantaneous reactions).

It is a slight improvement on the ET scale, but only for rest or low activity conditions. The nomogram defining it is similar to the ET nomogram. It is thought to be reliable for moderate climates, but not for tropical conditions, as it underestimates the cooling effect of air movements at temperatures above 35°C and over RH 80%, while at lower values of the RT the effect of air movement is overestimated.

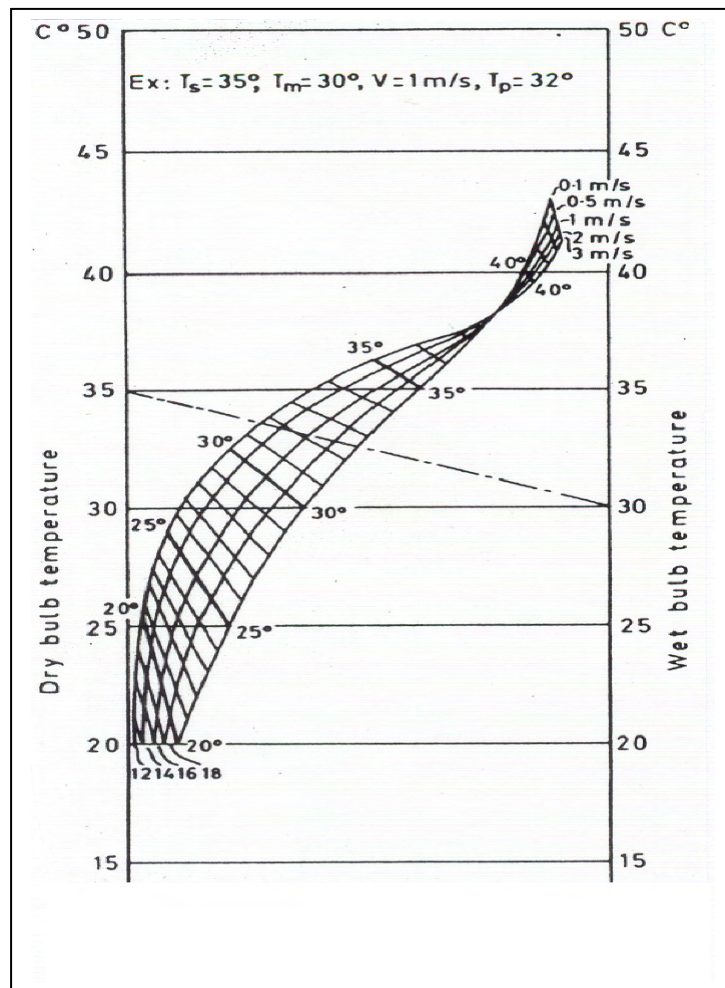

Fig.15 Resultant temperature nomogram by Missénard

Givoni (1969) found that the RT is in better agreement with observed physiological responses than the ET, although below 30°C there is a slight overestimation of humidity effects. The cooling effect of air movement is underestimated at higher levels and overestimated at the lower range. The UK CIBSE adopted the 'dry resultant temperature' (DRT) as the index of warmth with low air speeds, which is defined in section 2.3. and which is not the same as the above.

Givoni, B (1969): *Man, climate and architecture*. Applied Science Publishers
Missénard, A (1935): Teorie simplifié du thermomètre resultant. *Chauffage et Ventilation*, 12:347
Missénard, A (1959): On thermally equivalent environment. *IHVE J*, 27:231

THERMAL COMFORT

2.4.8 Equatorial comfort index (ECI)

Developed by Webb, working in Malaysia and Singapore. It is a further development of his 'Singapore index' published in 1959, which was based on some 393 sets of observations. Subjective responses of fully acclimatised subjects engaged in light sedentary work were recorded, together with measurements of air temperature, humidity and air movement. The data of Bedford (1936) and McArdle et al. (1947) were also used in his analysis. The relationships were organised to produce a formula and expressed in a graph rather similar to the ET nomogram. The upper small graph on the right assists the interpretation of results in terms of 'percentage satisfied'.

The index is defined as the temperature of a still, saturated atmosphere which is physiologically equivalent to the climate in question. The index does not allow for activity levels or clothing different to those of the test subjects. It is claimed to be appropriate for climates beyond the 24°C WBT isotherm (i.e. in warm-humid climates).

The equation of the index is given as

$$ECI = WBT + X (DBT - WBT) - Y (\sqrt{v})$$

The coefficients X and Y are given in graphic form (lower right), as functions of ECI, so several iterations (trial-and-error) may be necessary.

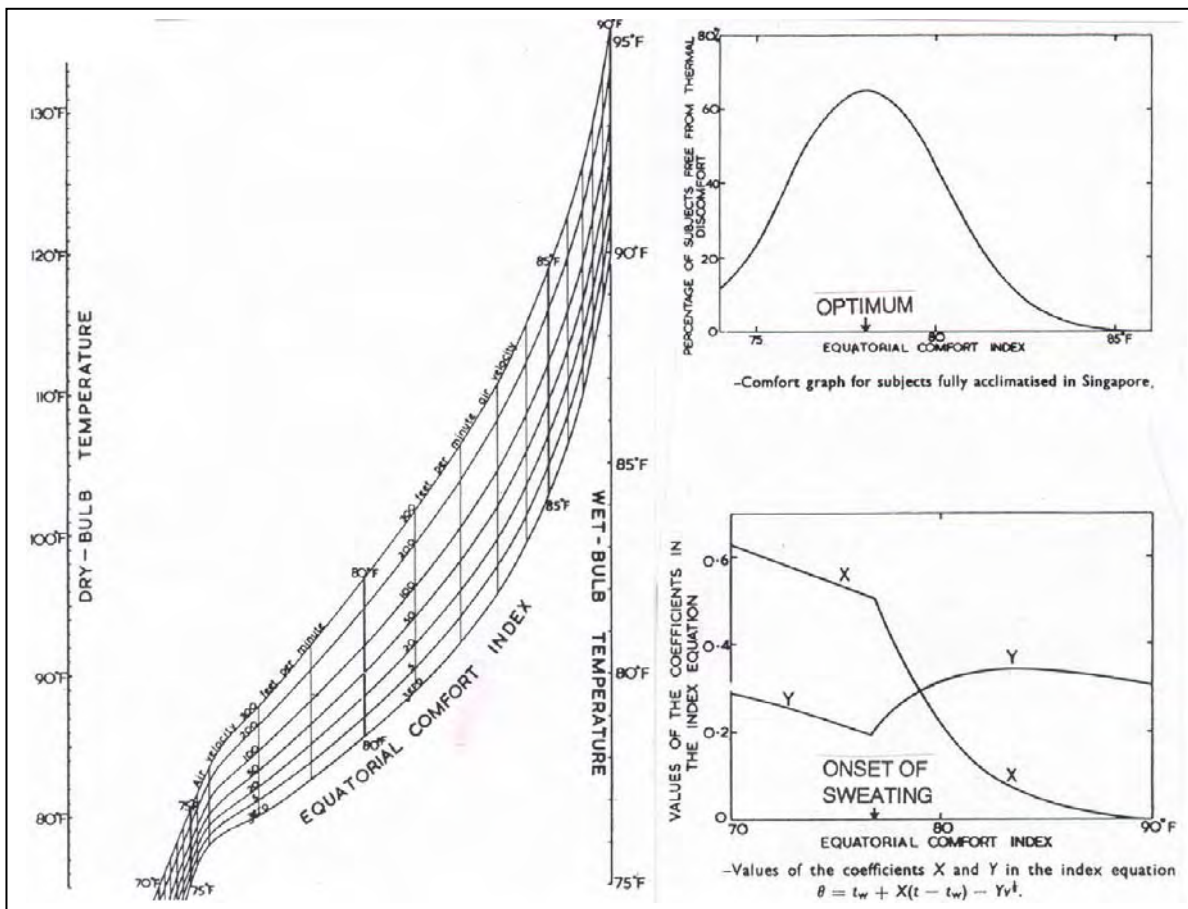

Fig.16 Equatorial comfort index nomogram, by Webb

Webb, C G (1959): An analysis of some observations of thermal comfort in an equatorial climate. *Brit J of Industrial Medicine*, 16(3):297-310

THERMAL COMFORT

Webb, C G (1960): Thermal discomfort in an equatorial climate. *IHVE J* 27:297-304

2.4.9 Tropical summer index (Tsi)

It is somewhat confusing that this index has the same abbreviation as the analytical Thermal Strain Index. To differentiate, we will refer to this one as Tsi (lower case 'si').

The tropical summer index has been developed in the mid-1980s at the Central Building Research Institute, Roorkee (India), for the climatic conditions prevalent in that country and to suit the living habits of its people. It is defined as the temperature of still air, at 50% relative humidity, which causes the same thermal sensation as the given environmental condition. Its mathematical expression is somewhat similar to that of the WBGT, but it includes the air velocity cooling effect and the empirical constants are different:

$$Tsi = 0.308WBT + 0.745GT - 2.06\sqrt{v} + 0.841$$

where WBT = wet bulb temperature (°C)

GT = globe temperature (°C)

v = air velocity (m/s)

For a quick assessment this is simplified to: $Tsi = \frac{1}{3}WBT + \frac{3}{4}GT - 2\sqrt{v}$

It is suggested that if GT readings are not available, GT can be taken as equal to the DBT. If (known) strong directional radiation is present, the GT value can be approximated as 1 K higher for each 90 W/m² irradiance.

The merit of Tsi lies in the fact that it is simple to compute and it is based on the local climatic and social conditions (habits, clothing, etc.) It has not been tested outside that country. Lines of equal Tsi are drawn on a psychrometric chart for still air conditions. Tsi values can then be reduced for air velocity as shown in the table below on the right.

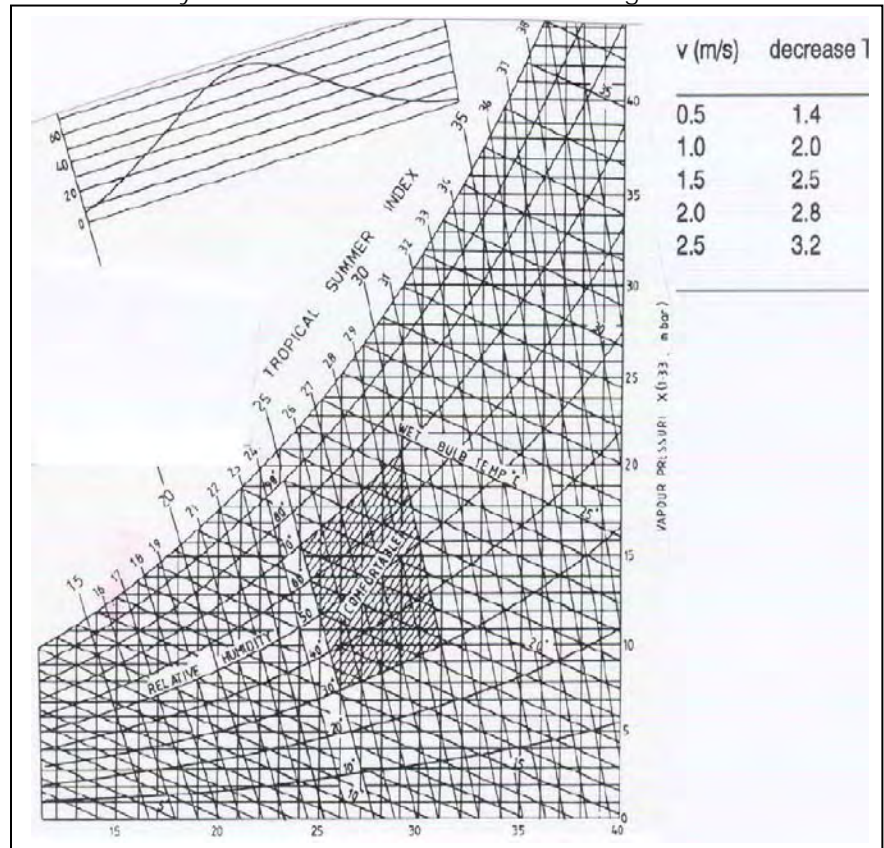

Fig.17 Tropical summer index for still air conditions

THERMAL COMFORT

Bureau of Indian Standards (1987): *Handbook of functional requirements of buildings (other than industrial buildings) SP:41*

2.5 Measures of comfort: analytical indices

2.5.1 Thermal strain index (TSI)

D H K Lee developed this index partly on the basis of observation, partly by analysing the heat transfer mechanisms. He plotted a set of *equal strain lines* on the psychrometric chart. At high levels of strain these are almost parallel with the WBT lines, whilst at low levels they are vertical, coinciding with the DBT lines.

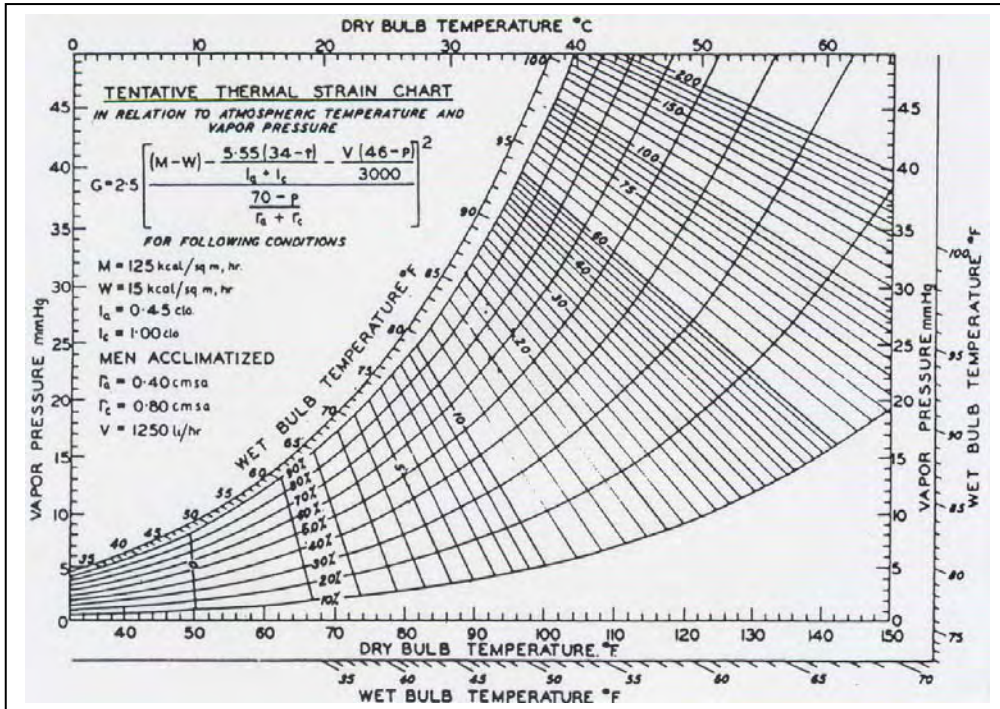

Fig. 2.9 Lee's proposed thermal strain chart (in psychrometric format)

Lee, D H K (1958): *Proprioclimates of man and domestic animals. Climatology: reviews of research.* UNESCO Conf. Paris, 1956.

2.5.2 Thermal Acceptance Ratio (TAR)

Developed at the office of the US Quartermaster General, this is the ratio of the heat acceptance (H_a) potential of an environment from a nude person to the metabolic heat output of that person.

$$TAR = H_a / M$$

$$H_a = E_k(44.8 - p_v) + C_k(97 - DBT) + R_k(97 - MRT)$$

where E_k , C_k and R_k are evaporation, convection and radiation constants and 97°F is assumed to be the skin temperature
 p_v = vapour pressure

This may be applicable to hot environments, but its main significance is that it is the precursor of the later work by Belding and Hatch.

THERMAL COMFORT

Ionides, M, Plummer, J and Siple, P A (1945): *Report from the Climatology and Environment Protection Section, Office of the Quartermaster General (US)*. September 17.

2.5.3 Predicted 4-hour sweat rate (P4SR)

McArdle and his collaborators (1947) carried out work initially for the British naval authorities, performing some 750 observations. The intention was to objectively determine the physical stress by the sweat rate, pulse or internal body temperature. The scale was established on the basis of many different combinations of air temperature, humidity, air movement, mean radiant temperature, metabolic rate and the amount of clothing worn, producing the same sweat rate, thus presumably the same physiological stress. It seems to be the most reliable of thermal indices for high temperature conditions, but not suitable for temperatures below about 28°C. Smith (1955) found better agreement with experimental results at rest than at work and also when wearing shorts rather than overalls. Both Givoni and Macpherson (1962) found good agreement of P4SR with measured results although Givoni (1963) thought that the cooling effect of air movement at high humidities is underestimated (Givoni, 1963).

The index is defined by a nomogram. From measured DBT (or GT) and WBT values first the basic 4-hour sweat rate (B4SR) is found, then adjustments are provided for metabolic rates other than rest (54 kcal/m²h): see insert, e.g. +4°F for 100 kcal/m²h; for MRT different from the DBT (or GT): for each °F difference +0.4(MRT-DBT); and for clothing above 600 g mass (shorts): 1°F added for each 300 g increase.

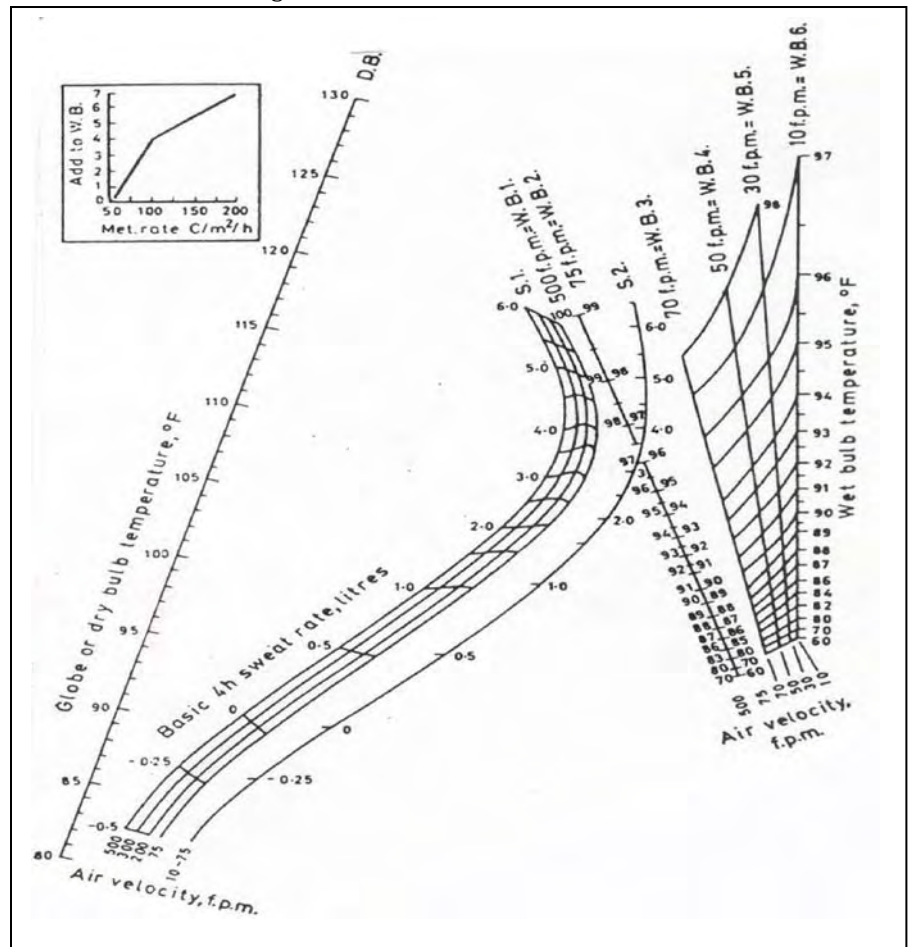

Fig.19 Nomogram for determining P4SR

Givoni, B (1963): *Estimation of the effect of climate on man: developing a new thermal index*. Technion, Haifa

THERMAL COMFORT

McArdle, B et al. (1947): *Prediction of the physiological effect of warm and hot environments*. Med. Res Council, RNP 47/391, HMSO, London

Smith, S E (1955): *Indices of heat stress*. Med Res Council, Special Report 29, London

2.5.4 Heat stress index (HSI)

Belding and Hatch (1955) reported the development of this index. It is defined as the ratio of evaporative cooling required for maintaining heat balance, to the maximum evaporative cooling possible under the given conditions.

$$\text{HSI} = (E_{\text{reqd}}/E_{\text{max}}) \cdot 100$$

(with an upper limit of E_{max} at 700 W, or a little over 1 L/h evaporation)

This can be expressed as a function of metabolic rate, air and wall surface temperatures, air movement and vapour pressure. The theoretical formulation was correlated with experimental findings.

$$\text{HSI} = \frac{M + 22(t_w - 95) + 2 \cdot v^{0.5}(\text{DBT} - 95)}{10.3 \cdot v^{0.4}(42 - p_a)}$$

where M metabolic rate (Btu/h)
 t_w temperature of walls (°F)
DBT air temperature (°F)
 v air velocity (ft/min)
 p_a vapour pressure (mmHg)
42 mmHg is the vapour pressure of skin at 95°F (35°C)

The scale is thought to be reliable for still air between 27 and 35°C, 30-80% RH and for higher temperatures with lower humidities, but it exaggerates the effect of air movement with lower humidities and the effect of high humidities for medium to high temperatures. It is not suitable for the comfort zone or conditions below comfort level. Others found that it strongly overestimates the magnitude of thermal stress.

Interpretation of HSI values for 8-hour exposure:

-10 to -20	mild cold strain
0	no strain
10 - 30	mild to moderate strain
40 - 60	severe strain, health threat, decreased work performance
70 - 90	very severe, tolerated only by fit and acclimatised people
100	the maximum tolerated only by the most fit and acclimatised young men; the upper limit of thermal equilibrium, with a sweat rate of 1 L/h, above which body heating would occur which can be tolerated for short periods and only up to 1.8 K

Givoni (1969) recognises the theoretical importance of this index, but doubts its suitability for the quantitative assessment of heat stress; the main problem being that it is based on a naked 'standard man'. In his view HSI overestimates the cooling effect of air movement and the 'warming effect' of humidity.

Belding, H S & Hatch, T F (1955): Index for evaluating heat stress in terms of resulting physiological strains. *Am J Heat Pip Air Cond.* 27(8):129-136

Belding, H S & Hatch, T F (1956): Index for evaluating heat stress in terms of resulting physiological strains. *ASHRAE Trans.* 62:213-236

THERMAL COMFORT

Macpherson, R K (1962): The assessment of the thermal environment: a review. *Brit J industrial Med.* 19:151-164

Nelson, N et al.(1947): Thermal exchanges of men at high temperatures. *Am.J. Physiol.* 151:626

2.5.5 Relative strain index (RSI)

Lee and Henschel (1963) working for the US Department of Health have further developed the work of Belding and Hatch. They defined the relative strain index as

$$RSI = \frac{M(I_{cl} + I_a) + 5.55(DBT - 35) + R.I_a}{7.5(44 - p_a)}$$

or in metric SI units:

$$RSI = \frac{M(I_{cl} + I_a) + 6.45(DBT - 35) + R.I_a}{0.0654(5866 - p_a)}$$

where M = metabolic rate (kcal/m²h, or W/m²)
 DBT = air temperature (°C)
 R = mean radiant energy incidence (kcal/m²h, or W/m²)
 I_a = insulation of air (clothing surface resistance: clo units)
 I_{cl} = insulation of clothing (clo units)
 p_a = vapour pressure of air (mmHg, or in Pa)

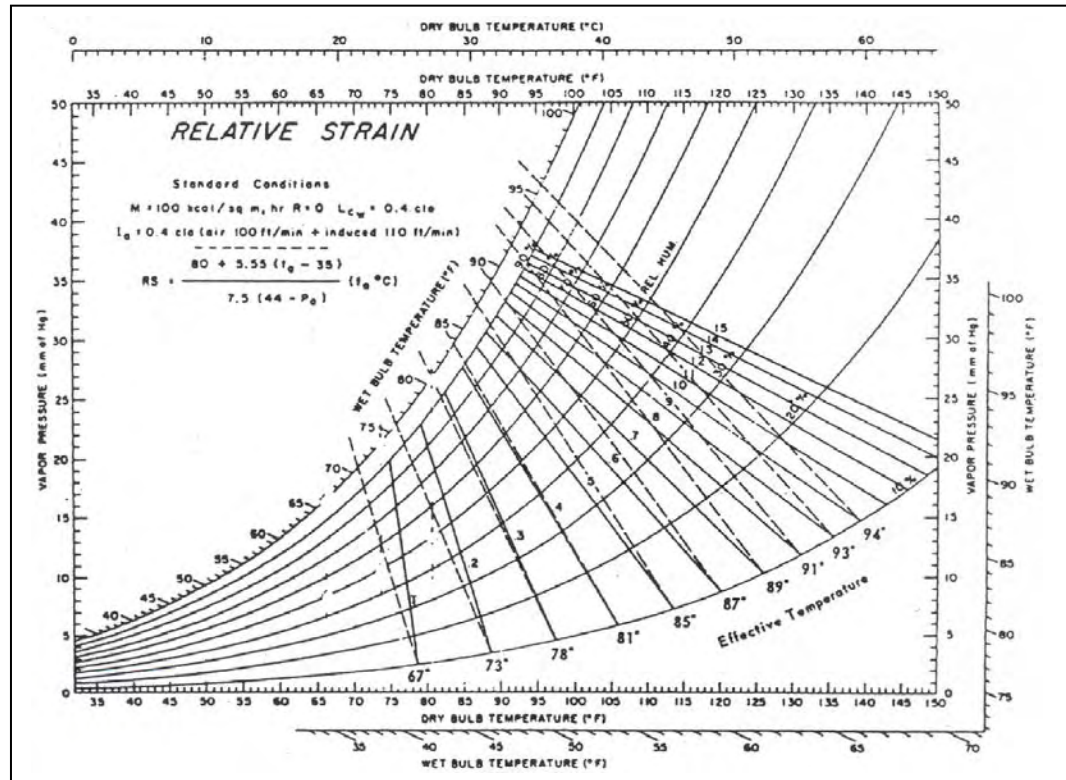

Fig.20 The psychrometric chart with RSI lines (0.1 - 1.5) superimposed

RSI values can be interpreted as follows:

below	0.1	all comfortable
at	0.2	85% comfortable, 15% too warm
at	0.25	50% comfortable, 50% too warm
at	0.3	none comfortable, 50% too hot
at	0.4	75% show distress, some failure
at	0.5	all too hot, all show signs of distress
above	0.5	too hot to endure

In the 24 - 27°C range RSI values closely agree with ET. At higher temperatures in the high humidity range the ET underestimates the stress, compared with the RSI.

THERMAL COMFORT

Lee, D H K & Henschel, A (1963): Evaluation of thermal environment in shelters. *Trans US Dept of Health Educ & Welfare*. p.58

2.5.6 Index of thermal stress (ITS)

Givoni, working during the same period, published his new index first in 1963 (later included in his 1969 book). This index is the calculated cooling rate produced by sweating, which would maintain thermal equilibrium under the given conditions. Calculation is based on a refined biophysical model of the man-environment thermal system. Its usefulness extends from comfortable to overheated conditions, as far as physiological adjustments are (or would be) able to maintain a thermal equilibrium.

The net energy balance formulated by Givoni is (unfortunately he uses obsolete metric units, such as kcal):

$$E = (M - W) \pm C \pm R \quad \text{where } \begin{array}{l} M = \text{metabolic rate} \\ W = \text{metabolic rate converted to work} \\ C = \text{convective exchange} \\ R = \text{radiative exchange} \end{array} \quad \text{all in kcal/h}$$

This must equal the sweat rate times its cooling efficiency
 $S * f = E$ where S = required sweat cooling rate, in kcal/h
 f = cooling efficiency of sweating

therefore $S = E * 1/f$
 $W = 0.2(M - 100)$ where 0.2 = assumed mechanical efficiency
 100 kcal/h = rest level metabolic rate

$C = \alpha v^{0.3} (t_a - 35)$ where α = clothing surface coefficient
 v = air velocity (m/s)
 t_a = air temperature (°C)

$R = G_n K_{pe} K_{cl} [1 - a(v^{0.2} - 0.88)]$ where G_n = normal solar irradiance (kcal/(h.m²))
 K_{pe} = posture/environment coefficient
 K_{cl} and a = clothing coefficients

Evaporative capacity is
 $E_{max} = p * v^{0.3} (42 - pv)$ where p = clothing coefficient (permeance)
 42 mmHg is vapour pressure of skin (35°C)
 pv = vapour pressure of air

Reciprocal of efficiency is
 $\frac{1}{f} = \exp \left[0.6 \left(\frac{E}{E_{max}} - 0.12 \right) \right]$ with values between 1 and 3.5

Thus the full expression becomes

$$S = \left\{ M - 0.2(M - 100) \pm \alpha v^{0.3} (t_a - 35) + G_n K_{pe} K_{cl} [1 - a(v^{0.2} - 0.88)] \right\} \cdot \exp \left[0.6 \left(\frac{E}{E_{max}} - 0.12 \right) \right]$$

Clothing coefficients	α	K_{CL}	a	p
semi-nude, bathing suit	15.8	1.0	0.35	31.6
light summer clothing	13.0	0.5	0.52	20.5
overalls over shorts	11.6	0.4	0.52	13.0

Posture/environment coefficients K_{pe}	desert	forest
	sitting with back to sun	0.386
standing with back to sun	0.306	0.266

THERMAL COMFORT

Givoni, B (1963): *Estimation of the effect of climate on man: developing a new thermal index*. Technion, Haifa

Givoni, B (1969): *Man, climate and architecture*. Elsevier, Amsterdam

2.5.7 Predicted mean vote (PMV)

PMV is expressed in terms of the ASHRAE comfort scale shown in Table 4, in para 2.1. The thermal load is calculated from a rearranged form of eq. 2.7 given in section 2.2.2:

$$TL = H - E_{diff} - E_{rs} - E_{resp} - L - R - C$$

The mean vote (Y) from a large number of laboratory studies has been correlated with the thermal load (TL) and produced the following equation (using obsolete metric units):

$$\frac{\delta Y}{\delta TL} = 0.352 \exp\left(-0.042 \frac{M}{A_D}\right) + 0.032$$

thus the mean vote will be

$$Y = \left(0.352 \exp\left(-0.042 \frac{M}{A_D}\right) + 0.032\right) TL$$

Substituting all the terms the full PMV equation will be (see footnote)

$$PMV = \left[0.352 \exp\left(-0.042 \frac{M}{A_D}\right) + 0.032\right] \cdot \left\{ \frac{M}{A_D} (1 - \eta) - 0.35 \left[43 - 0.061 \frac{M}{A_D} (1 - \eta) - p_a\right] - 0.42 \left[\frac{M}{A_D} (1 - \eta) - 50\right] - 0.0023 \frac{M}{A_D} (44 - p_a) - 0.0014 \frac{M}{A_D} (34 - t_a) - 3.4 \cdot 10^{-8} f_{cl} \left[(t_{cl} + 273)^4 - (t_r + 273)^4\right] + f_{cl} h_c (t_{cl} - t_a) \right\}$$

where t_{cl} is found by iteration from

$$t_{cl} = 35.7 - 0.032 \frac{M}{A_D} (1 - \eta) - 0.18 I_{cl} \left\{ 3.4 \cdot 10^{-8} f_{cl} \left[(t_{cl} + 273)^4 - (t_r + 273)^4\right] \dots + f_{cl} h_c (t_{cl} - t_a) \right\}$$

the value of h_c is taken as stated for eq.2.14 (p.20)

Examination of a large volume of test data shows that some 5% of the population would be dissatisfied even under the "best" conditions, at the best PMV = 0 level. With departure from this, the percentage dissatisfied rapidly increases. The empirical curve below shows the PPD (predicted percentage dissatisfied) as a function of PMV (note that at least 5% of the population would be dissatisfied even under the "best" conditions).

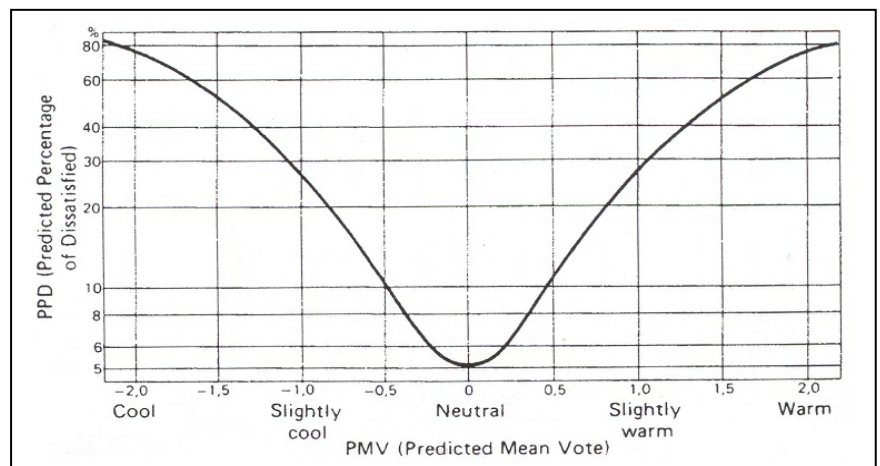

Fig.21 Predicted mean vote (note that at least 5% of any population would be dissatisfied even under the 'best' conditions)

THERMAL COMFORT

In the first line of the PMV expression, for W/m^2 units the three constants are: 0.303 (in lieu of 0.352), 0.036 (in lieu of 0.042) and 0.028 (in lieu of 0.032)

Fanger, P O (1982): *Thermal comfort*. Kreiger, Florida

2.5.8 New effective temperature (ET*)

ET* has been developed using the 'two-node model' described in section 2.2.1. It is defined as the temperature (DBT) of a uniform enclosure at 50% relative humidity, which would produce the same net heat exchange by radiation, convection and evaporation as the environment in question.

ET* lines coincide with DBT values at the 50% RH curve. Radiation is taken into account by using OT on the horizontal scale instead of DBT. The ET* lines are shown on the psychrometric chart for the following conditions: clothing: 0.6 clo, activity: 1 met, air movement = < 0.2 m/s, exposure time: 1 hour

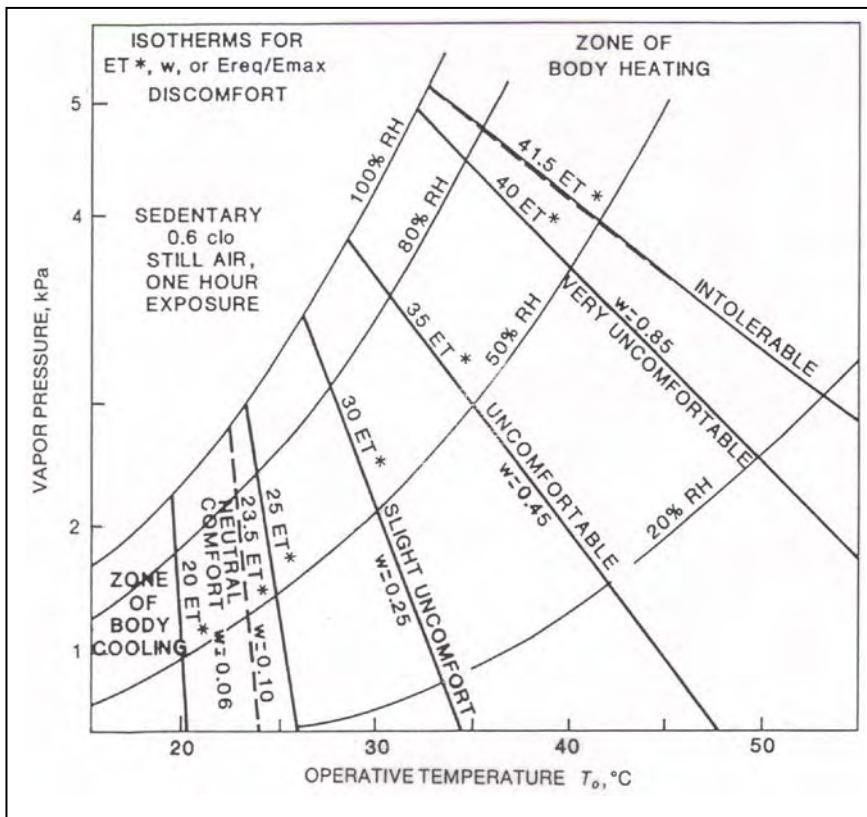

Fig.22 Psychrometric chart showing constant ET* lines

The old ET lines are parallel with the 30°C ET* line and for high air movements the WBGT lines are parallel with the 35°C ET* line. The ET* lines show good correspondence with isotherms for skin wettedness, skin temperature, discomfort votes and heart rate.

Summer upper comfort limit, for subjects wearing 0.5 clo is set as 26°C ET* with 0.2 m/s air movement. This can be extended by 1 K for each 0.275 m/s increase in air velocity, up to 28°C ET* with 0.8 m/s air velocity.

Gagge, A P, Stolwijk, J A J & Nishi, Y (1971): An effective temperature scale based on a simple model of human physiological regulatory response. *ASHRAE Trans.* 77(pt.1):247-262

THERMAL COMFORT

- Gagge, A P, Gonzales, R R & Nishi, Y (1974): Physiological and physical factors governing man's thermal comfort, discomfort and heat tolerance. *Build International*, 7:305-331
- Rohles, F H, Hayter, R B & Milliken, G (1975): Effective temperature (ET*) as a predictor of thermal comfort. *ASHRAE Trans.* 81(pt.2):148-156

In accordance with the 2-node model, the method of setting out the ET* lines on the psychrometric chart consists of the following steps:

(for the illustrative example: comfort condition, the following values are used:

$$M = 58.2 \text{ W/m}^2 \quad h' = 4.56 \text{ W/m}^2\text{K} \quad t_{sk} = 33.5^\circ\text{C}$$

$$M_{sk} = 52.4 \text{ W/m}^2 \quad h_e = 0.04 \text{ W/m}^2\text{Pa} \quad w = 0.06$$

1. mark the skin temperature (t_{sk} , eg. 33.5°C) on the X axis and project it up to the saturation curve (PSK); on the Y axis this gives the saturation vapour pressure of the skin (P_{ssk} , = 5.33 kPa); extend this line (parallel with the X-axis) to the left
2. the quotient of metabolic heat reaching the skin and the heat loss coefficient gives a temperature difference:

$$\frac{M_{sk}}{h'} \rightarrow \frac{\text{W/m}^2}{\text{W/m}^2\text{K}} = \text{K} \quad \text{e.g. } \frac{52.4}{4.56} = 11.5\text{K}$$

3. subtract this from the t_{sk} and mark it on the X-axis; project it up to the extended P_{ssk} -PSK line to define the point CP, the starting point of the corresponding ET* line
4. if Ψ is used to denote the ratio of the combined to the evaporative heat loss coefficient:

$$\Psi = \frac{h'}{h_e} \rightarrow \frac{\text{W/m}^2\text{K}}{\text{W/m}^2\text{Pa}} = \frac{\text{Pa}}{\text{K}} \quad \text{e.g. } \frac{4.56}{0.04} = 114 \frac{\text{Pa}}{\text{K}}$$

5. then this, divided by the skin wettedness (w , non-dimensional) gives the negative slope of the ET* line:

$$\frac{114}{0.06} = 1.9 \frac{\text{kPa}}{\text{K}}$$

6. as $P_{ssk} = 5.33 \text{ kPa}$, the base line (X-axis) intercept of the ET* will be

$$22 + \frac{5.33}{1.9} = 24.8^\circ\text{C}$$

7. this ET* line intersects the 50% RH curve at 24°C DBT, thus it will be calibrated as 24°C ET*

For each subsequent ET* line the location of CP differs, the process must be repeated with the appropriate values and coefficients.

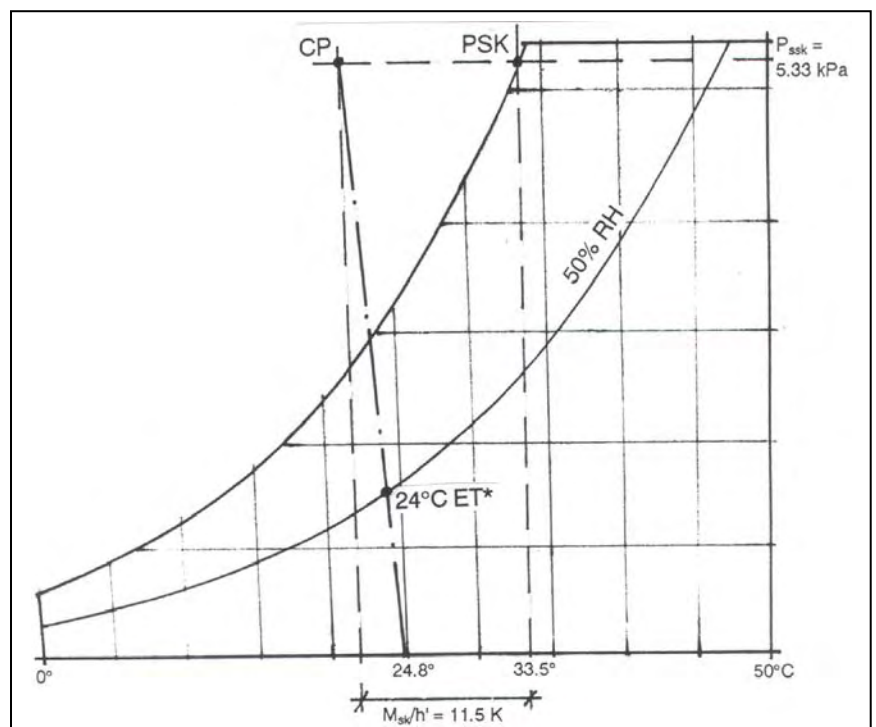

Fig.23 Setting out the ET* isotherm lines

Approximation of ET*

The slope of ET* lines shows an irregularity (they are constructed by a complicated geometric process as described above). In order to facilitate the use of ET* in a computer algorithm a simple function has been produced which approximates the ET* lines (Szokolay, 1991): a negative slope of $X/Y = 0.023 (T-14)$. (up to 14°C the ET* lines are vertical, same as DBT).

The temperature in question (T) is plotted on the 50% RH curve and the corresponding absolute humidity is read (AH_T).

The base-line intercept (DBT_b) of the ET* line will be

$$DBT_b = T + 0.023 (T-14) AH_T \quad \dots 2.16)$$

The graph below compares the ET* lines with their approximation by this function (which is quite good for 'normal' conditions up to about 32°C ET*)

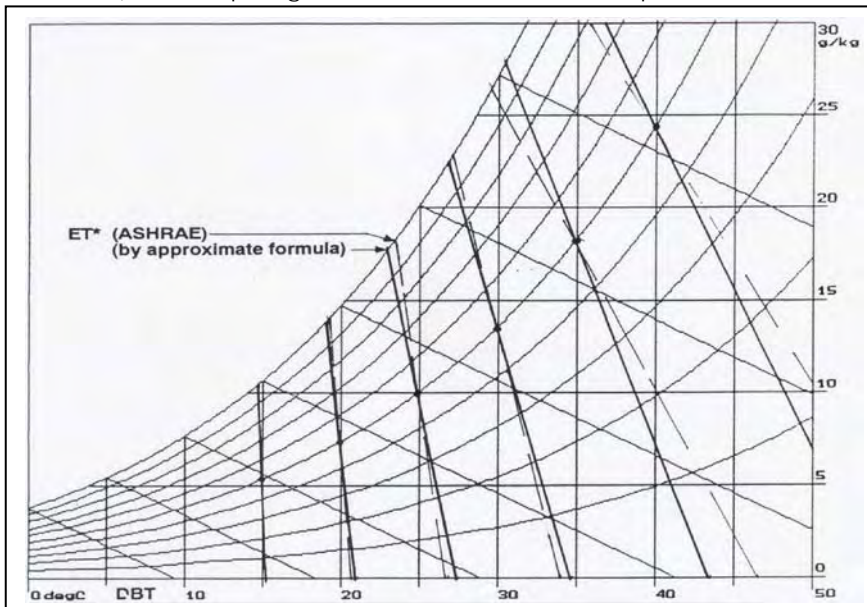

Fig.24 Comparison of ET* and its approximation

The following algorithm can be used to find the AH_T value:
First the saturation vapour pressure (p_{vs}) is found for temperature T

$$K = 673.4 - 1.8 T$$

$$A = 3.2437814 + 0.00326014 * K + 2.00658 * 10^{-9} * K^3$$

$$B = (1165.09 - K) * (1 + 0.00121547 * K)$$

$$C = 2.302585 * K * A / B$$

$$pvs = 22105.8416 / \exp(C) \quad \text{in kPa}$$

or a simpler, but less accurate algorithm:

$$pvs = 0.133322 * \exp[18.6686 - 4030.183 / (T+235)] \quad \text{in kPa}$$

The corresponding saturation humidity is

$$Y_s = 622 * pvs / (pt - pvs) \quad \text{in g/kg}$$

where pt = 101.325 kPa, the total standard atmospheric pressure.

The AH_T used in expression (2.16) will be half of this value (for 50% RH).

The ASHRAE Handbook of Fundamentals (1997) offers the following expression for the calculation of ET*:

$$ET^* = OT + w * i_m * LR * (p_a - 0.5 * p_{SEt})$$

THERMAL COMFORT

This is however a circular definition, as the saturation vapour pressure at $ET^*(p_{SET})$ must be known in order to calculate ET^* (!) This problem may be solved by an iterative (trial-and-error) process, but the calculation of skin wettedness (w) and the permeation efficiency of clothing (l_m) requires the assumption of several input variables, hence the approximation offered above is no less reliable.

2.5.9 Standard effective temperature (SET)

SET has been interpreted by Gagge et al.(1986) as a sub-set of ET^* under standardised conditions: clothing standardised for given activities (thus the effective heat transfer coefficients h'_s and h'_{es}). Then the process of standardisation was continued in terms of metabolic rate and clothing and establish that an inverse change of clo can compensate for an increase of met. Thus the following equivalence was suggested (pairs, which would give the same SET value):

1 met	0.67 clo
1.25	0.57
2	0.39
3	0.26
4	0.19

At sea level, under the above standard environmental conditions $SET \equiv ET^*$
At higher levels of ET^* the difference between the two scales increases: with greater skin wettedness the influence of barometric pressure is increasing.

In thermal equilibrium (storage component $\Delta S = 0$) between 23°C and 41°C SET is linearly related to average body temperature:

$$SET = 34.95 T_b - 1247.6$$

below 23°C the relationship is:

$$SET = 23 - 6.13 (36.4 - T_b)^{0.7}$$

and above 41°C:

$$SET = 41 + 5.58 (T_b - 36.9)^{0.87}$$

The measurement procedure is to determine DBT and MRT (or OT), then air velocity (v), evaluate the metabolic rate (M) and clothing (clo), then predict the average body temperature (T_b) (by using the two-node model). T_b has been calculated for a wide range of metabolic rates, clothing levels, air movement and atmospheric pressure, as well as the air temperature, mean radiant temperature and humidity catered for by the SET. For standard conditions (1.1 met) it is taken as 36.35°C and the following table gives some guidance:

SET	T_b
10	33.90
14	34.55
18	35.63
22	36.27
26	36.44
30	36.55
34	36.67
38	36.78
42	36.97

SET gives a rational basis for measuring the equivalence of any combination of environmental factors, clothing and metabolic rate

The following table relates SET to comfort votes, sensation and physiology:

SET	vote	sensation	physiology
> 37.5	> 3	very hot, great discomfort	incr.failure of evaporative regulation
37.5-34.5	+2 to +3	hot, very unacceptable	profuse sweating
34.5-30	+1 to +2	warm, uncomfortable, unacceptable	sweating
30-25.6	+0.5 to +1	slightly warm, slightly unacceptable	slight sweat, vasodilation
25.6-22.2	-0.5, +0.5	comfortable, acceptable	physiological thermal neutrality

THERMAL COMFORT

22.2-17.5	-1 to -0.5	slightly cool, slightly unacceptable	initial vasoconstriction
17.5-14.5	-2 to -1	cool, unacceptable	slow body cooling
14.5-10	-3 to -2	cold, very unacceptable	beginning of shivering

(for references see overpage)

Gagge, AP, Fobelets, AP, Berglund, LG(1986): A standard predictive index of human response to the thermal environment. *ASHRAE Trans. 92(pt.2):709-731*

Nishi, Y and Gagge, A P (1977): Effective temperature scale useful for hypo- and hyperbaric environments. *Aviation, Space and Env. Medicine*, Feb. p.97.

Gonzales, R R, Nishi, Y and Gagge A P (1974): Experimental evaluation of standard effective temperature: A new biometeorological index of man's thermal discomfort. *Int.J.Biometeorology. 18:1-15*

2.5.10 Subjective temperature (ST)

McIntyre (1976) proposed this index, which is oriented towards the design professions. It focuses on two questions:

- 1) what 'temperature' is required by the occupants
- 2) what physical factors will produce that 'temperature'.

It is defined as ' temperature of a uniform enclosure, with DBT = MRT, $v < 0.1$ m/s, 50% RH, which would produce the same feeling of warmth as the environment considered, for people at the same activity level and wearing the same clothing.

- 1) The preferred temperature is
 $ST = 33.5 - 3 I_{cl} - (0.08 + 0.05 I_{cl}) H$

where $H = M (1-\eta)$, i.e. the heat production of the body
 I_{clo} is given in clo units

Up to 1.5 clo and an H of 150 W/m² this gives a good approximation of Fanger's comfort equation.

$$2) \quad ST = 0.56DBT + 0.44MRT \quad \text{for } v < 0.15 \text{ m/s}$$

$$ST = \frac{0.44MRT + 0.56(5 - \sqrt{10v})(5 - DBT)}{0.44 + 0.56\sqrt{10v}} \quad \text{for } v > 0.15 \text{ m/s}$$

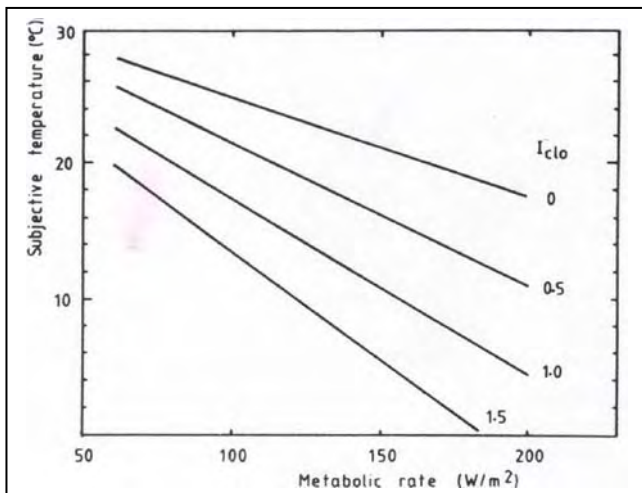

Fig.25 ST values required for comfort

If GT is measured by a 25 or 40 mm diameter black globe, then the calculation becomes even simpler:

$$ST = \frac{GT + 2.8(1 - \sqrt{10v})}{0.44 + 0.56\sqrt{10v}}$$

THERMAL COMFORT

The index has no theoretical basis, but it is easy to use and at or near comfort conditions it gives a good agreement with SET. The graph above gives values of ST required for comfort for different metabolic rates and clothing.

McIntyre, D A (1976): *Subjective temperature: a simple index of warmth*. ECRC/M916. Electricity Council Research Centre, Chester, UK

2.5.11 Index of thermal sensation (TS and DISC)

Gagge's DISC, or discomfort index is similar to Fanger's PMV. Its numerical value is a vote on the 7-point scale (see Table 4, p. 15).

For warm conditions it is a function of skin wettedness (w , see section 2.2.1, top of p.18):

$$\text{DISC} = 5*(w-0.06)$$

but it can also be derived from a pre-calculated SET value:

$$\text{DISC} = 0.00543*(\text{SET}-17.5)^{2.12}$$

TS is an index of thermal sensation, using the ASHRAE scale but extending it to 10 points: -4 for very cold, +4 very hot and +5 for painfully hot). For warm conditions this is identical with the above DISC, but for all conditions (including cold) it can be estimated using the regression equations (Table 5) which have been published by the Kansas State University research group as a function of DBT, p_v (vapour pressure) and duration of exposure.

TABLE 5 Equations for thermal sensation (TS)

exposure	gender		DBT in °C	p_v in kPa
1 hour	males	TS =	0.220 DBT +	0.233 p_v - 5.673
	females	TS =	0.272 DBT +	0.248 p_v - 7.245
	combined	TS =	0.245 DBT +	0.248 p_v - 6.475
2 hours	males	TS =	0.221 DBT +	0.270 p_v - 6.024
	females	TS =	0.283 DBT +	0.210 p_v - 7.694
	combined	TS =	0.252 DBT +	0.240 p_v - 6.859
3 hours	males	TS =	0.212 DBT +	0.293 p_v - 5.949
	females	TS =	0.275 DBT +	0.255 p_v - 8.622
	combined	TS =	0.243 DBT +	0.278 p_v - 6.802

(for young adult subjects at sedentary activity, wearing 0.5 clo when MRT = DBT and $v < 0.2$ m/s)

Markus, T A & Morris, E N (1980): *Buildings, climate and energy*. Pitman, London

THERMAL COMFORT

Rohles, F H & Nevins, R G (1971): The nature of thermal comfort for sedentary man, *ASHRAE Trans.* 77(I):239

Rohles, F H (1973): The revised modal comfort envelope. *ASHRAE Trans.* 79(II):52

Rohles, F H, Hayter, R B & Milliken, G (1975): Effective temperature (ET*) as a predictor of thermal comfort. *ASHRAE Trans.* 81(II):148-156

2.6 Discussion of indices

Thermal comfort indices have been employed for several different purposes:

- i. Setting exposure limits or thresholds. As Lee (1980) suggested these may be (a) limits not to be exceeded or (b) precautionary limits. For these purposes the WBGT is quite adequate.
- ii. Defining comfort, the limits of comfort, i.e. the 'comfort zone', which is applicable in residential or office situations. Lee considered that the ET* (or SET) index is the most appropriate for this purpose, provided that allowance is made for acclimatisation.
- iii. Evaluating past exposures, e.g. for the purposes of compensation (even court cases), which would require a method more sensitive than the WBGT, probably one of the stress/strain indices.
- iv. Determining the optimum control measures (e.g. choice between air movement or air conditioning; screening against radiant heat (in industry) or reducing the exposure period): for this the individual contributing variables must be examined.
- v. Climate classification: zones determined by individual variables (e.g. DBT or RH) are not very useful, in a number of cases one of the stress/strain indices have been used.

Fanger's (1970) comfort equation (section 2.2.2) is probably the most meticulous and detailed analysis of human thermal relationship with the proximal environment. His analytical index, the PMV (predicted mean vote) with the PPD (predicted percentage dissatisfied, section 2.5.7) form the basis of and are incorporated in ISO 7730:1994, *Determination of the PMV and PPD indices and specification of conditions for thermal comfort*, as well as several national standards.

The two-node model of the J B Pierce laboratories and the ET* (and SET) indices derived from this, form the basis of ASHRAE standard 55-1992: *Thermal environmental conditions for human occupancy*. It is suggested that for general everyday work the SET scale is the most appropriate, provided that the met and clo combinations are at or near the values shown in section 2.5.9 above. The psychrometric chart with SET lines superimposed is shown as Fig. 39 below.

In a recent paper however Williamson et al. (1995) showed that *the PMV strongly overestimates warm discomfort, especially in warm climates*. Karyono (1996) also found (in Indonesia) that people in warm-humid climates prefer up to 6 K higher temperatures than those predicted by ISO 7730. Humphreys and Nicol (1996) showed the errors inherent in the static model (see also section 3.1.1 and 3.1.2).

Much earlier Macpherson (1962) suggested that there are many factors not recognised by the various indices, *the most important of these is acclimatization*. The static models, especially the PMV approach denies the role of acclimatization. (Physiological aspects of acclimatization are mentioned in section 1.3 and it will be further discussed in section 3.1.3.)

THERMAL COMFORT

It should be noted that many workers used the DBT as an index of thermal comfort or neutrality (or the OT, operative temperature, which is the same as DBT, if the MRT equals DBT). This trend can be traced back to Drysdale (1950), who demonstrated that at or near comfort level the best measure of thermal conditions is the dry bulb temperature.

Macpherson (1962) agreed: *The simpler the index chosen, the more likely it is to prove satisfactory and the simplest index of all is the DBT; and further: under ordinary conditions in still air the DBT in itself is a better index of warmth than is effective temperature and any other composite index.*

It can be concluded that DBT is the most useful measure for the specification of comfort, but for the measurement of the magnitude of discomfort or stress some other measure must be found, which recognises the other environmental factors: humidity, radiation and air movement.

2.7 Non-uniform environments

Near to or below the lower limits of comfort localised effects may deteriorate the thermal environment. The general conditions in an enclosed space may be acceptable, but discomfort may be caused by localised differentials over the body surface. These may be caused by "draughts" (localised air movements) or asymmetrical radiation. The two effects often overlap: they are perceived by the same temperature sensors of the skin.

Sitting in front of an open fireplace in an otherwise underheated room would cause the "scorched face, frozen back" sensation. The MRT (mean radiant temperature) may be within acceptable limits, but the radiation is strongly mono-directional. Cold room surfaces may cause radiation emission from the body in all directions, except the fireplace, which causes a strong radiation input. Similar effects can be produced by other forms of radiant heating.

Infiltration of cold air into a heated room can produce a localised air movement: a draught, as it not only produces a measurable velocity, but it is also of a lower temperature. However, even if there is no actual air infiltration, a cold window pane would cool the adjacent air, cause a downward air current, perceived (and measured) as a draught. Furthermore, at times when there is no measurable air movement at the body surface, the subject may perceive the strong monodirectional radiation towards the window pane as a "draught".

As a general guidance it can be suggested that in a heated space

- air movement should not exceed 0.25 m/s
- an MRT slightly higher than the DBT is preferred
- the MRT may be 2 K higher or 1 K lower than the DBT
- the MRT may be 2 K lower than the DBT only if the radiant field is uniform (all surface temperatures are practically the same).

There are no precise prescriptions, as the factors of influence are very complex and interrelated. In an underheated space a higher MRT and mono-directional radiation is accepted, but around the lower comfort limit a lower temperature extended radiant surface is preferred to a small area high temperature radiator.

Timing and time sequence are also influential: a person exposed to underheated conditions will welcome a strong and concentrated radiant heat input, but the same will become unacceptable after a period of adjustment. This effect also appears when conditions are overheated: the cold air curtain at the entrance of a building is very refreshing, but would not be tolerated for more than a few minutes.

THERMAL COMFORT

Anecdotal evidence suggests that there may even be individual differences: people have different "sensitive spots", e.g. feet, neck, lower back; if the otherwise warm-comfortable person gets one of these spots exposed to a lower temperature, this may trigger off a bout of sneezing.

Much work has been done on the problems of non-uniformity in the context of radiant heating systems. The criteria are

- 1) the temperature of the radiant surface above the MRT and
- 2) the angle factor (shape factor), which is dependent on the solid angle subtended by the radiant source and its position relative to the subject.

For sedentary subjects the recommended limit is that the product of these two terms should remain between the following values (ASHRAE, 1985):

$$(-2.4 - 1.8 \cdot I_{cl}) < \Delta t_w \cdot F_{p-w} < (3.9 + 1.8 \cdot I_{cl})$$

where

- I_{cl} = clo value of clothing
- F_{p-w} = angle-(shape-) factor between subject and radiant source
- Δt_w = temperature elevation of radiant source above MRT
(in relation to the subject)

Other authors¹ proposed limits stricter than the above ^{2,3}

¹ Olesen, S et al. (1973): Comfort limits for man exposed to asymmetric thermal radiation. *Proc.CIB Commission W45 Symposium*, BRS, Sept. HMSO, London

² McNall, P E & Biddison, R E (1970): Thermal comfort sensations of sedentary persons exposed to asymmetric radiant fields. *ASHRAE Trans.* 76(I):123

³ Chrenko, F A (1953): Heated ceilings and comfort. *J of IHVE*, 20:375 and 21:145

PART 3 RECENT DEVELOPMENTS

3.1 Adaptation

3.1.1 Review of field studies

Almost invariably, the indices of warmth as described in the preceding section were established from controlled chamber studies with fit young Americans and Europeans. Inevitably they specify an optimum value that has been assumed to apply equally to all people. Fanger categorically stated that his comfort equation and PMV index are valid for all humans and that thermal preferences of humans are the same regardless of geographical location or climate. However, field investigations, using 'real' people engaged in 'real' tasks in 'real' built environments, rather than laboratory experiments into thermal comfort, have produced seemingly anomalous observations that suggest that people's thermal preference also has a geographic component.

Humphreys' (1975) review of available field data found a strong statistical dependence of thermal neutralities (T_n) or temperatures at which minimal stress was reported on verbal scales on mean levels of air or globe temperature (T_i) experienced by the respondents (indoor or outdoors) over a period of approximately a month. The value of T_n was found to be ranging over some 13 K, i.e. from 17 to over 30°C and found the correlation:

$$T_n = 2.56 + 0.83 \cdot T_i \quad (r=0.96) \quad \dots 3.1$$

A subsequent analysis (Humphreys,1976), substituting outdoor mean temperatures (T_m) for those indoors, produced similar results in " free-running" buildings with no HVAC facilities in use at the time of the survey:

$$T_n = 11.9 + 0.534 \cdot T_m \quad (r=0.97) \quad \dots 3.2$$

Very similar correlations have been found subsequently by Auliciems (1981) using an enlarged data base, including all buildings (both free-running and conditioned) and this was found to be valid for T_n between 18 and 28°C (see Fig.26):

$$T_n = 17.6 + 0.31 \cdot T_m \quad (r=0.88) \quad \dots 3.3$$

(for free-running buildings the correlation coefficient was $r=0.95$)

The finding of a recent major study (de Dear et al, 1997) is almost identical

$$T_n = 17.8 + 0.31 \cdot T_m \quad \dots 3.4$$

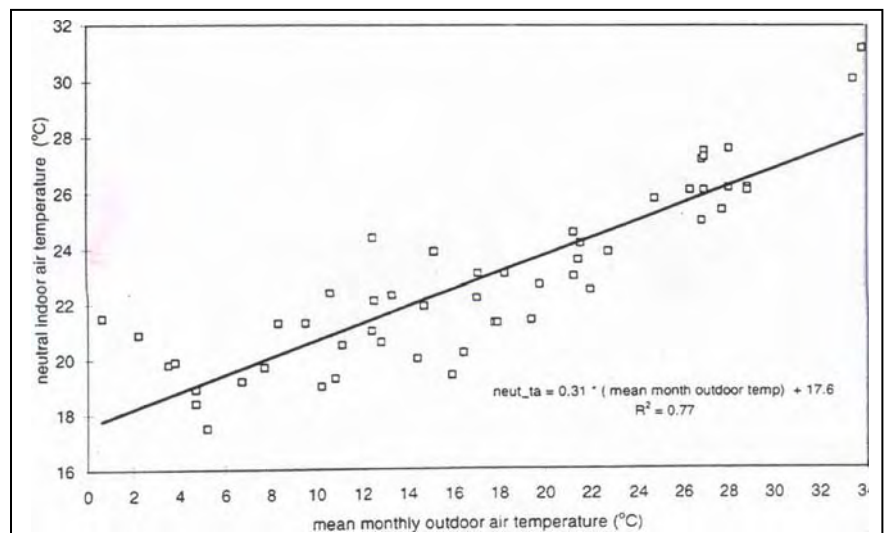

THERMAL COMFORT

Fig.26 Correlation of indoor neutrality with monthly mean outdoor temperature

Based on the study of Griffiths (1990) of European passive buildings the regression becomes practically the same as Humphreys:

$$T_n = 12.1 + 0.534 \cdot T_m$$

In a more recent study in Pakistan Nicol and Roaf (1996) found:

$$T_n = 17 + 0.38 \cdot T_m \quad (r=0.975) \quad \dots 3.5)$$

These are neutrality temperatures for people at sedentary work, in their normal environment, wearing the clothing of their choice and are valid between 18 and 30 °C. The comfort limits were then taken as $T_n \pm 2$ K.

The range in preferences could not be explained by metabolic activity or clothing, but the linear regression became exponential with a considerable loss in predictive power when similar analysis was conducted for buildings with active HVAC systems:

$$T_n = 23.9 + 0.295(T_m - 22) \cdot \exp\left[-\left(\frac{T_m - 22}{24\sqrt{2}}\right)^2\right] \quad (r=0.72) \quad \dots 3.6)$$

3.1.2 An adaptive model of comfort

These apparent inconsistencies with thermophysiological predictions led Auliciems (1981) to formulate an adaptive model of thermoregulation within which thermal preference is seen as the result of both physiological responses to immediate indoor parameters (i.e. those measured by the indices) and expectations based on "climato-cultural" determinants, i.e. past experiences (see Fig.27).

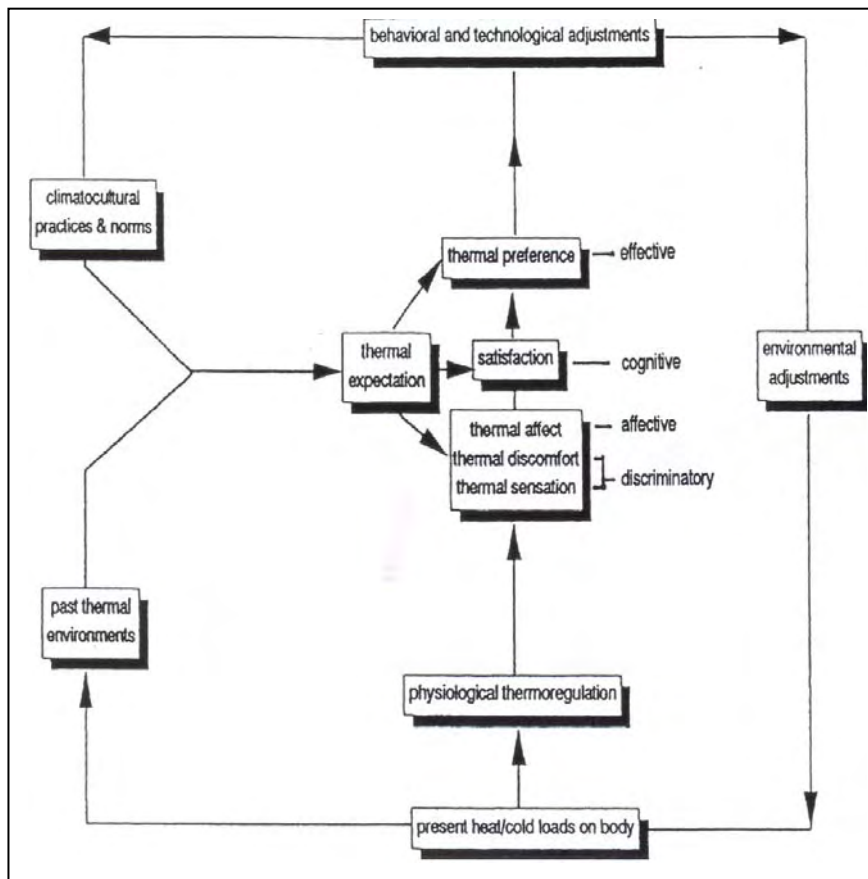

Fig.27 The psycho-physiological model of thermal perception: the adaptive model

THERMAL COMFORT

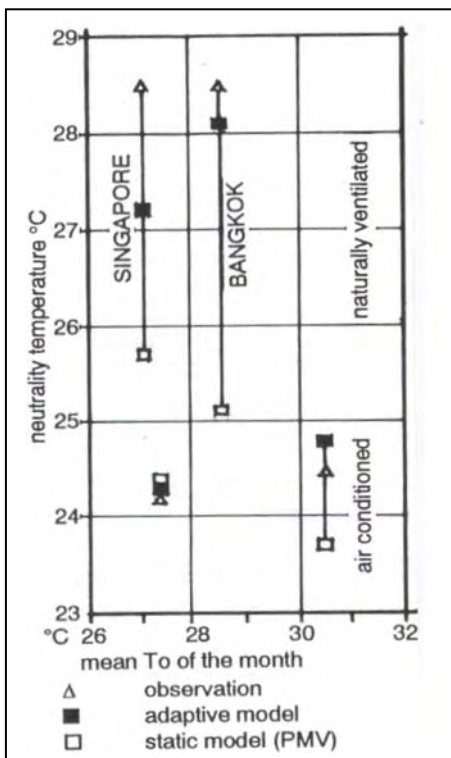

Fig.28 Neutralities predicted and compared with results of field experiments

The adaptive model subsequently has seen considerable investigation and verification in various locations. These include Melbourne, Brisbane and Darwin¹, San Francisco Bay Area², Bangkok³, Singapore⁴ and Townsville⁵ (as well as the studies mentioned in sections 2.6 and 3.1.1). Following a variety of recent theoretical discussions⁶ it has become evident that the notion of a constant or static optimum is no longer an acceptable hypothesis.

The comparison in Fig.28 shows very different responses by people at the same location, but in (a) air conditioned and (b) naturally ventilated buildings. The observed results are even higher than the adaptive model predictions.

In the language of systems theory, outdoor climate acts as negative feedback which attracts the thermal perceptual system's set point, thereby damping load error (dissatisfaction or discomfort) within the behavioural thermoregulatory system.

In the parlance of the impact models (Kates 1985), the adaptive model argues that involuntary behavioural responses are not restricted to second order impacts, but also refer to a preferred acceptance of some level of first order impacts, as modified by the thermal expectation feedback from third order impacts.

The implications of the adaptive model for thermal design of buildings are significant and are further discussed in part 4.

In a recent and major report to ASHRAE, de Dear, Brager and Cooper (1997) have exhaustively analysed all research reports from both naturally ventilated and HVAC controlled buildings, concluding that while a mechanistic model of heat transfer may well describe the responses of people within closely controlled thermal environments, it is "... inapplicable to naturally ventilated premises because it only partially accounts for processes of thermal adaptation to indoor climate."

The recommendations, as well as the updated ASHRAE RP-884 thermal comfort database are available on the internet at the following address:

¹ de Dear, R J (1985): *Perceptual and adaptational bases for the management of indoor climate*. PhD thesis, Uni.of Queensland

de Dear, R J and Auliciems, A (1985): A validation of the predicted mean vote model of thermal comfort in six Australian field studies. *ASHRAE Trans.* 91:452-468

² Schiller, G E, Arens, A, Bauman, F, Fountain, M and Docherty, T (1988): A field study of thermal environments and comfort in office buildings. *ASHRAE Trans.* 94:280-308

Schiller, G E (1990): A comparison of measured and predicted comfort in office buildings. *ASHRAE Trans.* 96:609-622

³ Busch, J F (1990): Thermal responses to the Thai office environment. *ASHRAE Trans.* 96:859-872

⁴ de Dear, R J, Leow, K G and Ameen, A (1991): Thermal comfort in the humid tropics. parts 1 and 2. *ASHRAE Trans.* 97(1):874-879 and 880-886

⁵ de Dear, R J and Fountain, M E (1994): Field experiments on occupant comfort and office thermal environments in a hot-humid climate. *ASHRAE Trans.* 100:457-475

⁶ de Dear, R J (1994): Outdoor climatic influences on thermal requirements indoors. In N.A.Oseland and M.A.Humphreys (eds) *Thermal Comfort: Past, Present and Future*. Garston U.K., Building Research Establishment, 106-132.

- also: Nicol, F, Humphreys, M, Sykes, O and Roaf, S (eds) 1995. *Standards for Thermal Comfort - Indoor Air Temperature Standards for the 21st Century*, Chapman and Hall, London.

- Auliciems, A and de Dear, R (forthcoming) *Thermal adaptation and variable indoor climate control* in Auliciems, A ed.

THERMAL COMFORT

http://atmos.es.mq.edu.au/~rdedear/ashrae_rp884_home.html

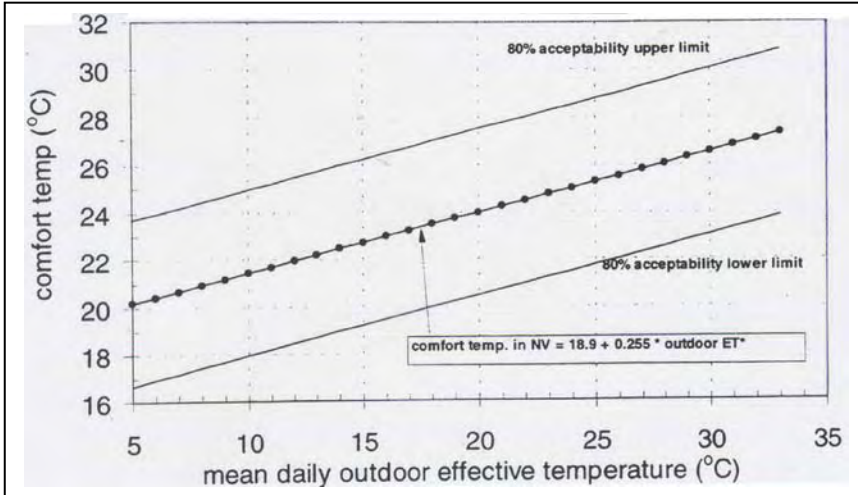

Fig.29 Correlations from ASHRAE RP-884 and 80% acceptability limits (from de Dear, Brager & Cooper, 1997)

Here the limits are taken as $T_n \pm 3.5$ K (i.e. a zone width of 7 K). For 90% acceptability these should be at $T_n \pm 2.5$ K (a width of 5 K).

In terms of outdoor ET^* (average) the most appropriate regression becomes:

$$T_n = 18.9 + 0.255 ET^* \quad \dots 3.6$$

for naturally ventilated (free running) buildings. The regression and limits of acceptability are shown in Fig.29.

For all buildings the regression equation is

$$T_n = 20.9 + 0.16 ET^*$$

and for mechanically heated or cooled buildings (where occupants are accustomed to a narrow range of artificially maintained conditions):

$$T_n = 21.5 + 0.11 ET^* \quad \dots 3.7$$

Note that the coefficients of ET^* are lower than in eqs. 3.2 - 3.4, but there DBT was used, whilst here ET^* , which allows for humidity effects.

In summary it can be concluded that people’s preferences are the result of both indoor and outdoor factors. Where choice is not limited by enforced constant indoor climate, such as that provided by centrally controlled air conditioning, the equations of the type 3.1 - 3.4, particularly eq.3.6, provide most appropriate criteria for design.

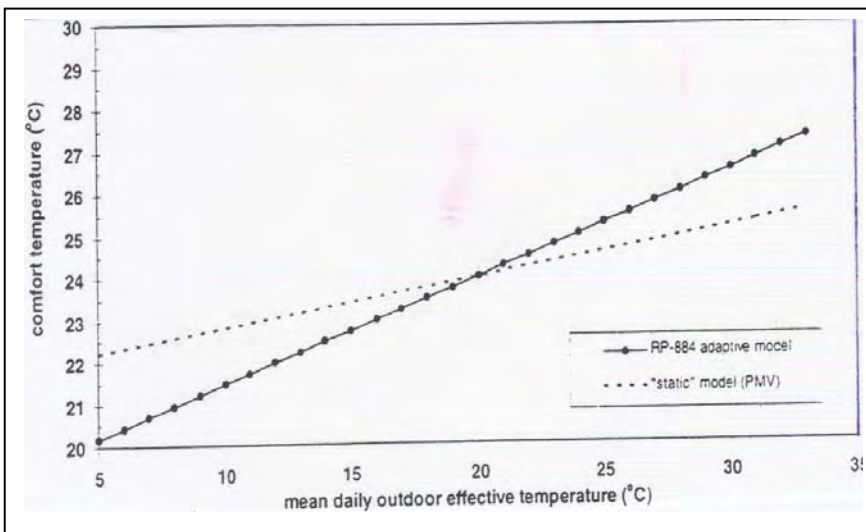

Fig.30 Comparison of neutrality temperatures predicted by eq.3.6 and by the PMV model, for naturally ventilated buildings (from de Dear, Brager & Cooper, 1997)

3.1.3 Acclimatization

Acclimatization (including habituation) is a complex set of physiological and psychological readjustments that take place when the organism is exposed to stress. This exposure acts to reset organic and cellular thresholds and rates of functioning by cardiovascular, pulmonary, endocrinal, digestive and nervous systems.

The manifestations of heat acclimatization include the increase of blood volume which increases the effectiveness of vasodilation, an enhanced efficiency of heat loss by sweat, both in terms of volumes and composition, and in accord with adaptation theory, a readjustment of temperature preference towards the stress stimulus.

The tangible results include decreased sensations of discomfort, improved work performance and in general an increased well-being. Acclimatization probably begins to occur within days of exposure to the stimulus, but in general it is a prolonged seasonal process where its full attainment results from everyday thermal experiences. Acclimatization is speeded up in people whose work is sufficiently vigorous to elevate metabolic heat production, which increases stress, thus accelerates adaptation.

Although considerable field research is still necessary, it would seem obvious that in everyday life, acclimatization frequently takes place through people's recreational activities in outdoor environments. While escape from air conditioning may increase such outdoor exposure, such avoidance may become a stress response in itself, and one that is not likely to lead to vigorous activities.

It is worth noting that already in 1958 Macfarlane* observed that coastal and inland people in Australia have different thermal preferences: the former have a lower temperature limit, but find higher humidities acceptable and vice-versa. There is also a difference between people of indoor occupations and those used to outdoor life. The latter find a broader range of conditions quite acceptable (Fig.31).

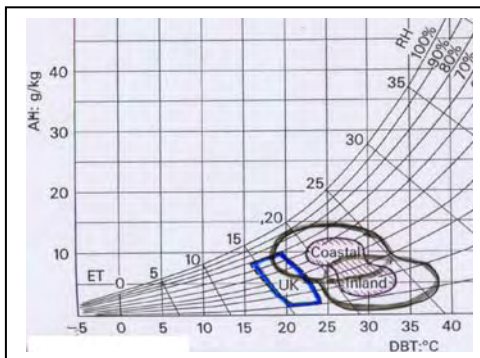

Fig.31 Comfort zones defined in 1958 by Macfarlane for Australian coastal and inland people (with extension for people used to outdoor work) compared with a comfort zone suggested for the UK

TABLE 6 Human adaptation strategies in response to thermal stimuli

- i. physiological adjustments, ranging from minor vasomotor to major sweating and metabolic responses
- ii. acclimatization (including habituation) of both physiological and psychological mechanisms by periodic exposure to thermal stimulus
- iii. food energy intake and dietary alterations
- iv. metabolic alterations in scheduling of activities, selection and curtailment of particular tasks or their sequencing
- v. migration, either temporary or permanent avoidance of particular stress conditions
- vi. clothing and building fabric interposition between the source of stress and the organism
- vii. external energy generation for space heating and cooling

For voluntary exposure to outdoor variability, indoor conditions need to be harmonious with those outdoors. That is, both satisfaction and opportunity for acquiring and maintaining acclimatization is likely to be enhanced when there is inducement for exposure to natural variability in atmospheric stimuli, and when people are free to choose between the higher level strategies of thermoregulatory adaptation. (iii to vii in Table 6).

THERMAL COMFORT

* Macfarlane, W V (1958): Thermal comfort zones. *Arch. Science Review*, 1(1):1-14, November

3.2 Consequences of discomfort

(The following section is largely based on a review by Auliciems in Thompson, R D & Perry, A eds. *Applied climatology*, eds. Routledge 1997)

3.2.1 Discomfort, behaviour and health

Thermal discomfort is not simply an unpleasant subjective sensation resulting from stress at a particular moment in time. There are cumulative effects, that either become translated into physiological response, or compensated in behavioural, or in the more extreme, adverse health effects. Conceptually, with our present state of knowledge, the relationships between comfort, behaviour and health can be envisaged as those in Fig.32

Within the area of human performance, there is some evidence to suggest that moderate thermal stress may actually lead to improved performances in schools and within factories with heat acclimatized workers, but in general, exposure to discomfort leads to loss of capacities for physical and mental work. This has been observed in tasks of vigilance, motor coordination and dexterity and ability or perhaps willingness to concentrate.

Changes in more complex human behavioural patterns, in association with short term temperature and weather variability, also have become documented. This included moods, traffic accidents, prison order and street riots, sexual aggression, and domestic violence.

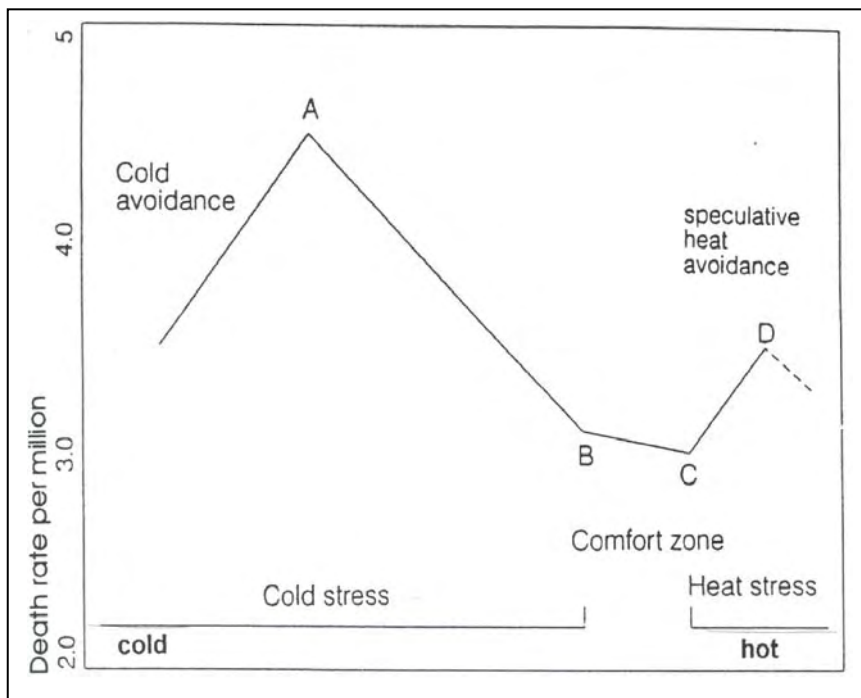

Fig.32 Postulated general relationship between mortality and temperature

The narrow comfort zone is bounded by stress zones on either side. At the extremes (in prosperous societies) the stress can be avoided: the death rates fall. From point B cold-related mortality increases, reaching its maximum at point A. From the maximum comfort (C) death rate increases with increasing heat stress to point D. X-axis: non-specified cold - hot continuum. Y-axis: approximation of death rates per million.

The direct causes for such changes in behavioural patterns are not always obvious and law enforcement officials readily point out the likely connection of antisocial behaviour to drug (including alcohol) abuses, which in themselves may be equally influenced by atmospheric parameters. While the results of the behavioural studies represent statistical associations only, the common trend indicates that antisocial behaviour is a function of environmental warmth, especially elevations of temperature above likely comfort ranges.

3.2.2 Atmospheric impacts on morbidity and mortality

Beyond behavioural disfunction, exposure to environments that repeatedly demand the more extreme responses, may prove to be damaging to human health, either directly or indirectly, or by debilitation of capabilities in the resistance to microorganism infection. In general seasonal increases in morbidity (sickness) and mortality (death rates) may be expected in human populations, especially in the elderly, poor and very young, when the stress risk is unexpected and sudden.

Amongst the most notable direct effects are the impacts of the passage of mid-latitude low and high pressure "weather phases" and of heat and cold upon the impaired or diseased thermoregulatory systems, which may result in cardio-vascular, cerebrovascular, respiratory, endocrinal, renal, rheumatic and consumptive diseases.

Whatever the method of describing the atmospheric condition, not surprisingly, the relationship between atmospheric factors and mortality has received even more attention. Over the past two decades, analysis has been carried out in many locations both for

- a) synoptic time series, and
- b) aggregated meteorological data.

Because of its dominance in the categories of death causes, and its thermoregulatory connotations, particular attention has been paid to death resulting from heart diseases.

The common observation in these studies is that death rates are elevated by both the thermal extremes, the response being in part relative to the nature of the certified cause of death. Most affected appear to be those related to the cardiovascular system and particularly notable are the differences in temperature thresholds at which death rates accelerate. These vary according to prevailing warmth of locations, and may be related to particular thermoregulatory thresholds (see Fig. 32).

Direct causation of ill health, as in the case of morbidity and behavioural effects, is far from self evident. Impacts may result from complex interactions at several levels with complicated feedbacks and controls, any of which may be affected by atmospheric factors with different weightings within individual parameters. To attribute morbidity and mortality to a specific parameter such as thermal stress, would be erroneous, and the phenomena need to be treated as part of complex biological-environmental interactions.

3.3 Comfort management systems

Human well being cannot simply be ascribed to the thermal environment in isolation from the other determinants of indoor atmospheric quality. Thus health, behaviour and productivity must to be related to the total work environment: comfort specifications need to be extended beyond simple thermal considerations.

Physiologically and psychologically well adapted people are likely to be those achieving an effective balance between the gaining of maximum acclimatization and normally residing within comfortable environments of their own choosing. That is, sensible designs would be those providing amenities and environments to encourage physical exercise with adequate exposure to thermal stimulus, but otherwise provide freedom from thermal stress during everyday work and rest periods.

Adopting approaches that focus on adaptability, especially acclimatization, increased reliance of clothing variation, and less reliance on active energy utilization, would promote a more harmonious synchronisation between the psycho-physiological functions of people and the natural environment.

The use of variable indoor comfort concepts provides increased scope for natural alterations of clothing and would reduce the average temperature difference between indoors and outdoors by about a third of a degree per degree of gradient. Such a reduction would imply a directly proportional 30% reduction in the need for active energy utilisation for space heating and cooling, without reduction in comfort, but probably with considerable improvement in ambient air quality and human health.

Neglecting at this time the educational problem of how such change can be instituted within free societies, it seems desirable that for populations already residing in buildings with close climate controls, a programme of deregulation could be instituted by allowing a gradual but progressively increasing indoor temperature drift towards those of outdoors. Depending upon available data and the type of building, the general target indoor level of warmth could be determined by empirical relationships such as those in equations 3.2 to 3.6 (see also Fig.33).

For example, in old buildings, providing that adequate outdoor temperature information exists, eq. 3.3 and eq. 3.6 would be preferable: in new buildings eq. 3.2 or 3.4 would be appropriate. With further verification of short term weather effects on indoor comfort, other equations could be established and employed depending upon the facility or building technology.

During the past decades, there have been considerable advances in architectural science principles based on human requirements and "passive" systems of energy utilization, "smart (or 'intelligent') building" designs and microprocessor developments. Innovative cybernetic approaches have been developed for the provision of environments for individual need and specialist tasks. Indoor environments can be made to respond to dynamic diurnal or seasonal changes within the outdoor atmosphere.

Perhaps the simplest approach is to adjust again the already versatile thermostat, already variously modified to anticipate changes in heat flows to and from the outdoor, to setback to reduce levels of heating and cooling at specified times, and in general to achieve an increased precision in operations.

THERMAL COMFORT

What needs to be further altered, either by designated chip or suitable interactive program is its “stat” functions to dynamic ones (for discussion of this thermo-mobile, or more simply *thermobile* concept and design see Auliciems 1984).

Apart from utilising innovative building designs and individual control capacities, there is reason to reappraise the passive energy technologies of traditional designs that, in conjunction with lifestyles to suit particular climatic rhythms, have well coped with thermal inclemency. Here, in the main, indoor thermal regulation has depended on natural ventilation, shading, sizes and positions of openings, orientation materials, and thermal mass; the very elements essential for the enhancement of outdoor exposure and acclimatization.

There exists more than just *prima facie* evidence to suggest that, at least in some instances, a return to such microclimate control methods may be environmentally and socially the most appropriate approach in many locations. The alternative of a smart building - cybernetic approach based on adaptation rather than some current mechanistic close control “zoo keeper” method of microclimate management, may produce five major groups of benefits:

1. enhancement of overall comfort levels, and increase of individual capacity for microclimate adjustment
2. reduction in the incidence of the “sick building syndrome”
3. encouragement of adjustment by individual clothing changes and the wearing of ensembles that better reflect weather conditions outdoors
4. reduction of outdoor-indoor temperature gradients and thus the thermal “shock” of moving from one environment to another, promotion of outdoor activities and improvement in “physical fitness” and the facility for seasonal acclimatization
5. reduction in the need for HVAC technologies and fossil energy requirements.

THERMAL COMFORT

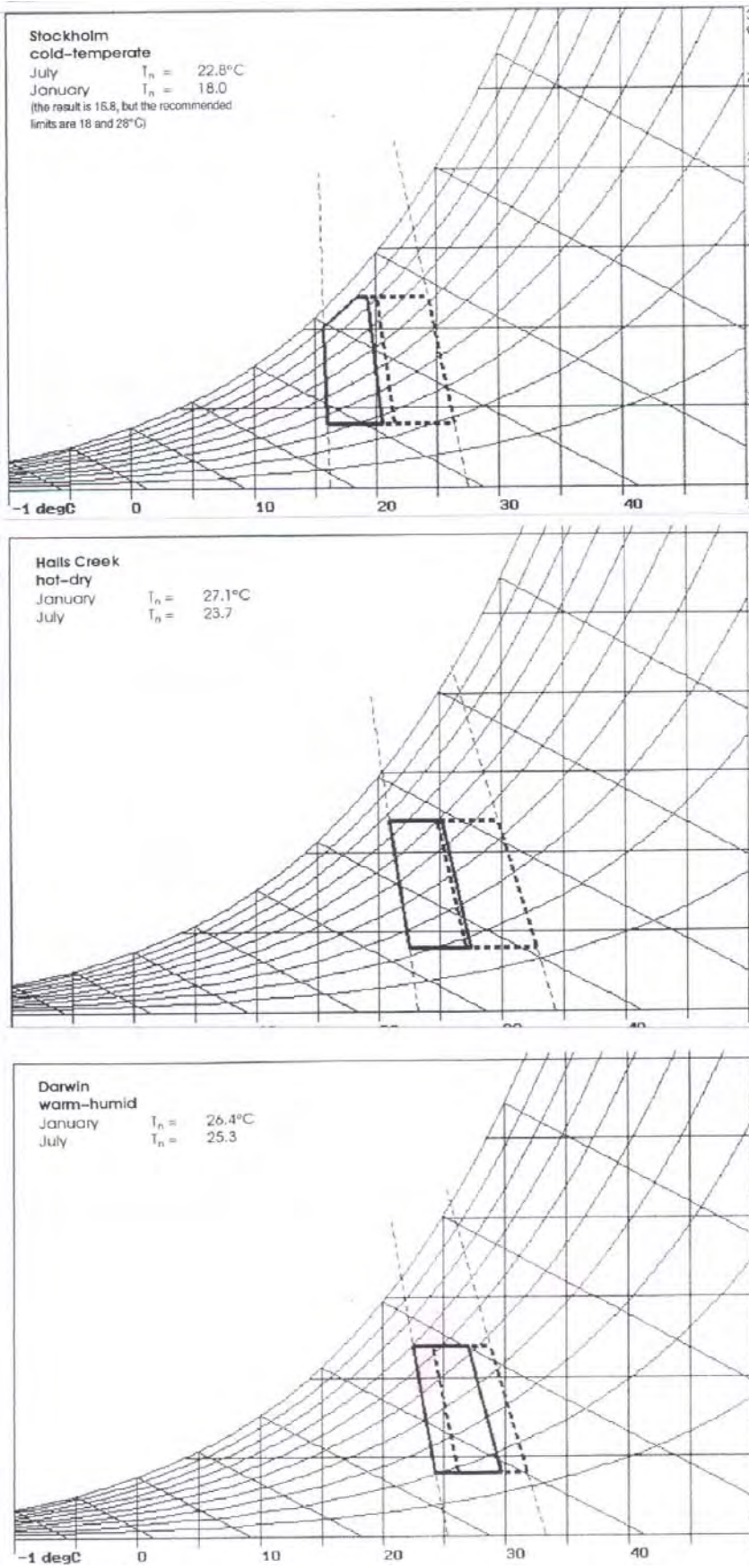

Fig.33 Three climates, January and July comfort zones based on eq. 3.3
Note the shift towards warmer temperatures and the increasing overlap

THERMAL COMFORT

for warmer and more humid climates (less seasonal variation)

PART 4 PRACTICE

4.1 The 'comfort zone'

Olgay was the first to outline the *comfort zone* in architectural terms, i.e. the range of environmental conditions within which the average person would feel comfortable. He did this in graphic form, with DBT on the vertical axis and RH on the horizontal. The aerofoil-shaped zone at the centre of this graph is the comfort zone. Fig.34 shows his original bioclimatic chart, together with its playful interpretation and Fig.35 is a chart converted to metric units and adjusted for warm climates.

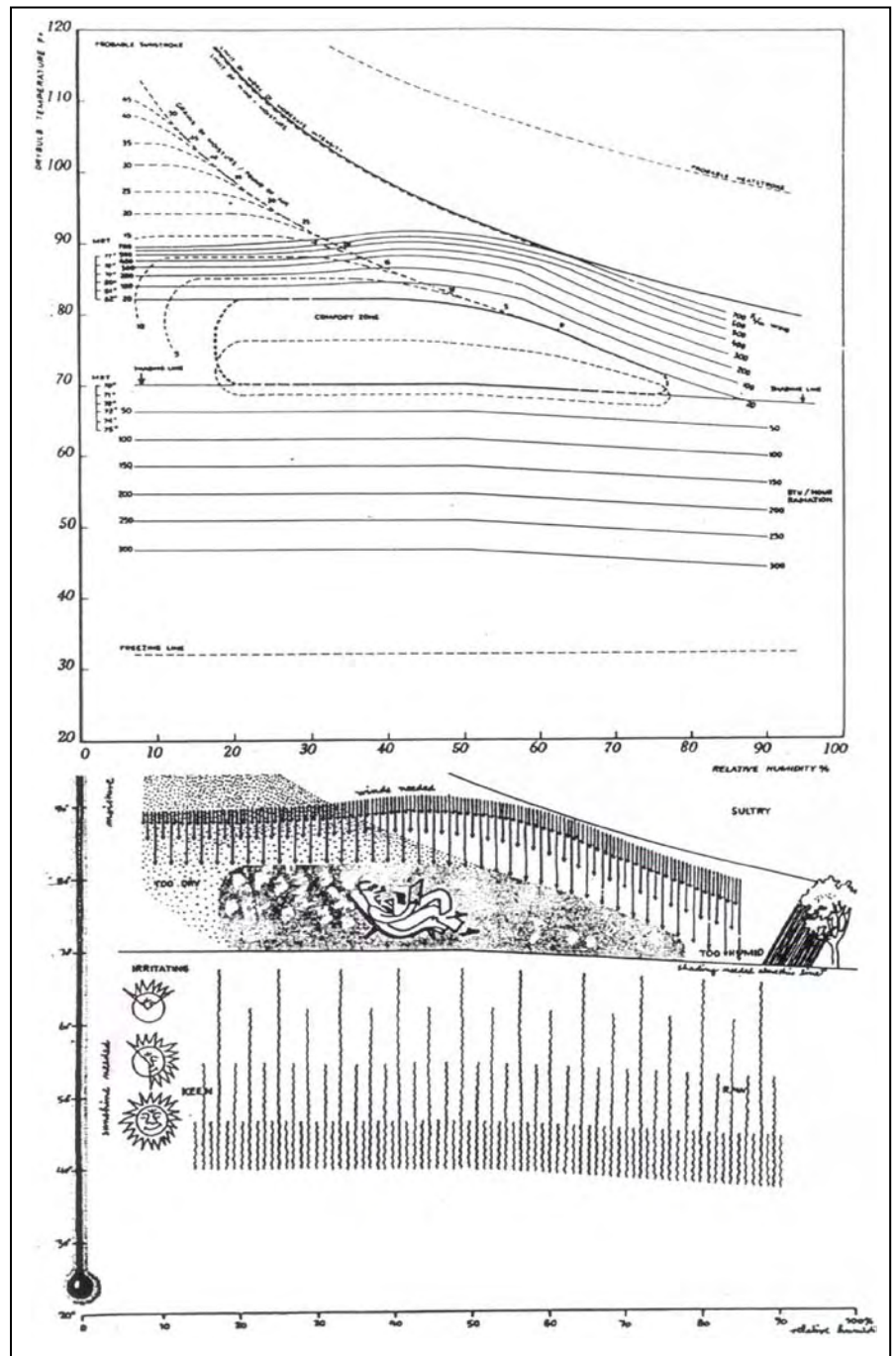

THERMAL COMFORT

Fig.34 Olgay's bioclimatic chart and its graphic interpretation
(to show the pattern, not necessarily the numbers, which are in imperial units)

He subsequently drew lines above the comfort zone, showing how air movement at different velocities could extend the upper boundary of the comfort zone (or: if the DBT is above the comfort limit, what air velocity would be required to restore comfort). Below the comfort zone a family of lines indicate various levels of radiation that would compensate for the lower than comfortable temperatures. This chart became quite popular amongst architects. Whilst the various single-figure indices would conceal the magnitude of individual variables, this chart allows the manipulation of these variables, showing the contribution of each separately. The prevailing climatic conditions can then be plotted on the same chart, which will allow a diagnosis of the climatic problem.

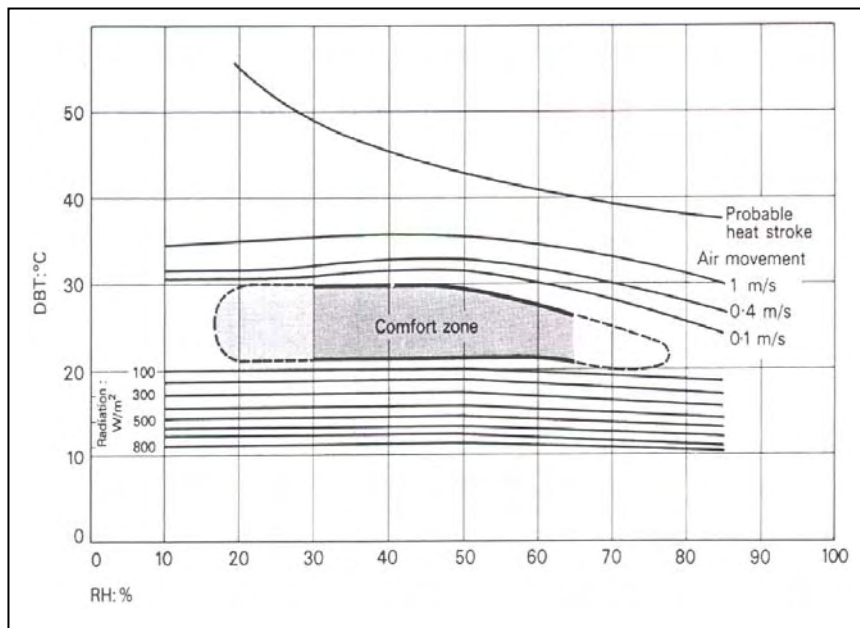

Fig.35 Metric version of the bioclimatic chart

Arens and his co-workers (1980) published a new version of this chart, revised according to the results of the J B Pierce two-node model of the thermoregulatory system (Fig.36). It is applicable for persons wearing 0.8 clo, with a metabolic rate of 1.3 met (75 W/m^2), which corresponds to light household work. The comfort zone boundaries were adopted from ASHRAE Standard 55-74R. An innovation is the use of the ERF (effective radiant field) concept for evaluating the effect of directional radiation. This is the expression of irradiance received by a person from the sun as well as diffuse and reflected radiation from all directions. MRT is still used for indoor conditions.

Yaglou (1923) was the first to use the psychrometric chart as a base for his 'equal comfort lines' (p.22) and many subsequent researchers followed his example. Arens et al. (1980) also presented their bioclimatic chart in this format (Fig.37) as well as with the rectangular coordinate diagram. The comfort zone is the trapezoidal area at the centre.

ASHRAE also used the psychrometric chart for the definition of the comfort zone since 1966, but their definition of the boundaries went through a number of alterations (Fig.38) as research progressed and opinions changed. The 1966 version gave the temperature limits by DBT (vertical) lines and the humidity limits by two RH curves. In 1974 the side boundaries

THERMAL COMFORT

changed to ET* lines and the humidity boundaries were defined in terms of vapour pressure (or the corresponding AH or RH (horizontal) lines).

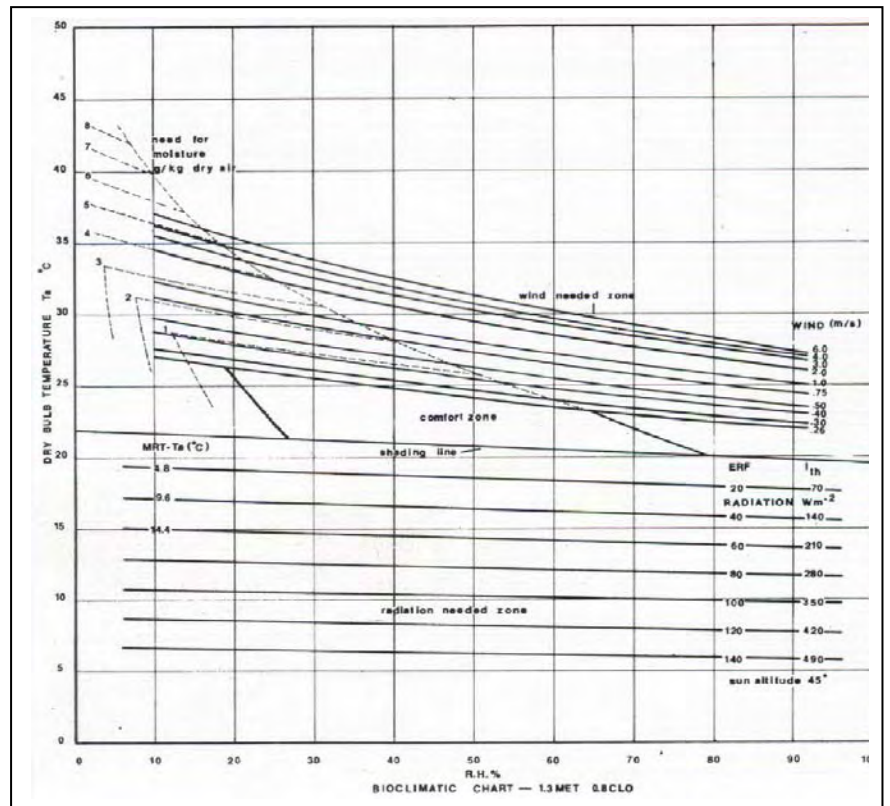

Fig.36 The bioclimatic chart revised by Arens et.al.

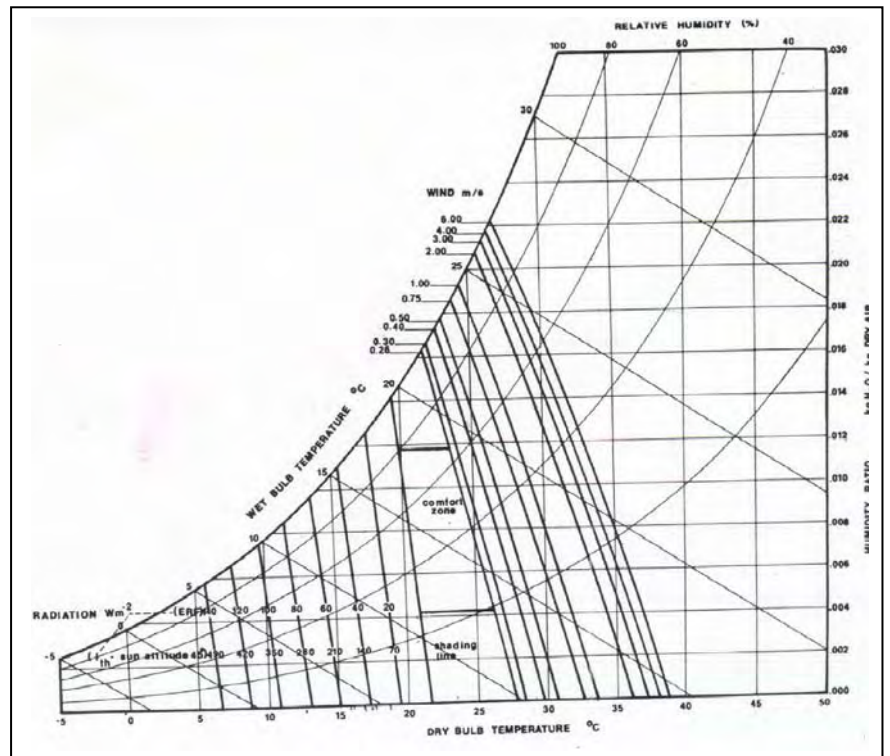

Fig.37 The psychrometric version of the above chart

THERMAL COMFORT

The argument for this was that the vapour pressure at the skin hardly changes (within comfort limits), thus the main determinant of evaporation (thus of the cooling effect), is the ambient vapour pressure.

1981 was the first instance when summer and winter comfort were distinguished. Humidity limits remained the same. In the 1992 revision the temperature boundaries and the lower humidity limit remained the same, but the for the upper humidity limit the chart reverted to the 60% RH curve. The rationale behind this was that higher humidities, even at lower temperatures may have non-thermal ill-effects. In 1995 the side and lower boundaries again remained the same, but the upper humidity limits were changed to two WBT lines. The argument here was that this is a thermal standard, therefore other, non-thermal effects should not be included (but it is also less restrictive on evaporative coolers).

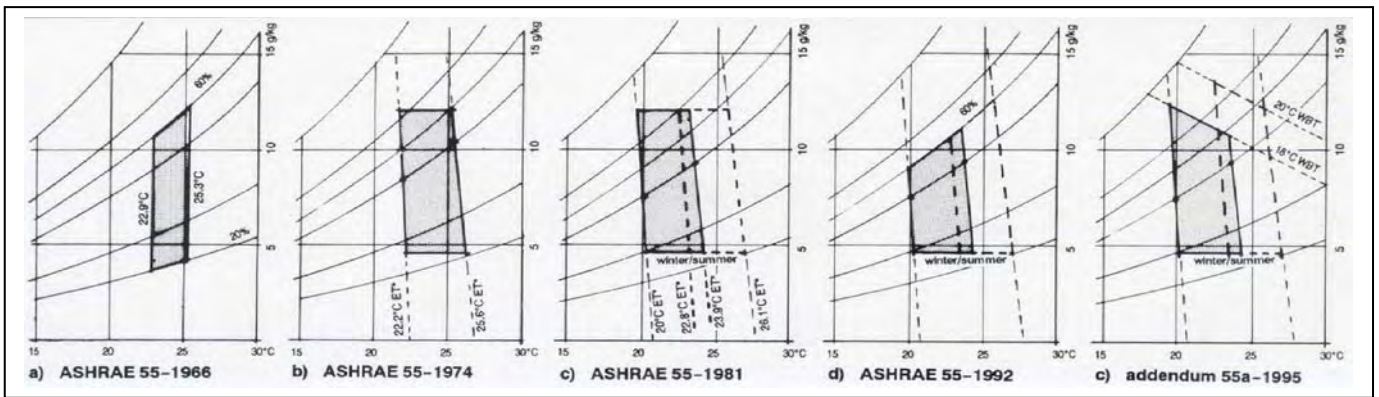
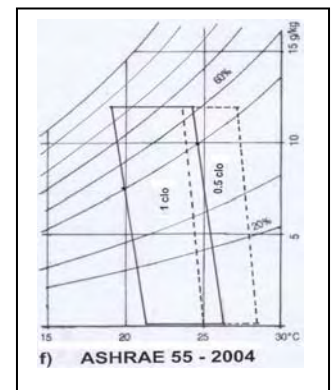

Fig.38 Historical development of the ASHRAE comfort zone

The upper humidity limit is still a contentious issue and several research projects are currently aimed at this question. It is suggested that - until there is a convincing reason to change this - the rationally based 1981 upper humidity limit of 12 g/kg (1.9 kPa vapour pressure) is used.

It is interesting to note that the latest version of the ASHRAE Code (Standard 55-2004) reverts to the 12 g/kg upper limit of humidity, and that it abolishes the lower limit (Fig.38 f). Now there is no lower limit. It has been suggested that this lower limit (4 g/kg) had been imposed for non-thermal reasons, so it should not be included in a thermal comfort standard. These reasons were excessive drying out of the skin, and especially of the mucous membranes. The view we accept is that if the concern is human well-being, (whether it is labelled thermal comfort or just comfort in general) then such reasons justify the inclusion of lower limits.



The 1981 summer and winter zones are now replaced by 1 clo or 0.5 clo clothing insulation. This is justified by needing an "objective" reason, rather than a nebulous notion of 'acclimatisation'. Note that the upper limit of the 1 clo zone is somewhat higher than the old 'winter' zone, the 0.5 clo zone is about the same width as the 'summer' zone was, but slightly higher temperatures are allowed.

For these reasons we suggest that there is no need to revise our recommended working method given in the next section.

THERMAL COMFORT

4.2 Recommended working method

If a design is to be carried out for a project in an unfamiliar location or for a particular building type for the first time, it is strongly advisable to define the target: the kind of indoor environmental conditions to be created.

It is essential to have climatic data which includes at least the monthly mean minimum (T_{\min}), and mean maximum (T_{\max}) temperatures. The following exercise should then be carried out for (at least) the coldest and the warmest month: usually January and July.

For both months take the following steps:

1. find the mean temperature as $T_m = (T_{\min} + T_{\max})/2$
e.g. for Phoenix (AZ), Jan: $T_m = (4+18)/2 = 11$
Jul: $T_m = (25+40)/2 = 32.5$
2. find the thermal neutrality (the mean value for the month), substituting this T_m value into eq. 3.4:

$$T_n = 17.8 + 0.31 \bullet T_m$$

in this case $17.8 + 0.31 \bullet 11 = 21.2^\circ\text{C}$

and $17.8 + 0.31 \bullet 32.5 = 27.8$ respectively.

Mark these on the 50% RH curve of Fig.40

(in practice a photocopy of Fig.39 may be used)

3. the comfort zone can then be taken as $T_n - 2.5$ to $T_n + 2.5^\circ\text{C}$ (i.e. 5 K wide) for 90% acceptability
here Jan: $18.7 - 23.7^\circ\text{C}$ and Jul: $25.4 - 30.4^\circ\text{C}$
(these are marked at the 50% RH curve)

The corresponding SET lines give the side boundaries of the comfort zones. The humidity limits are taken as 4 and 12 g/kg respectively, as per Fig.38/C

and, the range can be extended

$T_n - 3.5$ to $T_n + 3.5^\circ\text{C}$ (i.e. 7 K wide) if 80% acceptability is adequate;

here Jan: $17.7 - 24.7^\circ\text{C}$ and Jul: $24.4 - 31.4^\circ\text{C}$

The horizontal scale of Figs.39 and 40 is in $^\circ\text{C}$, OT (operative temperature). If MRT = DBT and average wind velocity is negligible, then DBT can be used for OT, otherwise adjustments must be made (see section 2.4.4, p.25).

The above is applicable to naturally ventilated buildings. For buildings fully heated or air conditioned, for occupants used to narrowly controlled conditions, equation 3.7 may be applicable:

$$T_n = 21.5 + 0.11 T_m$$

and the limits of the comfort zone are

$T_n - 1.2$ to $T_n + 1.2^\circ\text{C}$ (i.e. 2.4 K wide) for 90% acceptability

and

$T_n - 2$ to $T_n + 2^\circ\text{C}$ (i.e. 4 K wide) for 80% acceptability

Otherwise the methodology is the same as above.

The design temperatures and comfort limits thus established are valid for activity levels of 1.1 - 1.4 met and for people wearing about 0.7 clo in summer and 0.9 clo in winter. Adjustments can be made:

- each met increase (up to 3 met) : reduce temperature by 2.5 K
- each 0.1 clo added : reduce temperature by 0.6 K

(for various met and clo values see Table 1 (p.6) and Table 3 (p.9) respectively.)

THERMAL COMFORT

A graphic illustration of the above example: recommended comfort zones for Phoenix (AZ) is given in Fig.40)

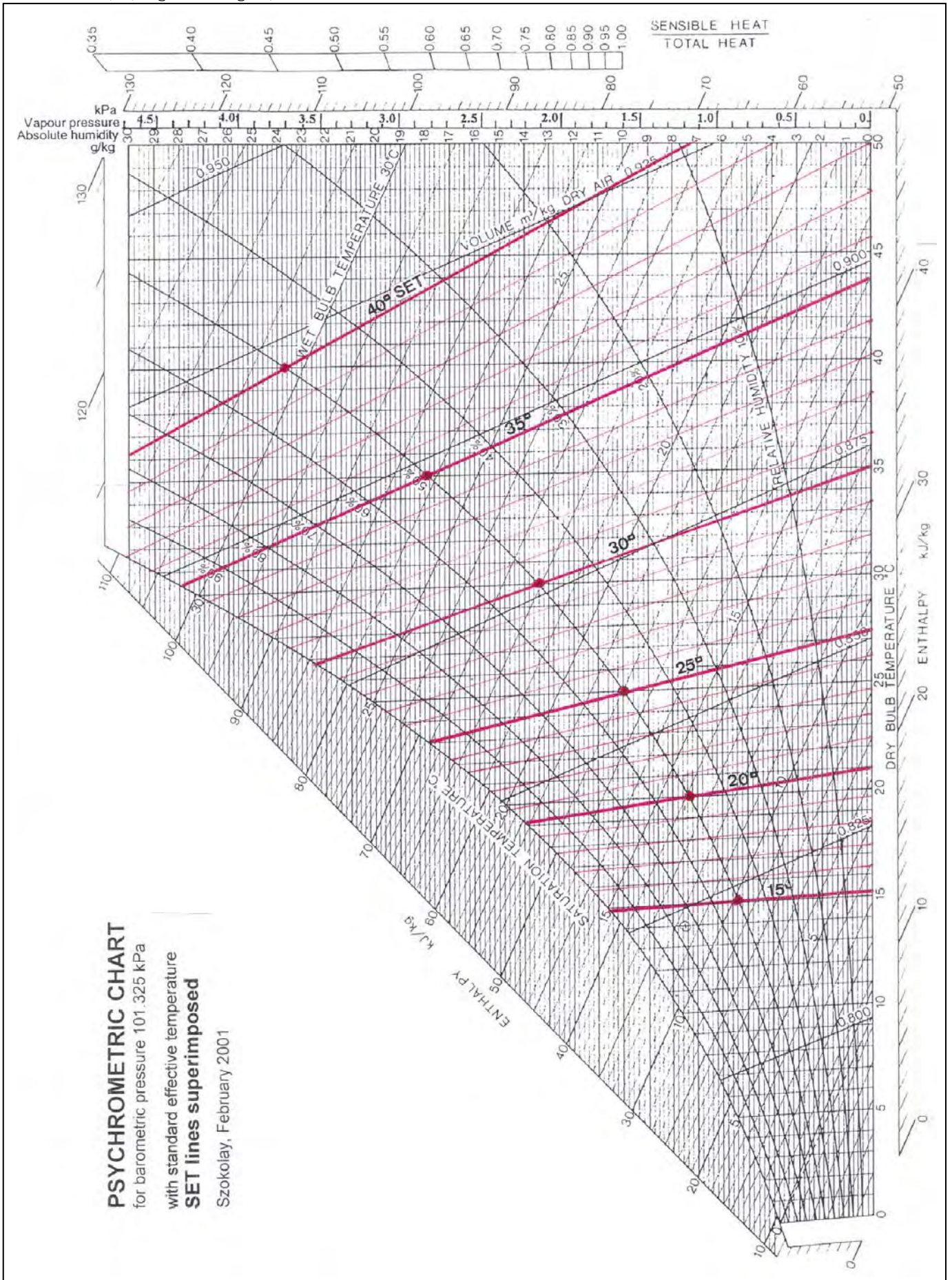

THERMAL COMFORT

Fig.39 Psychrometric chart with SET lines superimposed

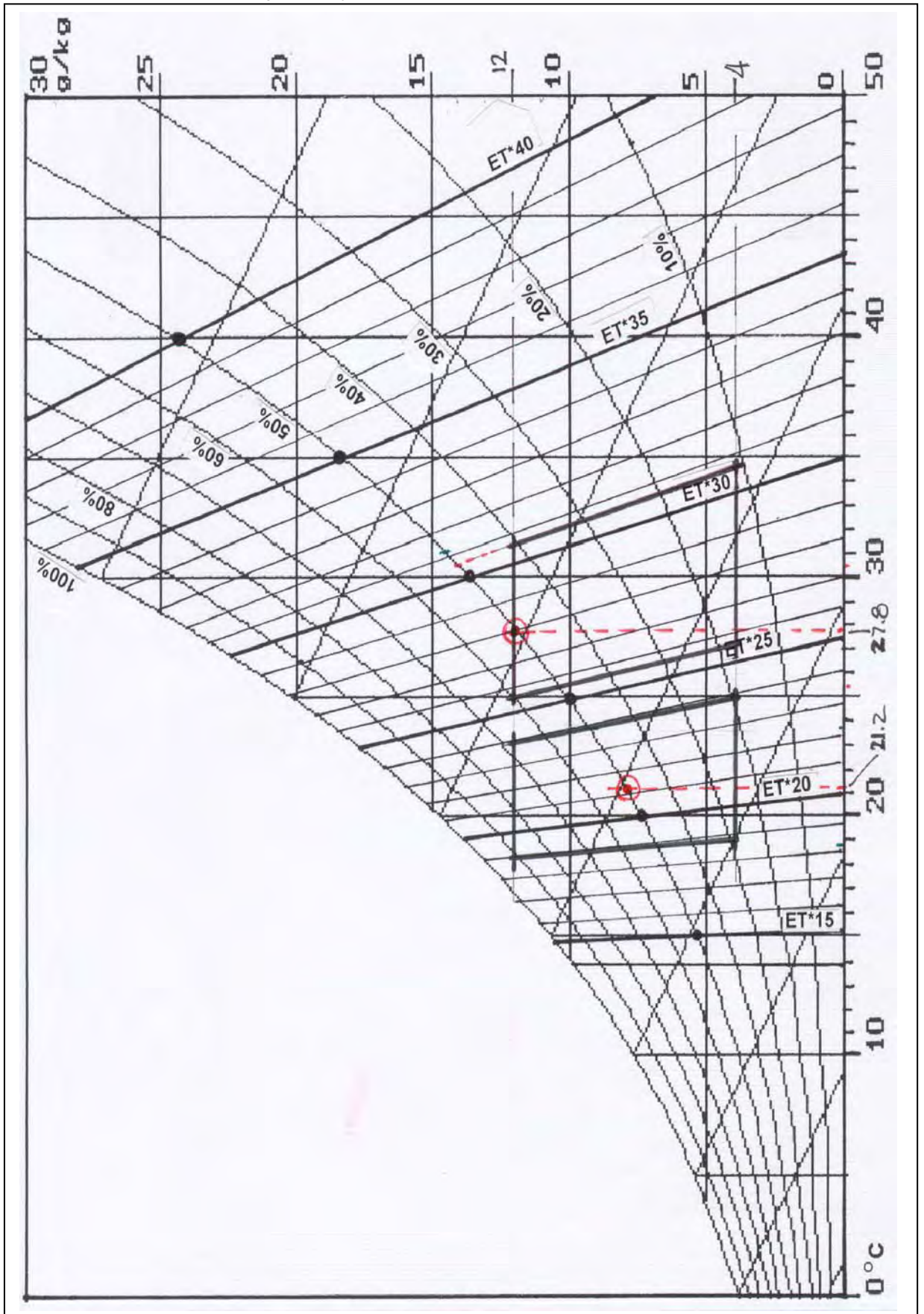

THERMAL COMFORT

Fig.40 A simplified psychrometric chart showing January and July comfort zones for Phoenix (AZ) based on eq. 3.4, to illustrate the method recommended in section 4.2.

The comfort zones are shown for 90% acceptability (5 K wide).

Conclusion

Irrespective of the strategies adopted, the results of calculations and graphic analyses must be mitigated by human intelligence and not slavishly accepted in a mechanistic way.

The rationale and economy of air cooling in latitudes within the tropics needs to be put under close scrutiny (as well as the now usual heating practices in higher latitudes). What is questioned here is not innovation in HVAC technologies nor air cooling when thermal stress is otherwise unavoidable in the workplace, but its uncritical and wasteful usage in large volumes and at times when other technologies or behavioural patterns are available.

In the larger sense, whatever may be the economic arguments in favour air conditioning developments, the proliferation of this technology is likely to increase the production of greenhouse gases (thus global warming), and lead to a progressive degeneration of thermoregulatory adaptability in people living in closely controlled environments. Should disruptions occur in their maintenance, as could take place with global warming, populations are likely to become increasingly susceptible to impairment in thermo-regulatory mechanisms, social behaviour, productivity and health.

While thermally comfortable indoor environments are taken for granted especially by urban dwellers, the increasing dependence on equable indoor warmth must also be examined in the light of the global need to conserve energy resources and reduce the emissions of greenhouse gases. It should be remembered that thermal comfort is remarkably expensive: in the latter part of the 20th century, globally it probably consumes about a quarter of all energy supplies.

Looking towards the future, with typical doubled CO₂ equivalent scenarios as generated by computerized GCMs (general circulation models), even with maximum acclimatization and energy efficient designs, achievement of homeostasis would be more difficult for some 20% of the world's population the whole year round, and heat stress would be an increased seasonal problem for another 65%. Increasing educational efforts designed to wean people away from unnecessary space heating, and especially air cooling seems must be an essential policy.

References Numerous references are listed in footnote form, where they are relevant to that page only, such as in the survey of thermal indices (part 2) and on p.47

- Arens, E, Zeren, L, Gonzales, R, Berglund, L and McNall, P E (1980): A new bioclimatic chart for environmental design. Proc. *Bldg Energy Managemt* conf. (ICBEM), Povo de Varzim. Pergamon
- ASHRAE (1985) *Handbook of Fundamentals*. Am.Soc.of Heat'g, Refrig. and Air-cond.Engrs. (SI edition)
- Auliciems, A (1981): Towards a psycho-physiological model of thermal perception, *Int J of Biometeorology*, 25:109-122
- Auliciems, A. (1983): Psycho-physiological criteria for global thermal zones of building design. *Int J Biometeorol.* 26 (Suppl.): 69-86.
- Auliciems, A (1984): Thermobile controls for human comfort. *Heat Vent Engr.* 58:31-34
- Bedford, T(1936): *Warmth factor in comfort at work*. Med Res C'l, Ind Health Res Board, Report No 76. HMSO
- Belding, H S & Hatch, T F (1956): Index for evaluating heat stress in terms of resulting physiological strains. *ASHRAE Trans.* 62:213-228
- Burton, A C (1935): Human calorimetry, average temperature of the tissues of the body. *J of Nutrition.* 9:261

THERMAL COMFORT

- CIBSE (1978): Guide, A1, *Environmental criteria for design*. The Chartered Institution of Building Services (Engineers)
- Danter, E (1974): Heat exchanges in a room and definition of room temperature. *Bldg. Serv. Engr.* 41:231-242
- de Dear, R.J. (1995): Thermal comfort in air-conditioned office buildings in the tropics. In Nicol, F., M Humphreys, O Sykes and S Roaf (eds) *Standards for thermal comfort: Indoor air temperature standards for the 21st century*. E & FN Spon - Chapman and Hall, London. pp.122-131.
- de Dear, R J, Brager, G and Cooper, D (1997): *Developing an adaptive model of thermal comfort and preference*. Final report, ASHRAE RP-884, March
- Drysdale, J W (1950): *Climate and the design of buildings: physiological study No.2*. Exper Bldg Stn, Sydney
- Du Bois, D & Du Bois, E F (1916): A formula to estimate approximate (body) surface area if weight and height are known. *Archives of Internal Medicine*, 17:863-871
- Fanger, P O (1982): *Thermal comfort*. Kreiger, Florida (original : Danish Technical Press, 1970)
- Gagge, A P (1936): The linearity criterion applied to partitional calorimetry. *Am J of Physiology*. 116:656-668
- Griffiths, I (1990): Thermal comfort studies in buildings with passive solar features. rep.to CEC ENS35 090 UK
- Grubich, V (1961): *Az időjárás és az ember* (Climate and man), Medicina, Budapest
- Givoni, B (1994): *Passive and low energy cooling of buildings*. Van Nostrand Reinhold, New York
- Haldane, J S (1905): Influence of high temperatures. *J. of Hygiene, Camb.* 5:494
- Heberden, W (1826): An account of the heat of July 1825, some remarks on sensible cold. *Phil. Trans.* 2:69
- Houghten, F C & Yaglou, C P (1923): Determination of comfort zone. *Trans. ASHVE*, 29:361
- Humphreys, M A (1975): Field Studies of Thermal Comfort Compared and Applied. *Building Research Establishment, Current Paper (76/75)*, U.K. Dept. of Environment.
- Humphreys, M A (1976): Comfortable indoor temperatures related to the outdoor air temperature. *Building Research Establishment (Note PD117/76)*, U.K. Dept. of Environment.
- Humphreys, M (1978): Outdoor temperatures and comfort indoors. *Bldg Res & Practice*. 6(2):92-105 also BRE Current Paper 53/78
- Humphreys, M A and Nicol, F (1996): Conflicting criteria for thermal sensation with the Fanger PMV equation. *CIBSE/ASHRAE joint national conference*, London
- Kates, R W (1985): The interaction between climate and society. In Kates, R.W., Ausubel, J., and Berberian, M. (eds) *Climate Impact Assessment: Studies of Interaction between Climate and Society*, pp3-36, Wiley, New York.
- Karyono, Tri H (1996): Thermal comfort in the tropical South-East Asia region. *Arch.Sc.Rev.* 39(3):135-139
- Lee, D H K (1980): Seventy-five years of searching for a heat index. *Env.Res.*, 22:331-356 (Academic Press)
- Macfarlane, W V (1958): Thermal comfort zones. *Arch. Science Review*, 1(1):1-14, November
- Macpherson, R K (1962): The assessment of the thermal environment: a review. *Brit J Ind Med*. 19:151-164
- McIntyre, D A (1980): *Indoor climate*. Applied Science Publishers, London
- Nicol, F and Roaf, S (1996): Pioneering new indoor temperature standards: the Pakistan project. *Energy and Buildings*, 23:169-174
- Olgay, V (1953): *Bioclimatic approach to architecture*. BRAB Conf Rept 5. Nat Bldg Res Council, Washington
- Olgay, V (1963): *Design with climate*. Princeton Uni. Press, Princeton, NJ.
- Smith, S E (1955): *Indices of heat stress*. Med Res Council, Special Report 29, London
- Socrates - quoted by Xenophon (cca. 400 BC): *Memorabilia*. transl. E C Marchant (1923), (book III, chap. 8, section 9) Loeb Classics, Heinemann, London
- Szokolay, S V (1980): *Environmental science handbook*. Longman/Construction Press, Wiley/Halsted Press
- Szokolay, S V (1991): Heating and cooling of buildings, chap.20. in H J Cowan (ed): *Handbook of Architectural Technology*. Van Nostrand Reinhold, New York.
- Thom, E C (1959): The discomfort index (THI), *Weatherwise*, April
- Thompson, R D and Perry, A (eds.) (1997): *Applied climatology*. (esp. ch.12: Comfort, clothing and health by Auliciems, A), Routledge
- Vernon, H M & Warner, C G (1932): The influence of humidity of the air on capacity of work at high temperatures, *J. of Hygiene, Camb.* 32:431
- Vitruvius, (1st C. BC): *The ten books of architecture*. transl. F Granger (1970), (esp. book I, chap. 4 & 6)
- Williamson, T J, Coldicutt, S and Riordan, P (1995): Comfort, preferences or design data, in *Standards for thermal comfort: Indoor air temperature standards for the 21st century*, eds. Nicol, F, Humphreys, M, Sykes, O and Roaf, S. E & F N Spon / Chapman & Hall, London. p.50-58

THERMAL COMFORT

Winslow, C E A, Herrington, L P & Gagge, A P (1937): Physiological reactions to environmental temperature. *Am.J. of Physiology*, 120:1-22

Woolard, D S (1981): The graphic scale of thermal sensation. *Arch.Sc.Rev.* 24(4):90-93

APPENDIX 1

A numerical example for the 'two-node model'

continued from p.18

Take a person engaged in sedentary work: $M = 100 \text{ W}$, wearing 0.65 clo
 Mechanical efficiency: $\eta = 0.2$, thus $M(1-\eta) = 100 \cdot 0.8 = 80 \text{ W}$

Assume $W_{rsw} = 0.2$
 $h_c = 3.3 \text{ W/m}^2\text{K}$
 $h = 8$

Environmental data: $t_a = 25^\circ\text{C}$
 $\text{RH} = 54\%$
 $p_{sk} = p_s \text{ at } 34^\circ\text{C} = 5.6 \text{ kPa}$
 $p_a = 1.7 \text{ kPa}$

$$E_{resp} = 0.0173 \cdot 100 (5.87 - 1.7) = 7.2 \text{ W}$$

$$C_{resp} = 0.0014 \cdot 100 (34 - 25) = 1.3$$

$$M_{sk} = 80 - 7.2 - 1.3 = 71.5 \text{ W}$$

$$F_{cl} = \frac{1}{1 + 0.155 \cdot 8 \cdot 0.65} = 0.554$$

$$F_{pcl} = \frac{1}{1 + 0.344 \cdot 3.3 \cdot 0.65} = 0.575$$

$$R + C = 8 \cdot (34 - 25) \cdot 0.554 = 39.9 \text{ W}$$

$$E_{max} = 16.7 \cdot 3.3 \cdot (5.6 - 1.7) \cdot 0.575 = 123.5 \text{ W}$$

$$E_{rsw} = 0.2 \cdot 123.5 = 24.7 \text{ W}$$

$$E_{diff} = 0.8 \cdot 0.06 \cdot 123.5 = 5.9 \text{ W}$$

$$E_{sk} = (0.06 + 0.94 \cdot 0.2) \cdot 123.5 = 30.6 \text{ W}$$

$$S = M_{sk} - (R+C) - E_{sk} =$$

$$S = 71.5 - 39.9 - 30.6 = \mathbf{1 \text{ W}}$$

or from the full thermal balance equation (eq.2.6):

$$S = 100 \cdot [0.8 - 0.0173 \cdot (5.87 - 1.7) - 0.0014 \cdot (34 - 25)]$$

$$- 16.7 \cdot 3.3 \cdot (5.6 - 1.7) \cdot 0.575 \cdot (0.06 + 0.94 \cdot 0.2) - 8 \cdot (34 - 25) \cdot 0.554$$

$$= \mathbf{1 \text{ W}}$$

(for thermal equilibrium S should be 0, so this 1 W may be a rounding error, or there is a storage component, indicating insufficient dissipation: the body would be warming)

THERMAL COMFORT

Index

for individual comfort indices see 'Contents' list on p.2

absolute humidity	8, 10, 12
acclimatization	8, 42, 49, 52
adaptation	3, 15, 45, 49, 52
adaptive model	46, 47
air	10
- movement	8, 14
- velocity	8, 14, 21, 23, 25-29, 31, 40
anemometer	14
behaviour (-al)	46, 47, 50, 51
bioclimatic chart	16, 55, 57
clothing	9, 26, 34
clo unit	9, 14, 23, 25, 36, 44
comfort	3, 5, 15, 16
- equation	16, 18, 42
- management	52
- scales	15
- zone	5, 29, 42, 55, 58
conduction	6
convection	6, 18, 19
correlations	45, 48
dehumidification	11
dew-point temperature	11, 12, 43
discomfort ('uncomfort')	36, 41, 42, 43, 50
dry bulb temperature	10, 21, 43
DuBois area	6, 17, 19, 25
ecosystem	3
enthalpy	11
evaporation	6, 7, 17-19, 34
factors of comfort	8
field studies	15, 45
globe thermometer	8, 21
goose pimples	7
greenhouse	62
homoeothermy (-ic)	6
humidity ratio	10, 12, 19
hygrometer	10, 12
metabolic rate	6, 16, 32-34, 37
metabolism	6, 21
met unit	6, 14
morbidity	51
mortality	51
new effective temperature	36-38
hygrometer	12
hyperthermia	7
hypothermia	7
psychrometer	12
psychrometry	10, 11
psychrometric chart	13
physiology (-ical)	3, 5, 6, 15
radiation	6, 8, 33, 34, 43
relative humidity	10, 12
saturation	10
shivering	7
skin temperature	6, 18, 19, 25, 37
static model	42, 47, 48
sustainability	3
sweat (-ing)	6, 8, 17, 31, 34, 49
thermal neutrality	45, 46, 48
- preferences	15, 45, 46, 48, 49
- strain	30, 33, 42
- stress	32, 34, 42, 43, 49, 50
thermophile	53
thermogenesis	7
two-node model	16, 36, 42, 56, 64
vapour pressure	10, 12, 17, 18, 32, 38, 41
variable indoor comfort	52
vasoconstriction	7
vasodilation	6
wet bulb temperature	10, 12, 21