



# After the Tsunami

Sustainable building guidelines  
for South-East Asia



UNEP SBCI  
Sustainable Buildings &  
Construction Initiative

**skat** Swiss Resource Centre and  
Consultancies for Development



**UNEP SBCI**  
**Sustainable Buildings &  
Construction Initiative**

**skat** Swiss Resource Centre and  
Consultancies for Development

Vadianstrasse 42 CH-9000 St.Gallen, Switzerland  
[www.skat.ch](http://www.skat.ch)

Copyright © United Nations Environment Programme and SKAT, 2007

ISBN: 978-92-807-2782-1

Job no.: DTI/0903/PA

#### **Disclaimer**

*This publication may be reproduced in whole or in part and in any form of educational or non-profit services without special permission from the copyright holder, provided acknowledgement of the source is made. UNEP would appreciate receiving a copy of any publication that uses this publication as a source. No use of this publication may be made for resale or any other commercial purpose whatsoever without prior permission in writing from UNEP. Applications for such permission, with a statement of the purpose and extent of the reproduction, should be addressed to the Director, DCPI, UNEP, P.O. Box 30552, Nairobi, Kenya. While reasonable efforts have been made to ensure that the contents of this publication are factually correct, UNEP does not accept responsibility for the accuracy and completeness of the information used in this publication, and shall not be liable for any loss or damage that may be occasioned directly or indirectly through the use of, or reliance on, the contents of this publication, including its translation into other languages than English. The opinions indicated in this publication should not necessarily be considered as reflecting the views or carrying the endorsement of the United Nations Environment Programme. Mention of a commercial company or product in this publication does not imply endorsement by the United Nations Environment Programme.*

Design and Layout: Rachel Dolores

Cover photo: SKAT

Printer: Sadag, France

Printed on Recycled Paper

*Unless otherwise credited, all the photos in this publication have been taken by the UNEP staff.*

UNEP promotes environmentally sound practices globally and in its own activities. This publication is printed on recycled paper using vegetable-based inks and other eco-friendly practices. Our distribution policy aims to reduce UNEP's carbon footprint.



# **After the Tsunami**

Sustainable building guidelines  
for South-East Asia

# TABLE OF CONTENTS

Executive summary .....	3
Glossary .....	4
1. Introduction .....	6
1.1 About this manual .....	6
1.2 Target group .....	6
1.3 How to use the manual .....	6
1.4 Overview .....	7
2. Introduction to Sustainable Reconstruction .....	9
2.1 The concept of sustainable development .....	9
2.2 What is sustainable reconstruction? .....	9
2.3 Why is sustainable reconstruction necessary? .....	10
2.4 Principles of sustainable reconstruction: .....	11
3. Guidelines for Sustainable Reconstruction .....	15
3.1 Site Selection .....	15
3.2 Project definition .....	18
3.3 Develop the detailed site plan .....	22
3.4. Sustainable house design .....	24
3.5 Services: Water, Sanitation, Waste and Energy .....	34
3.6 Construction .....	47
3.7 Maintenance .....	47
Annex I : Endnotes .....	49
Annex II : References and links .....	49
Annex III : Sustainable reconstruction indicators .....	52
Annex IV : Summary of the regulations and building code issued by the government of indonesia .....	53
Annex V : Assessment of strength of natural soils (not fills or organic clays/silts) .....	54
Annex VI : A few basics on quality and material testing methods .....	55
Annex VII : Selected manufacturers and suppliers .....	56
Annex VIII : Project environmental review record .....	57
Annex IX : Acknowledgements .....	62
Annex X : Contacts .....	64

## EXECUTIVE SUMMARY

The Indian Ocean earthquake and tsunami 26 December 2004 (the “Tsunami”) severely affected the coastal areas of the Indonesian province of Aceh, Sri Lanka, Thailand, Southern India, the Maldives, Malaysia, and Myanmar, taking over 250,000 lives, leaving millions homeless or displaced and causing enormous destruction and suffering. In the aftermath of the disaster, survivors found shelter in temporary barracks and tents, and one of the most pressing needs remains to provide adequate permanent housing. In Aceh, for example, it has been estimated that 92,000 new houses need to be rebuilt and 151,000 damaged houses rehabilitated<sup>1</sup>.

Numerous agencies have taken on the task of reconstructing houses and infrastructure in the aftermath of the tsunami. Project managers, however, are often overwhelmed by the magnitude of the reconstruction challenges they are confronting, the principal one being the need to produce conceptually sound, practical building solutions that minimise environmental impacts.

This manual designed to help project managers meet this challenge by providing them with guidance in the area of ‘sustainable reconstruction’. The manual explains how the choice of appropriate design and construction methods

and sustainable materials and technologies during the planning, implementation and maintenance phases of reconstruction can protect natural resources and reduce energy consumption and pollution.

Sustainable reconstruction management provides numerous environmental, safety and financial benefits. Construction waste, dust and noise emissions are minimised. Energy-efficient building technologies reduce fuel and power consumption and offer long-term cost savings, while improving health and safety conditions. Initiatives meet user needs and are adjusted to local cultural norms and legal requirements, in particular, government acts, rules and regulations concerning reconstruction and natural disaster mitigation, gaining the support of relevant institutions and local political leaders. And by using locally available and certified source materials or products, sustainable reconstruction provides important knock-on benefits for local livelihoods and resource management. Taken together, sustainable reconstruction management’s many benefits offer donors and reconstruction authorities an important opportunity to ensure that their efforts result in net positive environmental or social impacts to local communities – i.e., to truly ‘build back better.’”

<sup>1</sup> See BRR projections in *ADB-ETESP-Spatial Planning and Environmental Management, Draft Guidelines: Environmentally Friendly Construction Material Procurement, Asian Development Bank* (2006).

## ACRONYMS

ALNAP	Active Learning Network for Accountability and Performance in Humanitarian Action
CBO	Community Based Organisation
CFC	Chlorofluorocarbons (an ozone depleting substance)
CEB	Compressed Earth Blocks
DMB	Disaster Management Branch (UNEP)
DTIE	Division of Technology, Industry and Economics (UNEP)
EIA	Environmental Impact Assessment
ITDG	Intermediate Technology Development Group (now: Practical Action), UK-based NGO
M&E	Monitoring and Evaluation
MoU	Memorandum of Understanding
NGO	Non-Governmental Organisation
SWM	Solid Waste Management
WS&S	Water Supply and Sanitation
UN	United Nations
UNEP	United Nations Environment Programme
VS BK	Vertical Shaft Brick Kiln



## GLOSSARY

Black water	Heavily contaminated wastewater, e.g., toilet wastewater. Black water is also known as 'brown water', black water is heavily polluted and difficult to treat because of high concentrations of mostly organic pollution.
Buffer zone	A buffer zone is a land area designated for safety purposes that includes the highest sea level previously flooded (e.g., the Tsunami level), together with an additional buffer area.
Community rehabilitation	Community rehabilitation involves mobilising community members and providing them with, or enabling them to provide for themselves, a safe, secure and enabling environment. Community rehabilitation entails restoring infrastructure and basic services, such as energy, water, sanitation, healthcare, education, access to information, as well as providing less tangible forms of support, such as counselling and groups for awareness building.
Disaster management	Disaster management is the body of policy, administrative decisions and operational activities required to prepare for, mitigate, respond to, and repair the effects of natural or man-made disasters. Effective disaster management relies on the development and thorough integration of emergency plans by all levels of government and civil society
Disaster mitigation	Actions taken to eliminate or minimise the effects of disasters, including measures to eliminate or reduce risks or prevent hazards from developing into disasters.
Disaster preparedness	Disaster preparedness minimises the adverse effects of hazards through effective precautionary actions, rehabilitation and recovery measures to ensure the timely, appropriate and effective organisation and delivery of relief and assistance following a disaster. Preparedness measures include plans of action for potential disasters, maintenance and training of emergency services, the development and exercise of emergency population warning methods combined with emergency shelters and evacuation plans, the stockpiling of supplies and equipment and the development and practice of multi-agency coordination.
Disaster prevention	The body of policy and administrative decisions and operational activities related to preventing, managing and mitigating the various stages of disasters at all levels.
Disaster recovery	The restoration of an affected area to its previous state. Disaster recovery involves policies, decisions and activities developed and implemented after immediate needs in disaster areas have been addressed. Recovery activities include rebuilding destroyed property, re-employment, and the repair of other essential infrastructure. Recovery efforts are most effective and most widely accepted by communities when mitigation measures are implemented swiftly.
Ecosystems	Distinct units of the biosphere, including living organisms (plants, animals, micro-organisms) and nonliving components, their interactions and other processes specific to the ecosystem's physical area.
Embodied energy	The quantity of energy required to acquire primary material, manufacture handle and transport to the point of use a product, material or service.
Energy conservation	The practice of reducing the amount of energy used to obtain an outcome or produce an output.
Environmental Impact Assessment (EIA)	An EIA is a formal process used to assess a project's potential impact on human health and the environment. The purpose of the EIA is to enable decision-makers to consider the environmental impacts and options for minimizing them before deciding whether to proceed with the project.

Grey water	Wastewater that is generated from processes such as washing dishes, laundry and bathing.
Irrigation	Water artificially supplied (by, e.g., pipes, ditches or streams) for the purpose of watering grass, trees, and other plants.
Livelihood rebuilding	The provision of support to major occupation sectors (fishery, agriculture, tourism) as well as families with specific needs (e.g., home-based work for single-person households).
Photovoltaic (PV) cell	A device that converts sunlight directly into electricity using cells made of silicon or other conductive materials.
Pollution	Harmful substances (gases, liquids and solids) that have been released into the environment.
Quarry	A site from which rocks, gravel, sand or clay is extracted in substantial quantities.
Recycling	Systems and processes for collecting, sorting, and reprocessing used products, substances and materials into raw material suitable for reuse.
Renewable energy	Renewable energy resources capture their energy from natural energy sources, such as sunlight, wind, and hydropower, biogas, and geothermal heat that are self-replenishing (as opposed to non-renewable energy sources, e.g., oil, gas and coal, that are can only be used one time).
Reuse	The employment of a product, substance or material, once again for its original purpose, or for a different purpose, without prior processing to change its physical or chemical characteristics.
Reverse Osmosis (RO)	A membrane separation process designed to treat wastewater or seawater containing a variety of contaminants including organic compounds.
Risk management	The process of measuring or assessing risk and developing strategies to manage it. Strategies include avoiding the risk, reducing the negative effect of the risk, and accepting some or all of the consequences of a particular risk.
Sulphur dioxide (SO <sub>2</sub> )	A gas that causes acid rain. Burning fossil fuels, such as coal, releases SO <sub>2</sub> into the atmosphere.
Sustainability	The notion that societies can plan and organise their economic, political and social activities in a manner that will meet their needs and express their greatest potential in the present, while preserving ecosystems, biodiversity and natural resources for future generations.
Sustainable reconstruction	Reconstruction activities that are guided in their planning, design and implementation by the goal of sustainability.
Users	The beneficiaries and residents of reconstructed housing.
Waste management	Strategies and systems for collecting, transporting, processing (waste treatment), recycling or disposing of waste materials.

## 1.1 About this manual

In post-disaster settings such as those found in the aftermath of the Tsunami, the urgency and scale of the need for shelter poses a tremendous challenge. This manual provides guidance regarding key aspects of sustainable reconstruction.

The manual's main objective is to help improve the design and reconstruction of houses after the Tsunami and, in so doing, to minimise the negative impacts of poorly constructed houses on the environment. The aim is to raise awareness of sustainable reconstruction and to encourage project managers as well as planners to adapt this approach wherever possible in their projects. The manual serves as a reference. While the manual is intended to be as comprehensive as possible, it cannot be considered complete and does not represent a scientific study of sustainable reconstruction practices. Nor, on the other hand, does it provide ready-made solutions for construction projects, each of which differ according to locations, budgets and other conditions.

Although the focus of this manual is on housing, the reader will likely find some of the information applicable to other types of buildings (schools, health facilities, etc.).

The manual concentrates on the *physical* aspects of reconstruction, which provide the basis for, and go hand in hand with, community rehabilitation and the rebuilding of livelihoods. The manual will not go into the details of community rehabilitation and livelihood rebuilding.

## 1.2 Target group

The manual has been designed for the benefit of international donors, development agencies, NGOs, UN agencies, and government institutions as well as local authorities engaged in Tsunami reconstruction activities. A house cannot be built without fundamental knowledge of building materials and technologies. Therefore, reconstruction implementers should as far as possible, engage qualified personnel such as project supervisors, planners, and architects. These should not only have technical and organisational capacities, but also be excellent in managing teams and have good interpersonal relationships. Successful reconstruction projects are typically managed by implementers that are highly committed to the project and are good team leaders.

This manual was designed to assist such on-site personnel in their efforts to meet the many challenges that arise in reconstruction projects.

## 1.3 How to use the manual

Key challenges that face those reconstructing houses include choosing and obtaining building materials and technologies, achieving cost-effectiveness and affordability, gaining access to information, using environmentally sound and energy efficient building practices, and winning institutional and community acceptance. The manual, therefore, addresses the following aspects of sustainable reconstruction:



### Technical:

Practical, robust and technically feasible solutions.



### Economic:

Cost-effective solutions.



### Environmental:

Environmental impacts (positive as well as negative), disaster risks and vulnerability, etc.



### Institutional:

Laws and regulations and their enforcement, relevant institutions.



### Social:

Health and safety issues, user-friendliness, adaptability to the users' needs and living conditions, acceptance by users, etc.

The manual should be used as a flexible tool. Regardless of the stage of a project, a project manager can consult the manual at any point. Information in a number of formats:

- **Poster:** A poster in the manual contains a flowchart picturing the main project steps with the most important recommendations.
- **Boxes:** Case studies, examples or checklists are illustrated in text boxes.
- **Further information links:** Bearing in mind that the manual is not exhaustive, an annex suggests further reading and information resources.





Houses in Sri Lanka rebuilt after the tsunami.

## 1.4 Overview

The manual is organised according to the typical main steps of a reconstruction project. These are outlined in the following table, with key recommendations for each step summarised. Each of these issues is more fully elaborated in the manual's subsequent chapters.

	Main steps	Recommendations
1	Site selection	<ul style="list-style-type: none"> <li>• Assess risks from natural hazards</li> <li>• Assess vulnerability of environment</li> <li>• Identify surrounding settlements/activities</li> <li>• Assess stability of ground/soil</li> <li>• Assess access to water, sanitation, energy, transport</li> <li>• Check land ownership and right to build</li> <li>• Ensure location meets the tenant's requirements</li> </ul>
2	Project definition	<ul style="list-style-type: none"> <li>• Develop a project description, based on environmental, technical, economic, social and institutional conditions</li> <li>• Select implementation approach (contractor or owner driven)</li> <li>• Develop management tools, including an action plan (log-frame matrix), time schedule, budget and monitoring plan</li> </ul>
3	Develop detailed site plan	<ul style="list-style-type: none"> <li>• Indicate houses, access roads, infrastructure and services, green, commercial, and religious areas</li> <li>• Identify required disaster preparedness measures</li> <li>• Carry out an Environmental Impact Assessment</li> <li>• Identify if any existing structures can be reused/integrated with the new buildings</li> <li>• Ensure compliance with zoning and other regulations</li> <li>• Explore expectations of future tenants</li> <li>• Provide for green areas</li> <li>• Maintain social context</li> <li>• Clarify what rights the residents will have (to sell, rent)</li> </ul>

	Main steps	Recommendations
4	Sustainable house design	<ul style="list-style-type: none"> <li>• Select a house shape that suits the climate and culture, and that is earthquake, cyclone, and flood resistant</li> <li>• Choose building design and materials that are energy-efficient, environmentally appropriate, low-cost and practical</li> <li>• Select building components (supporting frame, foundation, floors, walls, roof) according to climate and ensure their earthquake, flood, and cyclone resistance</li> <li>• Make sure that materials used are sustainable (environmentally friendly, non-toxic, derived from sustainable sources, of good quality, and socially accepted)</li> <li>• Consider reuse or recycling of building material and temporary shelters</li> <li>• Design kitchens and stoves to ensure cultural acceptance, hygiene, smoke-less cooking, and safety</li> </ul>
5	Sustainable services	<ul style="list-style-type: none"> <li>• Select an appropriate water supply and sanitation system</li> <li>• Integrate a sustainable solid waste management system</li> <li>• Select a sustainable power system that, to extent possible, uses renewable energy sources</li> </ul>
6	Construction	<ul style="list-style-type: none"> <li>• Use monitoring &amp; evaluation for control of materials use, environmental impact and workplace safety</li> <li>• Perform quality control of materials and work</li> <li>• Ensure that construction waste is disposed properly</li> <li>• Maintain safe, healthy, and socially just working conditions</li> <li>• Store fuel and chemicals in contained areas to avoid leakage</li> <li>• Minimise transport as far as possible</li> </ul>
7	Maintenance	<ul style="list-style-type: none"> <li>• Design the house for easy and self-evident care &amp; maintenance</li> <li>• Ensure all materials can be worked/repared locally</li> <li>• Fully test any and all systems (water, toilets, energy, waste disposal, cleaning, etc.)</li> <li>• Provide a checklist of regular actions needed (e.g., cleaning of storm water drains, vegetation control, cleaning of air conditioning units, etc.)</li> <li>• Provide in project plan and budget for instruction and training of house owner</li> </ul>

## 2.1 The concept of sustainable development

The influence of human activities on the global environment<sup>1</sup> has been subject to much research, discussion and deliberation for several decades. In 1987, the Brundtland Commission<sup>2</sup> generated what is probably the most commonly cited definition of sustainable development. According to the Commission, development is sustainable when it “meets the needs of the present generation without compromising the ability of future generations to meet their own needs.”<sup>3</sup> Achieving this goal requires balancing the interests of environment, social equity, and the economy.

## 2.2 What is sustainable reconstruction?

Sustainable reconstruction is an integrated approach to reconstruction. Environmental, technical, economic, social, and institutional concerns are considered in each stage and activity of reconstruction to ensure the best long-term result, not only in house design and construction activities, but also in the provision of related infrastructure such as water supply and sanitation systems. As a result of buildings' enhanced performances during construction, use and demolition phases, sustainable reconstruction offers a variety of knock-on environmental, economic and social benefits.

Sustainable reconstruction also looks beyond the structure of a single house to how settlements are laid out. The design of houses, infrastructure and green spaces of a neighbourhood shape the larger settlement and, therefore, have a larger effect on the community's and the user's energy use, biodiversity and quality of life.

The exact criteria for sustainability may differ from one location to another. Programme managers will need to work together with users and other relevant stakeholders to define the scope and application of sustainable reconstruction in their specific context.

Examples of environmental, technical, economic, social, and institutional criteria are described in the following list:



### Environmental

- Environmental characteristics of construction material: safe, durable, and not from sources that are overexploited or threatened (e.g., unsustainably harvested wood).

- Resistance of the house construction to natural disaster
- Low generation of waste during production and construction; and high potential for waste reuse or recycling
- Sustainable energy supply, if possible, making use of renewable energy sources
- House design adjusted to local climate (e.g., use of natural lighting and cooling systems)



### Technical

- Practical, technically easy and feasible solutions; field-tested construction technologies
- Safety of house design: compliance with building codes, awareness about safe building and quality of construction



### Economic

- Low-cost building design
- Effect on local economy: community involvement in production and construction, support and strengthening of local skills, enterprise development
- Economic feasibility ( building costs and overall affordability)



### Social

- Flexible house design/ adaptability to the users' needs and living conditions
- Social and cultural relevance of house design, village planning and capacity building of communities
- Employment creation
- Vocational training
- Home-based income generation



### Institutional

- Environmental governance
- Environmental Impact Assessment
- Comprehensive building codes and their enforcement
- Reliable local authorities with efficient provision of building permits and planning permissions
- Clear land ownership



Public meeting about how to carry out reconstruction in Sri Lanka

### 2.3 Why is sustainable reconstruction necessary?

Sustainable reconstruction offers the chance to improve the quality of buildings, the environment and life itself in disaster-affected regions. Natural disasters and other catastrophes create enormous pressure to provide survivors with adequate permanent housing as rapidly as possible. The urgent need for housing normally leads to numerous or large-scale reconstruction programmes and huge demand for construction material.

For example, since the 2004 Tsunami, several hundreds of organisations have been implementing reconstruction and development projects in the affected regions. In such situations, the potential environmental impact of reconstruction is considerable. Improperly managed resource exploitation for construction materials can result in deforestation, pollution of water resources, damage to coral reefs, and depletion of locally available materials. The construction process in itself can also result in waste generation, water and air pollution and poor living conditions for future residents.

The mitigation of natural disaster risks, however, requires building a culture of prevention. Disaster management should not be overlooked in the rush to restore life to pre-disaster conditions. The pressure to regain equilibrium as quickly as possible must be balanced with seizing opportunities for long-term risk reduction and community improvements through sustainable reconstruction. Sustainable reconstruction is designed to address such challenges by providing an integrated framework for action.

Well constructed houses and a safe and sustainable environment is a human right. Adequate housing is essential for human survival with dignity. Without secure housing basic rights to family life and privacy, freedom of movement, assembly and association, health and development are compromised.

Former UN Secretary General Kofi Annan, during his visit to Maldives on 9 January 2005, urged the Government to aspire to 'recovery plus' – not just rebuilding what had existed, but also improving its quality. Sustainable reconstruction represents an opportunity to put the concept of 'recovery plus' into action. The mitigation of natural disaster risks entails building a culture of prevention.

In Aceh province, masonry needs for the construction of 120,000 houses has been projected to be more than 1 million tons of cement and 3.6 million m<sup>3</sup> of sand<sup>1</sup>. In addition, there is an estimated timber need of between 300,000 and 400,000 m<sup>3</sup>. Estimates from the end of 2005 show that between 25,000 and 50,000 m<sup>3</sup> have been used or are in the supply pipeline<sup>2</sup>. The harvesting and supply of timber in Indonesia, much of it illegal, is a critical issue. The environmental impacts of inadequately managed logging and related activities include a dramatic loss of biodiversity, flooding, soil erosion and land slides.

<sup>1</sup> Environment Agency, 2003, *Sustainable Construction- Position Statement*, Bristol.

<sup>2</sup> Environment Agency, 2003, *Sustainable Construction- Position Statement*, Bristol.





SKAT

Public meeting about how to carry out reconstruction in India

## 2.4 Principles of sustainable reconstruction:

It is important to integrate the principles of sustainability strategically from the earliest stages of reconstruction in order to avoid the risk of building inefficient and risky structures during reconstruction. A few basic principles, which should be kept in mind at all stages of reconstruction, are summarised as follows:

### **Ensure local participation in decision processes**

The active participation of local stakeholders in crucial decisions throughout the project process fosters a strong sense of ownership and acceptance for the project, and helps to facilitate care and maintenance of buildings following construction. This is especially true if the users are also the owners of the houses; rented-out dwellings tend to deteriorate more quickly than owner-occupied homes.

Relevant stakeholders – future house users, community leaders, responsible public authorities, service providers, etc. – can deliver important information and provide support that may be crucial to the project's success and the sustainability.

Ideally, relevant stakeholders should be consulted during the early project definition phase, as well as during planning and implementation phases, in order to establish strong ownership from the beginning. This can be done through a stakeholders' workshop, during which invited stakeholders set project criteria and develop ideas. At this stage, the responsible *local reconstruction agency* can also be consulted in order to ensure their support.

Different types of participation include:

#### *Donor-driven*

Donor-driven projects are often the weakest in terms of stakeholder participation. Beneficiaries typically have no or only little access to reconstruction decision-making processes. As a result, there is ordinarily a high risk that donors will plan and implement projects without understanding or taking into account the needs of the end users and, in turn, that the new houses will not be sufficiently appreciated by the users. Stakeholder inputs to donor-driven projects are rather restricted to the use of certain construction materials or methods, but sometimes extend to the entire house design.

#### *Stakeholder-driven*

In stakeholder-driven projects, users, local authorities, private contractors, and project teams decide together on key issues: site selection, house design, materials, etc. Maximised involvement of the users creates a strong sense of ownership and increased sustainability.

#### *Owner-driven*

In owner-driven projects, also called 'cash for shelter' donors provide mainly financial support and users have great freedom to decide how they would like to use the money for the reconstruction of their houses. Donors may not have much control over the quality of implementation.



Damage from the Indian Ocean tsunami (Banda Aceh). The only thing left is the floor.

### ***Anchor the project in the local context***

Projects can and should be anchored in the local context by taking any or all of the following measures: exploring the availability of local know-how; considering traditional requirements; working together with and not against the local authorities; cooperating with local service providers; using local materials when possible; and building on and optimising local construction technologies.

Anchoring reconstruction projects in the local context can contribute measurably to community buy-in and a project's success and sustainability. Local institutions and organisations included in the project process are strengthened and improved.

### ***Learn from experience of systems that existed before the Tsunami or other natural disaster***

Many mistakes can be avoided by observing and finding out what concepts, and in particular, what construction practices, functioned well before the tsunami. Traditional knowledge and building practices have often evolved over long periods of trial and error, and are often both practical and resource efficient.

### ***Establish and maintain a well-functioning project management***

A well-functioning management process is the backbone for the success of any reconstruction project. Below are key reconstruction project management practices that should normally be considered.

Contracts and roles and responsibilities of partners should be clarified at as early a stage as possible. A clear project set-up includes the following activities:

- Decide on the project's most important objectives
- Select reliable and skilled local partners
- Clarify expectations of partners and stakeholders (donor, national and local partners, implementers, etc.)
- Identify and agree on responsibilities and tasks, and enter a formal written agreement with partners (e.g. an Memorandum of Understanding or contract)
- Set time frame according to the major milestones formulated in the objectives
- Confirm available budget
- Select the location and target group (community)

Other preparation activities include the establishment of an office and management structure:

- Prepare office facilities and infrastructure
- Establish the project team's professional staff, ensuring that they have adequate skills. According to the project's objectives, select a multi-disciplinary team, including engineers (with technical background and substantial experience in housing construction), social workers (with experience in community mobilisation and participatory decision-making processes), economic specialists, etc.
- Formulate team members' job descriptions
- Agree on decision-making procedures





SKAT

Reconstruction should as far as possible make use of local work force and involve the future users of the house.

- Establish office management budget
- Open bank account

### ***Determine communication and knowledge-sharing strategy***

Maintaining effective communication among all the stakeholders is crucial. Numerous sources have reported incidences of hostility towards development agencies by project beneficiaries. There has been a lack of clear and regular communication between project implementers and future users about options, plans, actions, responsibilities, and difficulties encountered in the course of reconstruction projects. It cannot be over-emphasised that all agencies owe beneficiaries the opportunity to know what is being discussed, planned, negotiated, rejected or accepted on their behalves. The internationally accepted guidelines of the Active Learning Network for Accountability and Performance in Humanitarian Action (ALNAP) provide successful lines of communication. (See *An ALNAP Guide for Humanitarian Agencies*, Active Learning Network for Accountability and Performance in Humanitarian Action, UK, 2005.) It is also important to ensure regular reporting and documentation of positive and negative experiences. This is important not only for any necessary handing-over to future project managers, but also for sharing of lessons learnt at international and local level.

### ***Conduct regular monitoring and evaluation (M&E)***

Regular self-monitoring and evaluation is critical for measuring the progress of reconstruction projects. M&E can be carried

out in a rather simple fashion by selecting key indicators (e.g., amounts of money spent on different activities, amounts of materials used, and timeliness of completion of activities) and then collecting and summarising them on a regular basis (e.g., weekly or fortnightly). If any indicator shows a deviation from the budget or construction plans, then the cause for the deviation should be identified, so that remedial measures can be taken. In addition, an external evaluation can assist by providing a second and independent on crucial issues.

M&E can be complemented with 'impact monitoring', which is used to assess the environmental and social impacts of project activities. Impact monitoring provides valuable information about whether the project is in conformance with best sustainability practices (and if not, how it can be improved). Impact monitoring is also very useful for building the project partners' credibility with the local community, national authorities and international donors.

### ***Coordinate with other donors to identify potential synergies***

Responsible local authorities should coordinate all ongoing and planned reconstruction activities, at least at community level. In addition, however, project officials should contact other development organisations (international and national) to determine jointly the geographical and social distribution of reconstruction schemes based on local needs.

Identifying and monitoring the reconstruction activities of other donor organisations and ensuring your project is complementing, not duplicating, other efforts can save

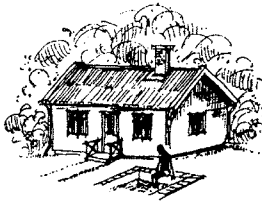
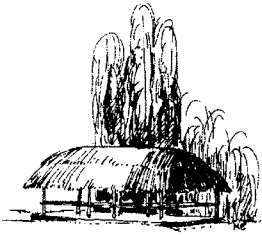

Choice of standard  
(Source: Astrand, 1996)

financial and other resources. There are normally good opportunities to economise on costs, e.g., of access roads, water and sanitation systems and other infrastructure. Donor coordination can also help to ensure the equitable distribution of reconstruction benefits to communities, especially to areas that are less politically popular.

### **Consider the overall development concerns and priorities of your organisation**

Most organisations involved in reconstruction activities have internal guidelines and standards for their activities, including environmental policies. Ensuring that your organisation development goals, procedures and priorities are integrated into your project from the start can help to align projects with sustainable reconstruction objectives and avoid unnecessary costs.

### **Choose life span of houses to be built**

Selecting temporary or permanent shelter options has a huge influence on house design as well as the project's implementation procedures budget and timeframe. It is important to decide early in planning whether the houses should be solid to last 50 years or if they should be simpler with a shorter life span.

### **Provide adequate temporary shelters**

Reconstruction programmes that are seeking to produce quality results require time for realisation. While housing projects are being developed, displaced residents need adequate temporary shelters that ensure humane living conditions and enable residents to re-establish life as fast as possible. Programme budgets should anticipate this need.

### **Consider re-using and recycling temporary housing components for permanent houses to be built**

Components such as well-maintained sanitary and kitchen equipment could be easily reused in new reconstructed houses.

### **Plan in a gender-sensitive manner**

In many communities, women take an active part in disaster-relief initiatives and are often the main users of houses, working at home, taking care of children and elderly in the house, etc. Women's local knowledge and expertise is therefore an extremely rich but largely untapped resource. Women are scarcely represented and often excluded from planning and decision-making processes. Interventions are often only targeted at men. Integrating women into programme decision-making would greatly enhance post-disaster reconstruction efforts. Women can be effectively incorporated into housing design and construction activities through events, meetings and on-going consultation processes. Care should be taken to ensure that opportunities for women to provide inputs are arranged in manners that are sensitive to the daily routines and time constraints of women in the target communities.

### **Develop a risk strategy**

Developing a strategy for how to overcome any potential risks to the project is essential. Risk strategies safeguard the project's continuation, completion and ultimately its sustainability. Strategies should be developed with relevant local stakeholders. The strategies should define how potential obstacles – whether political, economic, security-related or from subsequent natural disasters – should be tackled.

After the 1992 flood disaster in Pakistan, PATTAN, a local NGO, introduced a number of measures to reduce women's vulnerability:

1. Female relief workers were engaged to assess the needs of women during the floods and to involve them in the planning, implementation and rehabilitation activities.
2. Local women were registered as heads of their households to help ensure efficient distribution of relief food.
3. Village women's organisations were established (in parallel to men's groups) to articulate women's needs and take responsibility for community development.
4. Women became actively involved in reconstruction activities. Women's groups provided forums for discussing women's views regarding the design and layout of new houses. Some women participated in the actual construction works, traditionally a male activity at the time. Women were made responsible for collecting money to repay loan instalments on the houses. Perhaps most importantly, PATTAN introduced the concept that married couples should own houses jointly.

In the following sections, guidelines for ensuring the sustainability of a housing project are described for each project phase:

1. Site selection
2. Project Definition
3. Develop the detailed site plan
4. Sustainable House Design
5. Sustainable services
6. Construction
7. Maintenance

### 3.1 Site Selection

Careful site selection is a key step that can determine the success or failure of a reconstruction project. Reconstruction settlements in hazardous areas are vulnerable to floods, landslides, cyclones, etc. An assessment of potential risks at reconstruction sites is, therefore, crucial to avoid repeated destruction. Another challenge is that residents may not accept particular site locations for various reasons, including the site's history or other socio-cultural reasons.

In order to select a suitable construction site, project managers should to consider a number of issues and should verify facts and recommendations with intended users and local stakeholders. The key factors to consider when choosing a site include:



#### Environmental aspects:

- Assess risks from natural hazards (e.g., tidal waves, storm surges, landslides, heavy rainfall, earthquakes and cyclones) and avoid rebuilding in hazards zones. As part of the assessment, check municipal flood records.
  - Vegetation can help mitigate the effect of hazards to settlements. In areas vulnerable to natural hazards, use trees with long root structure (in cyclone areas put them together with bushy shrubs as windbreaks).
  - In tsunami-prone areas try to create a "bio-shield" (e.g., trees, bushes) to slow the tsunami wave.
- Assess site topography: when possible, favour elevated (but flat) sites in order to avoid flooding and use shallow bedrock conditions for seismic protection.
  - Check the slope stability (angle, soil type, drainage, etc.).
  - Assess soil characteristics. This will provide important information for determining foundation type (strip or slab); depth for drilling water wells; and digging holes for septic tanks (rocky ground is not very suitable).
  - Consider whether land filling is needed to elevate new houses above likely flooding levels. Fill material should come from deep borrow pits or controlled sources to avoid causing landslides.
  - Assess impacts from nearby industries and airports (e.g. noise, pollution, etc.) and determine how to minimise disturbances.
  - Check water quality through chemical/physical testing. Determine whether groundwater is contaminated and, if so, arrange the delivery of supplies from safe sources (including rainwater harvesting).
  - Identify the groundwater table's depth. This will be important information for purposes of establishing foundation depth and size as well as the depth and distance between latrine system/septic and water tanks.
  - Assess the site's existing buildings and infrastructure. Determine whether demolition works will be needed or whether, alternatively, existing buildings can be recycled or integrated into the new houses?
  - Assess the site's existing vegetation. Check whether it is necessary to clear trees or bushes from the site or, alternatively, to reforest the site to create a cooler micro-climate or stabilize soils.

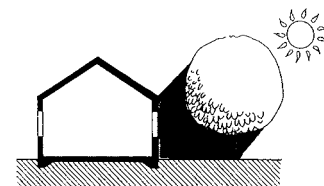

Shade creation  
(Source: Skat)





Project planners should keep in mind that small house units are likely to be expanded over time. Furthermore the roof can often be used as additional space for certain activities why easy access is recommended (see the stair in the picture).



#### Technical:

- Select a site that is out of reach from storm surge and tidal waves. Check with the responsible local authority whether there are any buffer zones, i.e. a safety zone that extends beyond the highest previous level of flooding.
- Analyse access to clean water, roads, shops and markets, schools and health facilities, and employment.
- Analyse conditions and technical requirements for water supply, sanitation, waste management, and power supply.
- Check for existing connections to municipal water mains. Assess their conditions and the measures needed to connect the site to the municipal mains.
- After site selection, check whether local reconstruction materials are available at the site or nearby in order to minimise transport costs.



#### Economic:

Factor the following considerations into project budgets:

- Identify any financial provisions or support schemes that the government (or other institutions) may have made available for the disaster area.
- Land prices and related administrative fees. Normally, landowners are responsible for land-related costs, leasing and administrative fees. The Government should ensure that land prices are kept to a minimum.
- Costs for required land filling and other ground preparation.
- Expenses for the provision of infrastructure on the site (e.g., roads, connection to water, sewage, electricity networks, etc.).

## Placement of houses on sloped sites

In earthquake-affected regions, the following guidelines should be taken into account:

- The house should not be cut into the slope, as the flanking wall might collapse due to horizontal forces.

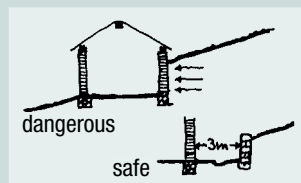

- The house should not be placed onto the slope or it might slip down.



- The house should not be located close to steep slopes or cliffs or it might collapse due to falling rocks or landslides.



- If a sloped area cannot be avoided, platform should be built first and the house should be placed at a secure distance from the adjacent slopes.



- When siting houses on soft sandy undergrounds select massive and heavy house styles. For rocky soils, choose light and flexible structures.

- Avoid multiple floor levels.

(Source: Minke, G., 2001)



### Social:

- Use an appropriate participatory decision-making process to select an appropriate site.
- Ensure users' acceptance of site locations.
- Ensure the locations' accessibility to jobs, shops, health facilities and other infrastructure.
- Consider whether neighbouring settlements of different ethnic groups are an issue.
- Contact representatives of the intended users. If none exist, establish, e.g. a village representatives' committee to function as a focal point for discussions between the developers and the users.
- Assess the issue of resettlement. Relocating residents without their definite acceptance of the new site may cause lead to resistance, users' moving back to their former locations, and other problems.
- Check whether the new area meets the population's need in terms of social infrastructure and economic activities.
- Inform and prepare affected people. It is important to achieve full participation of the target group.
- Especially in the Tsunami region, new settlements should be sited near former settlements, so that fisher people can conduct their economic activities easily.



### Institutional:

- Make sure that land titles are available.
- Clarify who will be the landowner in order to avoid future conflicts and even the eviction of residents.
- Consider what kind of rights the owners should have (e.g., to sell, rent, assign to heirs, etc.).
- Clarify with local authorities the building permits required at the site.

### Field assessment of site quality

- Favour sites on open and even topography over hills and steep slopes.
- Favour several houses on terraces over having a large house with foundations at different levels.
- Avoid sites that are likely to liquefy during an earthquake.
- Avoid building on unstable slopes that could fail or slide during an earthquake.
- Houses built on solid rocks and firm soils endure better than houses on soft sandy, clay or silty grounds.
- For further information about assessing **soil strengths** please see Annex V.

### A few hints about how to assess flood safety

- Consult local authorities for flood records.
- Ask neighbours and older residents about previous flooding.
- If possible, identify benchmarks from high tides.

## 3.2 Project definition

The project definition stage is crucial for attaining a well functioning and sustainable reconstruction concept.

The main activities of the project definition stage include:

1. Developing a project description based on environmental, technical, economic, social and institutional conditions.
2. Selecting an implementation approach (contractor or owner driven).
3. Developing the necessary management tools, including an action plan (log-frame matrix), time schedule, budget and monitoring plan.

### 3.2.1 Developing a project description

Housing reconstruction projects have various, often quite complex aspects. In order to ensure that reconstruction is sustainable and best reflects the needs of affected families, programme or project managers should develop a project description that includes a comprehensive assessment and analyses the area's existing conditions and other key issues. The following issues should be considered in the project description:



#### Environmental:

- Consider the potential impacts on biodiversity. Check with national and local experts (e.g., at universities or local nature-oriented NGO's) to learn whether there are any sensitive habitats for flora or fauna in the area. Such areas should always be avoided for housing projects.
- Estimate the potential negative environmental effects (impact on fresh water supplies; generation of waste, waste water, noise and air pollution) from establishing housing in the selected area.
- Assess whether existing systems support effective management of these challenges or whether new systems be required?
- Estimate the environmental impacts, if any, from existing or planned activities nearby on the planned reconstructed houses (noise, pollution, smell, etc.).
- Calculate the number of temporary shelters and how many can be integrated into the new houses or re-used in whole or in part.



#### Technical:

- Assess the extent to which buildings and infrastructure on the site have been damaged or otherwise rendered unsuitable for use and require demolition as well as the machines and materials needed for clean up.



#### Economic:

- Assess the impact on the project if costs increase (e.g., building material prices, labour costs, etc). It is not uncommon in post-disaster situations that the costs of material and work increase substantially because of higher demand and limited supply.
- Explore co-funding opportunities with donors and national partners.
- Assess how much the beneficiaries can contribute (in cash/time/labour).
- Analyse whether the project may be able to benefit from any financial provisions or support schemes that the Government (or other institutions) may have made available for the disaster area.: Identify who can access the support and under what conditions.



#### Social:

- Assess social support structures and networks (Professional associations, women groups, family networks, etc.) and how they could contribute to the reconstruction project. In disaster situations, social networks provide important support by filling gaps that official institutions do not fulfil and enabling survivors to help one another. Maintaining similar neighbourhood arrangements whilst moving from destroyed settlements to reconstructed ones helps in sustaining social networks.
- Assess the status of future residents. A comprehensive list of the affected households can assist. The list may contain: number of household members, sizes of families, number of men-/women-headed households, income sources, assets, etc. Consider that changes in the household list may occur quite frequently.
- Analyse the social and cultural needs and habits of men and women, which may be different, and think about of how to accommodate diverse needs.
- Analyse to what extent the community would be available to join the labour force on the construction site, their skills, the activities they could perform, and whether additional training would be needed. This step is important in order to instil in future owners feelings of ownership and a commitment to maintaining and caring the house.



#### Institutional:

- Clarify the project's local institutional context. By understanding what roles and interactions different authorities and organisations have, as well as their responsibilities, capacities and degrees of



#### Summary of Government of Indonesia's financial support for the post-Tsunami reconstruction in Banda Aceh:

The Tsunami disaster in Aceh caused an estimated USD 6.1 billion in physical losses and damage. According to the World Bank, by June 2006, international donors allocated a total of USD 4.9 billion worth to reconstruction efforts in Aceh of which the Government of Indonesia contributed an additional USD 1.2 billion.

The policy of the Government of Indonesia was to provide cash compensation of Rp. 3,000 (approximately USD 0.32) per day to each affected person for a period of six months. In addition to payments being delayed beneficiaries perceived the contribution as being very small to sustain life.

accessibility, the project manager can make better decisions. Stakeholders may comprise the residents, agencies, public institutions (local, district, provincial, national), local leaders, CBOs and NGOs.

- Familiarise yourself with government policies towards disaster prevention, disaster mitigation and development activities, which can help or hinder the project in many ways.
- Find out if any disaster preparedness systems or emergency management plans are relevant for the project.
- Assess government procedures, standards and building codes that are relevant for the project's implementation, and make plans for acquiring building permission.
- Consider whether there are any risks of political instability or deteriorating security that could affect the project. Identify or develop emergency plans for these situations.

### 3.2.2 Selecting an implementation approach

Based on the project description, project managers should select an approach, or delivery strategy, for implementing their reconstruction project. Types of delivery strategies include the following:

#### *Donor-driven delivery*

Donor agencies hire contractors (commercial enterprises), who provide entire implementation of the construction and related services. Contractors should be required to use sustainable building technologies in an effective,

#### **Tendering process:**

- Procure information about contractors, visit companies, and conduct interviews
- Draft and send out tender documents/public tender announcement
- Contractors formulate and send back tenders
- Tender analysis
- Document proposal for awarding contract
- Select contractor and contracting

professional and quality-conscious manner. This approach is often comparatively expensive and frequently has low support and buy-in from future residents of the houses.

#### *'Mixed donor-owner driven' delivery:*

Contractors set up all solid construction parts, while the users take responsibility for smaller components and finishing works, such as painting, installing doors and windows, furniture, floors, kitchen/bath equipment, etc. This approach also depends on the extent of the users' resources, whether cash or in-kind (i.e., labour contributions, from savings or small loans (i.e., community or state loan system, micro-credit, etc.). This mixed donor-owner driven approach is often cheaper and gets more acceptance and support from future residents.

#### *Owner-driven delivery:*

Donor agencies provide affected families with phased cash grants and the families manage the rebuilding of their houses on their own. Users can contribute with their own resources, if available, whether cash or in-kind. This strategy often requires that the families involved receive training. The drawback of this approach is that programme coordinators and donors may have difficulties knowing and controlling how owners use cash for reconstruction. On the other hand, the residents' support and buy-in is often high under this approach.

When selecting the type of implementation approach UNEP also recommends the following additional steps:

- Check **requirements of the tendering process** (by the government or your own organisation). If sustainability aspects are not already required, include them (e.g., materials from certified sources, classified specifications, etc.). The tendering requirements are very important in determining what implementation approach is most suitable, what the total project cost will be, and how long time the process will take.
- Consider whether there is a need for **training and capacity building** of stakeholders (e.g., local service providers, site workers, residents, local authorities, etc.). Note that the reconstruction of higher quality houses requires greater technical skills for initial construction but also for renovations and sustainable maintenance later on.

In Banda Aceh, ArCli (Architecture Clinic for Aceh) - a joint initiative by GTZ, Holcim and the Indonesian Chamber of Architects promotes sustainable building technologies. The centre has eight model housing examples that represent a range of design solutions developed by various organisations. The centre aims at promoting sustainable building materials and technologies. The objective is to simplify house construction so that non-skilled community workers from communities are capable of constructing secure, high-quality houses. ArCli offers training at ArCli training workshops and in the villages directly.

### 3.2.3 Establishing an action plan

An action plan contains major milestones, timeframes and costs, and identifies the parties responsible for each activity. The Logical Framework Matrix ("log-frame") is a useful tool for structuring and describing the action plan. Below is an example (not complete) of how a log-frame might look for a housing project. Log-frames come in many different forms. Project implementers should use the form they feel most comfortable with. It is also possible to include/exclude elements, as long as the log-frame maintains its overall logical approach, links wider objectives and needs with specific results, activities and indicators.

### 3.2.4 Time schedule

A project time schedule should include all steps of the reconstruction project. The schedule is a time plan for ensuring that materials, services and works are carried out in a logical sequence and timely manner. It is also wise to develop a strategy for handling time delays. The strategy has to be based on local resources and opportunities.

### 3.2.5 Project budget

Together with the time schedule and the log-frame, the project budget is the key management tools for any cost-effective sustainable reconstruction project. The project manager prepares a budget which considers necessary financial allocations according to the time plan.

Usually, the project manager establishes a cost calculation during the early planning phase so that he/she can calculate all project costs. While the costs included in the budget should only include activities carried out within the project itself, it is strongly recommended that a life-cycle approach be taken for identifying the most cost-effective housing designs (see box).

When calculating project costs, include not only costs for materials and work, but also for transport, energy, permitting/licensing, insurance, monitoring/evaluation, construction waste handling, and connections to existing infrastructure (roads, pipes, sewerage, electricity, phone line, etc).

Additional recommended steps include:

- Factor in inflation or potential price rises for materials and services, and develop a strategy for coping with them. It is often quite reasonable to assume up to 50% increase in the price for some services or materials.
- Determine together with users the level of their contributions (in-kind or cash).
- Assess whether the donor would allow a higher budget for environmental or social benefits.
- Explore co-funding opportunities

Life cycle costs include:

- Investment (plot, materials, transport, construction, labour, machines, fuel)
- Operation (energy, electricity)
- Maintenance (repairs, replacement)
- Demolishing & recycling/disposal (labour, fuel, transport, machines, material)

Manage life cycle costs through:

- Defining the project's scope, level of quality and budget.
- Monitor these three components.

Life cycle costs can be minimised through:

- Compact and simple house design, which is faster to construct and easier to maintain.
- Avoid complicated roof shapes.
- Avoid many angles in external walls.
- Use local and robust materials.

( See also to section 3.4)

## Sample log-frame matrix

Overall objective	Indicators	Assumptions		
Long-term vulnerability to disasters of Tsunami-affected communities in ... region is substantially reduced.	1.1 Human development index of ...region is improved by ....	No other major natural disasters occur.		
Project purposes	Indicators	Assumptions		
1. 1,259 families in four villages are rehabilitated in safe and sustainable habitat.	1.1 Percentage of reconstructed houses that comply with regional safety and environmental standards.	Regional safety and environmental standards exist and applicable.		
Results	Indicators	Assumptions		
1. Development of three village settlements in safe locations with necessary community infrastructure and facilities. 2. Reconstruction of 1,259 houses that are technically safe for multiple hazard situations (e.g., cyclone and earthquake resistant) and environment friendly (shelter & basic amenities)	1.1 Settlement design approved by village community representatives. 1.2 Settlement layouts and design of community. infrastructure approved by concerned government agency. 2.1 Physical development of villages as per drawings and approvals.	1. Village community representatives have the good will and commitment to support the reconstruction initiative. 2. Good architect and planners are available.		
Project activities	Means of verification	Assumptions	Costs	Time frame/ responsible person
1.1 Procurement of land title from the government  2.1 Approval of designs by village community and concerned local authority. ...and so on	1.1 Copy of letter with notification from the government received  2.1 Protocol of approving session	1. Appropriate land is available  2. Local authority has high commitment to the reconstruction project	1.1 Working hours 1.2 Land title fees 2.1 Working hours	1.1 by 30 Nov 2008/ Roger N.  2.1 by 15 January 2009/ Peter M.
Risks	Risk mitigation concept	Activities to mitigate risks	Expected outcome	
<b>a. to achieving results</b> 1. Unexpected natural disaster occurs (e.g., big earthquake)  2. Substandard construction material is delivered to the site	1. Earthquake resistant settlement  2. Quality management and control	1.1 Houses are built to be earthquake resistant from the foundation upwards 2.1 Establish a working strategy for how to control quality of delivered material	1.1 Houses resistant to earthquakes of specified magnitudes  2.1 Material is controlled regularly at site	
<b>b. to achieving project purposes</b> 1. Missing commitment by local implementers	1. Strategy... 2. ...	1.1 ... 1.2 ... 2.1 ...	1. ... 2. ...	
<b>c. to achieving overall objective</b> 1. Political instability	1. ... 2. ...	1.1 ... 1.2 ... 2.1 ...	1. ... 2. ...	

### 3.3 Develop the detailed site plan

After having selected a suitable site location, a site plan needs to be developed. Site plans are usually done by a (urban) planner or architect and should be based on the site analysis. The plan addresses prevailing natural hazards and local climate conditions. It contains all necessary information about further potential risks, density of houses, roads, vegetation, and access to infrastructure. Houses should be designed in such a way that they have the least impact on the surrounding environment or nearby eco-systems.

Careful planning is required to establish the houses' orientation on the plots, where infrastructure (piping and other services) is laid, the integration of suitable vegetation, the arrangements of external and internal spaces and socio-cultural requirements.

Before developing the site plan, check the overall master plan of the region, town or village, if any, to ensure compliance with its requirements. Master plans usually cover larger areas than settlement plans, which normally apply to only one neighbourhood.



Building plans for houses and neighborhood are essential to develop in cooperation with all stakeholders

The following aspects need to be considered:



#### Environmental aspects:

- Comply with coastal conservation zones and safety buffer zones. Local and national land planning authorities can provide such information.
- Carry out an Environmental Impact Assessment (EIA) to identify potential negative impacts on the environment and opportunities to avoid or mitigate such impacts.

- Protect existing vegetation, such as trees, bushes, etc. Plan to replant additional trees. Vegetation is important to provide shading and to cool and improve air quality. (Vegetation has an absorptive capacity for many pollutants, including some greenhouse gases). Vegetation also provides storm and flood protection, can contribute to local food or materials production, and has aesthetic and recreational value, enhancing an area's overall quality.
- Vegetated mounds can serve as an additional buffer against storms or tidal waves.
- In areas at risk from cyclones, consider arranging the houses in clusters (rather than rows).
- Face house openings toward the sea and consider dominant wind directions when designing buildings, to take advantage of natural ventilation.
- Cluster houses in a staggered pattern to allow proper ventilation. Zigzag patterns avoid wind tunnel effects.

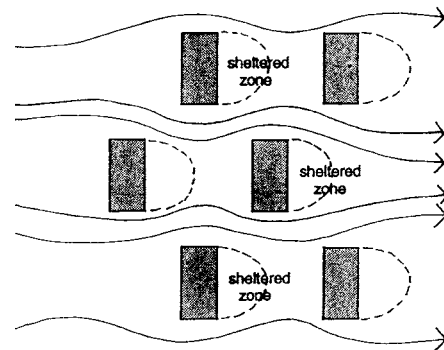

(Source: Gut, Ackerknecht, 1993)

- Use natural topography: place new houses at higher levels than previous, destroyed ones. An "island design" for villages can be appropriate. For example, in the Indian Ganges basin, increasing village heights to above normal water level is a traditional response to floods.
- Consider using infrastructure that mitigates flooding: culverts, bridges, drainage canals can be used to regulate seasonal monsoon flooding.
- In order to protect natural resources and scarce land for agriculture, houses should be situated on plots in a manner that minimises land use impact and optimises the land's value.
- Orient houses on the land to optimise the use of sun and wind. In a hot climate, the east and west facades should be shaded in order to minimise solar heating, especially during morning and afternoon hours, and heat gain of external walls, thus minimising indoor temperatures and improving users' comfort.



SKAT

Site selection - even for temporary shelters - is important so as to avoid repeated damage by natural disasters such as flooding.

- Select the appropriate systems for water supply, sanitation, waste management and power systems: centralised (public or private owned) or de-centralised (independent, at household level).
- Arrange contracts with service providers or municipality as early as possible to avoid delays in the provision of water and electricity later).
- Plan waste collection locations and required waste separation and composting areas.



#### Technical:

- Check whether you need to develop a new layout plan or if a former plan is still useable or valid.
- Make the layout plans flexible for future extensions, new accesses and necessary adjustments due to changes in the users' needs and habits.
- Ensure access through adequate roads and public transport system.
- Consider minimum distance between water wells and septic tanks. The minimum distance is 15 to 20m. (See also section on Water supply and Sanitation).
- Consider the new settlement's distance to the next village/town (for shopping and job opportunities).
- Assess communication needs (i.e. telephone).



#### Economic:

- Use land efficiently to preserve or enhance its economic potential.
- Ensure that the distance between houses meets the needs of the residents, e.g. whether they need

a garden, private outdoor space to dry clothes or grow fruits and vegetables, etc.

- Arrange streets and paths to economise on land use, while providing good access to houses and facilities.



#### Social:

- To extent possible, maintain existing social relationships within the community when resettling. The social network among families and within neighbourhoods is usually very important for the sustainable development of communities, including poverty reduction.
- Plan for neighbourhoods to include green and recreational areas.



#### Institutional:

- Comply with building codes, laws and regulations, such as maintaining:
  - o Minimum distance to neighbouring industrial areas and the airport
  - o Minimum sizes of the plots and their subdivisions
  - o Minimum distances between houses
  - o Minimum plot density (normally, the house should not cover more than 55% of the plot)
  - o Heights of houses, number of floors
  - o Purpose and usage of houses
  - o Street width (6-9 m, depending how many plots are to be accessed)



### How to do an EIA:

The Environmental Impact Assessment is an indispensable tool for identifying and minimising/avoiding a project's potential negative environmental. EIAs consists of three steps:

1. Information collection through site visits, interviews with local residents and experts, and data collection from authorities and expert organisations. The EIA should at a minimum describe:
  - o disturbances to sensitive and/or protected flora/fauna;
  - o release of pollution to air and water, and generation of waste during the houses' construction and use;
  - o access to water and the capacity of water resources to provide sufficient volumes for the needs of the households;
  - o noise disturbances; and
  - o potential measures to minimise any negative effects (based on technical and economic evaluations)
2. Verification of the EIA findings through public consultations with concerned stakeholders (local populations, future tenants, authorities and concerned NGOs).
3. Decision on whether the project is environmentally acceptable and, if so, what measures shall be taken to minimise negative impacts.

### Reuse and Recycling of Temporary Shelters

Temporary shelters can be reused when they are still in good condition. Temporary shelters, therefore, should be planned and constructed to allow them to be either integrated into, or disassembled/recycled for use in, the final buildings. This would require a well-developed site plan, indicating the permanent plots. Plots should be large enough to accommodate one family on a long-term basis. One option is to install the temporary shelter at the back of the plot, so that construction of the permanent housing can be carried out. The temporary shelter could be reused as an annex, storage, or bathroom. This approach would require a robust temporary structure and already-prepared infrastructure (sanitation, pipes, latrine, etc.). Another option is to provide a solid foundation with a ground floor slab where the temporary shelter is built so that it can be reused later for the permanent house.

### Rules of thumb - How to select the best flooding response strategy:

- Access ways to houses have to be safe and waterless.
- Flooding response strategy should not create any unwanted water ponds.
- Any land fillings or new dams should allow running off of water from heavy rains or tidal waves.
- Houses should be elevated (but avoid complicated stilt constructions).

## 3.4. Sustainable house design

House design is the core issue of every sustainable reconstruction project.

An important aspect of a sustainable house design is the extent to which the house can accommodate user needs, climate conditions and local natural hazards (e.g. earthquakes, floods, and storms). Well-designed houses minimise environmental impacts and risks, while meeting user needs. The choice of cooling, solar and ventilation systems, for example, has a direct impact on a house's energy efficiency and conservation.

Key sustainable house design recommendations are:

- Favour solutions that are environmentally sustainable and energy efficient.
- Use house designs that are resistant to natural hazards, such as earthquakes and floods.
- When designing a house, consider its whole lifecycle: construction, maintenance, reuse, demolition and recycling phases.
- Consider flexible designs that are easy to upgrade and expand.

- Use designs and materials that allow for easy recycling.
- Favour simple, low-cost, robust and practical solutions.
- Ensure easy maintenance through the use of modest and basic house styles. In many cases, maintenance and later renovation turn out to be technically complicated and, therefore, more expensive. Materials and tools needed to work the materials should also be locally available.
- Ensure cost-effectiveness in all construction activities
- Incorporate the users' needs and cultural requirements

House design encompasses the house's shape, construction system, building components, building materials and infrastructure (e.g., water supply, sanitation, waste management, power system).

### 3.4.1 House shape

The shape of a house is crucial to ensuring that it is built sustainably. Certain house shapes can better minimise or withstand the impact of earthquakes, floods, tidal waves, storm-surges, cyclones and climate conditions. The checklist below contains the most important points to consider when thinking about sustainable house shape.





## Environmental-technical aspect



The shape of the house has an important effect on its stability. The following rules should be taken into account:

- The more compact the house's shape, the better its stability. A square shape is, therefore, better than a rectangular one, a circular plan better than a square one.

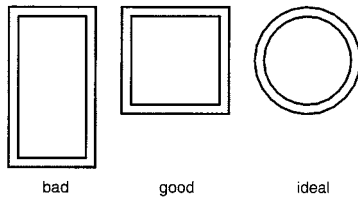

- L-shaped plans are less stable. An alternative is to separate house parts from each other, as shown in the picture.

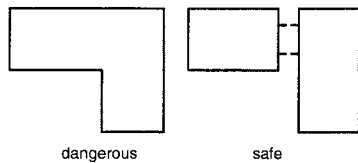

(Source: Minke, 2001)

- For better resistance to floods, consider elevating the ground floor and building an extra floor or using a flat roof that residents could flee to, if necessary. Flat roofs offer the added advantage of providing storage space for the residents' assets (e.g., grain, farming tools). A temporary or permanent protective structure (e.g., light roof construction made of wood or bamboo) can be built on top of the roof.
- To accommodate the local climate, research the climate zone in which the project will be located. If the project is sited in a warm-humid zone, use the natural airflow to lower internal temperatures and reduce the impacts of heat and humidity on the building and its users.

A number of steps can be taken to increase the natural airflow:

- The house's shape should be of 'open' character, allowing airflow through many openings, such as windows, louvers, and doors. Openings should be placed on opposite sides of the house to improve cross ventilation.
- Consider creating openings in the roof to enable warm and humid air to exit.

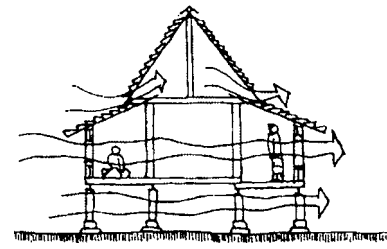

(Source: Astrand, 1996)

- Elevate the house from the ground to allow airflow underneath the building.
- Use detached or double roofing, which allows better air circulation and provides protection from the sun.

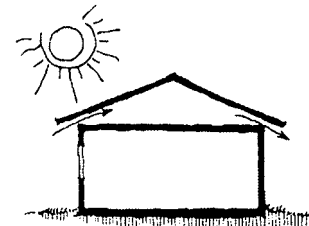

(Source: Astrand, 1996)

- When possible, place the houses with their longer axes to the prevailing wind direction in order to maximise airflow.
- Design houses with short building depth to allow wind flow throughout the house.
- Consider using large overhanging roofs, which provide good shading and protection against heavy rains.

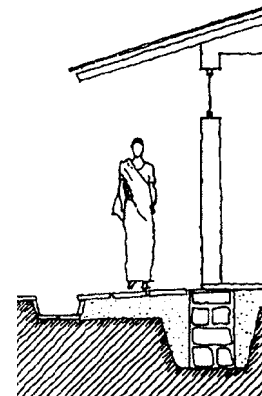

(Source: Astrand, 1996)

- In a rural setting choose light walls made of bamboo or wood, which store less heat than solid walls made of bricks, concrete or cement stones. Note, however, that light walls are less resistant to strong storms or floods as solid walls.
- The choice of building material determines the overall shape and flexibility of the house's plan/layout. Iron beams, for example, allow for larger rooms without additional support beams in between.

## 10 key principles of typhoon resistant construction

Some Tsunami reconstruction projects are located in typhoon-prone regions. The most important principles of typhoon resistant construction are:

- Use landscape and topography to protect the house.
- Simplify the house's form to minimise obstruction to the wind.
- Pitch the roof between 30° and 45° to lower wind suction.
- Separate verandas from the house's main structure.
- Tie the structure together firmly, and use diagonal bracing
- Attach the roof covering securely.
- Pay attention to the size and positioning of openings.
- Ensure that openings can be closed with outside shutters.
- Plant wind breaks in the form of hedges, dense trees, or other vegetation.

(Source: J. Norton in Development Planning Unit, 2001)

## Case-study: Aceh, Indonesia

"Transition" spaces between indoor house spaces and the outside space play a critical cultural role. In Aceh, for example, a high value is placed on informal living within the transition space, mostly during evenings when air temperatures decrease. The transition space may be a veranda, terrace, portico or porch.

## Case-study: Participatory decision-making during the design process Helvetas reconstruction project in Batticaloa, Sri Lanka

The management team in the Helvetas project developed the type and form of the houses in collaboration with the future users. Project managers can use simple techniques to help future users visualise the layout of the houses. The architect can lay the first layer of bricks or stones according to the actual size and shape of walls. Alternatively, he/she can span ropes between poles marking out the actual size of the planned walls. Large cloths or rags can be hanged so that users can imagine the size and shape of the rooms. Users can then express their ideas and needs, and determine the house's shape together with the project team.



### Economic aspect:

Construction costs can be minimised by using simple shapes without numerous and complicated angles. Sophisticated house shapes are normally more labour and material intensive.



### Social aspect:

To ensure a socially, aesthetically and culturally appropriate house design consult with the house future residents regarding which building form and layout will best suit their needs and fit with their customs. For example, it may be culturally required that the entrance face in an eastern direction; or that the kitchen be oriented to the south and be located beside the family room.

Sample questions for future residents include:

- Should the toilet be detached from the house or be integrated?
- What direction should the entrance or other key rooms face?
- How many sleeping rooms are required?
- Is there need for a religious space in the house?
- What other cultural requirements will the residents have concerning, e.g., privacy or religious practices? (Blinds, division walls, prayer corners, etc.)



### Institutional aspect:

It is essential to ensure that the shape, form and size of the house complies with national building codes and other laws and regulations, particularly with respect to anti-seismic or flood specifications.

## 3.4.2 Building Methods

Sustainable construction practices are low-cost, practical and environmentally appropriate. When selecting the most appropriate construction system, project managers should choose one that best suits local conditions, such as the availability of building material and skilled workers. Depending on local conditions project managers may want to choose from among the following sustainable building systems:



It is important that the house is adopted to local customs and needs. In many countries the traditional western style water closet is culturally less acceptable and more water and energy consuming than the locally traditional toilet is (picture)

*Prefabrication:*

Entire walls, floors and roofs are ready-made produced in the factory and shipped to the building site. Prefabrication allows for quicker and easier construction and can help to reduce labour costs and ensure quality control. Because construction with wall modules is rather complicated, good planning and organisation is essential. Skilled staff and special equipment are often needed. It is also important to ensure that prefabricated houses are designed to suit local conditions (climate, subsoil, culture, etc). For example, the routine for cleaning houses differs among cultures. It can be common to wash floors with a lot of water, in which case floors and the lower parts of walls must be designed to withstand water. In too many instances prefabricated houses

that don't meet this basic requirement have been exported to developing countries.

*On-site construction:*

All raw materials and construction products are transported to the construction site for assembly. Some elements, such as windows or doors, may be pre-fabricated. Concrete elements used for the foundation, columns and beams can be produced on site. Individual elements should not weigh more than 150 kg so that three workers can move them safely. Concrete elements should be cast in wood or steel moulds. The on-site construction method is more labour intensive and it requires regular quality control on site. Raw materials should be available locally.

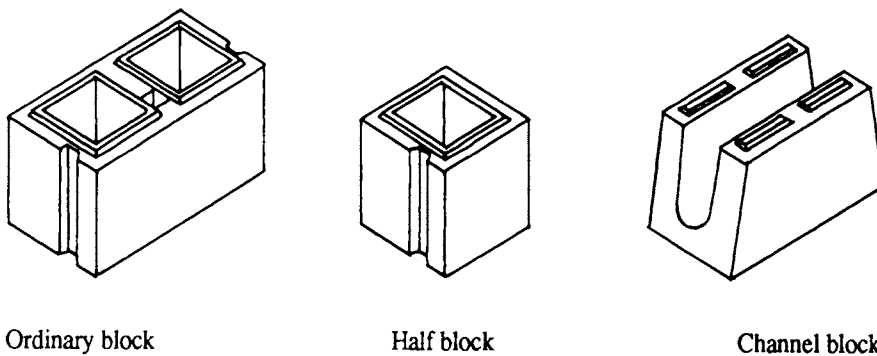

**Case-study:  
Mortar-free interlocking blocks system (LOK BILD System)**

The LOK BILD System was developed at the Asian Institute of Technology in Bangkok and has been tested in Malaysia, Thailand and the Philippines. The blocks are made of cement concrete in special moulds. The system consists of interlocking cement hollow blocks that are assembled without mortar, producing perfectly aligned walls. The system also includes pre-cast concrete beams, which interlock with the concrete block walls to support floors and roofs. Channel-shaped blocks are placed on top of the walls to form reinforced concrete ring beams. The concrete block's cavities are reinforced with steel bars and filled with concrete to provide earthquake resistance. The LOK BILD System provides highly stable houses that are suitable in all climates and have very good resistance to rain, hurricanes, floods, earthquakes and insects.

(Source: Skat)

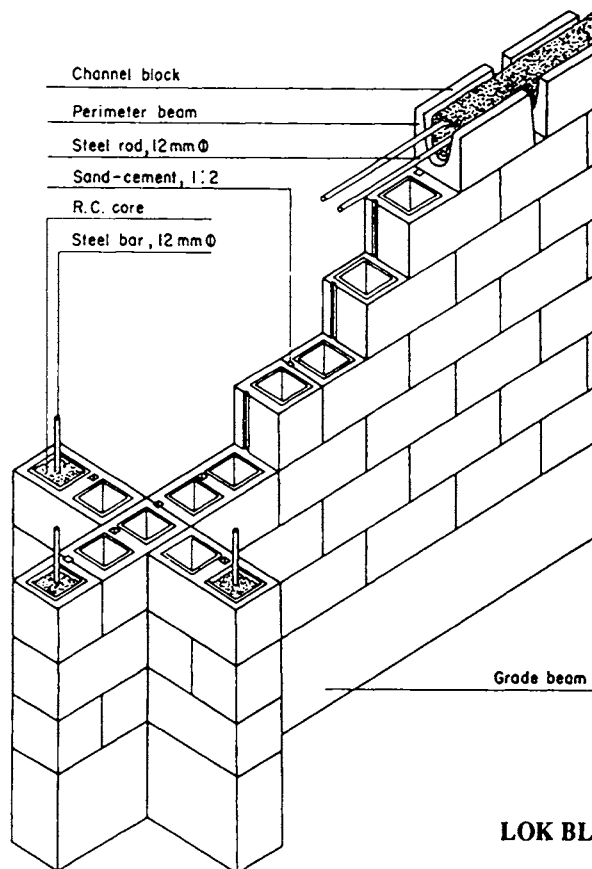

**LOK BLOK Assembly**

(Source: Skat)

### 3.4.3 Building components

The main building components are the foundation, supporting frames, floors, walls (with door and windows), ceiling and roof. Simple building techniques help to ensure sustainable reconstruction. Local workers will need to have enough skill to ensure that the houses are built safely and with good quality. If needed, additional training may be appropriate.

When assessing the building components to be used, the following steps are recommended:

- Check whether the material and technology can be used and understood by the local workers.
- Check whether special skills, experience or equipment are required.
- Assess whether repairs and replacements will be possible with local resources.
- When possible, select building components that are easy to disconnect in order to enable future recycling and reuse.

#### Foundation

The quality and life span of a house depends to a great extent on how the foundation is made. A poor foundation can soon lead to damage and deterioration that is difficult to repair. The type of foundation to be used should be selected early in the planning process, because it will influence the house's overall design. Key criteria for consideration when selecting a foundation include ground quality, which can be determined through a soil investigation; the house's anticipated load, i.e., its weight when fully occupied; and the availability of equipment and skilled workers.

Pad footing

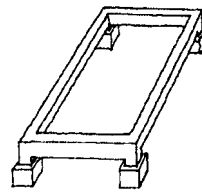

Strip footing

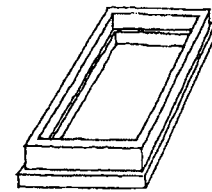

(Source: Astrand, 1996)

#### Construction System of Houses for Flood Areas CTA, Paraguay

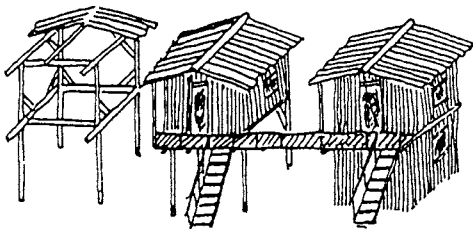
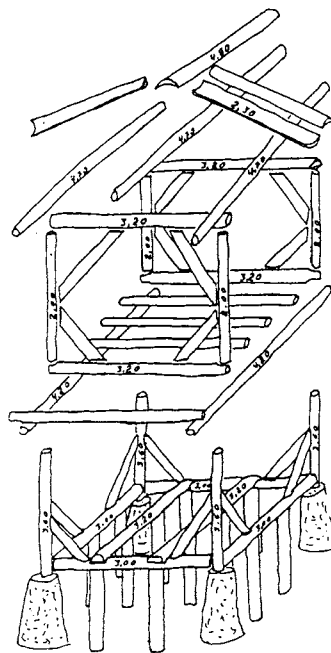
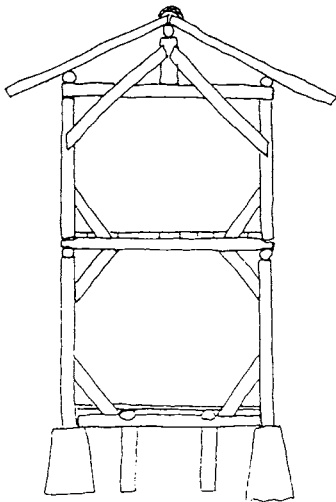

Grouped houses  
with escape platforms

#### Case-study: Timber houses for flood areas

Great floods in the 1980s in Paraguay led to the development of elevated timber houses that provide safe shelter even if floods rise up high enough to submerge single-story houses. The key design criteria are protection and escape from floods, low building costs, use of local materials and techniques, and suitability for self-help construction. A two-story house with an external stairway and a platform around the upper floor meets these criteria. During floods, residents can take refuge on the rooftop. Wooden boards can be laid between neighbouring houses to serve as bridges. Local timber can be used for the framework, walls, windows, doors and roof truss. Joints need to be well secured in order to ensure earthquake resistance, and foundations need to be very solid. Elevated timber houses are stable, provide good resistance to rain, hurricanes, floods and earthquakes, and are well suited to warm, humid climates.

(Source: Skat)

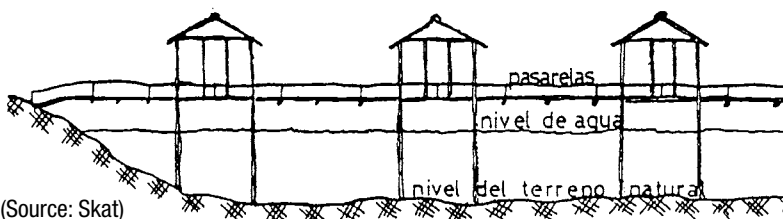

(Source: Skat)



### Design tips for earthquake-safe foundations

- Check soil type and water level.
- Assess soil strength for seismic design of foundations in accordance with country codes.
- Avoid using isolated footings with no ties.
- Use reinforced concrete strip footings under load-bearing walls.
- Soft clays and loose-to-medium dense sand, which is waterlogged, may liquefy during an earthquake. Avoid building in such areas or seek expert advice on piled foundations and structural design.



SKAT

The ground under the building needs to be strong enough to support the building, even if it is flooded or exposed to earthquakes. A proper assessment of the underground and removal of overlying earth of poor quality is essential in all cases.

### Supporting frame

The supporting frame (“skeleton”) of a building is often subject to local traditions and preferences. In situations where access materials may be restricted (e.g., in the aftermath of the Indian Ocean tsunami) alternative frame systems may need to be considered. There are at least three basic frame systems:

#### *Concrete frame:*

Concrete frames are widely used in reconstruction. Columns and beams are cast together into a frame. Gaps are filled with bricks or blocks. Bricks of lower quality can be used as fill material for external and internal walls. Good masonry skills are required for this approach.

In order to withstand earthquakes and other natural hazards, strong connections are required between vertical steel-reinforced concrete columns and ring beams. (A ring beam is a horizontal beam that follows the shape of the house, so named because it would look like a ring if it were round. The roof often rests directly resting on a ring beam.) Also crucially important for earthquake resistance are robust connections between supporting walls and non-supporting walls. Unsecured walls may fall outwards.

#### *Timber frames:*

Timber frames are often more resistant to earthquakes and other natural disasters than concrete frames and are easier to work with. Adequate carpentry skills, however, are required. In a situation where timber is scarce or likely to come from illegal logging, timber framing is not recommended.

#### *Steel frames:*

Steel frames are primarily used for constructing larger houses. The material is very strong but is difficult to work with without specialised tools and expert knowledge. Because steel frames are typically quite expensive, they are not often used for single-family houses.

### Floors

The choice of floor (technology used and surface) depends on its intended use. Consider the expected load, wear and tear, cleaning manner, slipperiness and resistance to moisture and insects.

In hot and humid climates, direct contact of the floor with the ground does not provide good cooling.

To improve floor cooling:

- Raise the floor and ventilate the space underneath (minimum 30 cm above surrounding ground level). Elevated floors also help avoid moisture problems.
- Use a light material that does not store warm temperatures, such as wood.
- Houses elevated on pillars offer protection from floods but may be more susceptible to earthquakes.

To improve earthquake resistance, consider the following measures:

#### Concrete floors

- Anchor concrete ground floors into the foundation and the concrete wall columns.
- Suspended concrete floors should be fixed securely on their upper and lower sides to the concrete wall columns.



'Rat trap bond' masonry is a cost-effective method, reducing consumption of bricks and mortar.

#### Timber floors

- Each floor beam should be secured fastened to the ground beam with metal straps.

#### Walls

The construction technique used for walls depends on the number of floors, the anticipated loads, and the risk of cyclones or earthquakes. The choice is also influenced by the building material to be used and availability of skilled workers.

Walls should be adapted to the local climate and require as little maintenance as possible. In regions with heavy rains, extended overhangs should be used to protect outer walls.

Walls play a crucial role in a house's resistance to earthquakes. Earthquakes affect buildings mainly with horizontal forces. The main danger due to the horizontal movements of the earth is that building walls and, consequently, roofs might collapse. As a result, the main aim of constructing earthquake-resistant houses is to avoid walls being able to collapse and to ensure that the roof is well secured to the walls. In order to make houses as resistant to earthquakes, storms and floods as possible, the following measures are recommended:

- Ensure that walls are reinforced sufficiently. If possible, have a qualified engineer calculate the required armoring and control regularly the quality of installation on site.
- Make sure that ring beams are well connected in each corner and with the reinforcement of walls and columns.
- Experience has shown that walls made of cement or fired bricks resist floods much better than do mud walls.

#### Windows, doors and other openings

Windows and doors provide natural light, communication with the outside and ventilation. For climate reasons, generally, all kinds of wall openings are important to ensure good ventilation and cooling of the house.

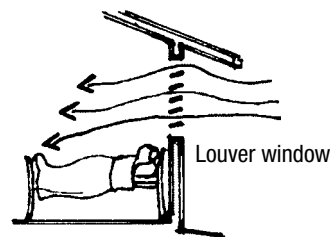

(Source: Astrand, 1996)

The following steps are recommended with regard to window orientation:

- Minimise direct exposure to sunlight.
- If possible, use trees to create additional shade.
- Locate windows toward prevailing winds and sea breezes for good cross ventilation and circulation.

In earthquake-prone areas openings in walls must be considered carefully as they destabilise the wall system, particularly in massive house styles (i.e., made of bricks, blocks, adobe, etc.). The following steps are recommended:

- Ensure that lintels penetrate the wall in order to achieve sufficient bondage (a lintel is a horizontal beam that usually supports the masonry above a window or door opening); or, better, use the ring beam itself as a lintel.
- The window's width should not exceed 1.20m and should not cover more than 1/3 of the wall's width.



- The length of walls between openings must be at least 1/3 of their height and must not be less than 1m.
- Generally, doors must open towards the outside so that residents can escape more easily in case of earthquake. A second door at the back of the house is recommended in case the main door is blocked.



(Source: Minke, 2001)

## Roof

The quality and state of the roof is extremely important. The roof protects against weather, wind, heat and cold. To some extent, roofs also protect external walls from sun and rain.

Traditional roofs (made of burnt clay, thatch or earth) require a lot of maintenance and are often not suitable in urban areas. In addition, thatch roofs are a fire hazard.

Flat roofs are critical in areas with heavy rains. Highly skilled workers, excellent quality building materials, and regular maintenance are required to keep flat roofs watertight.

For climate reasons, consider insulating the roof. Insulation reduces heat gain through the roof, keeping temperatures inside to a minimum. Overhanging roofs provide shade to walls and windows and are particularly useful to minimise the heating of sun-exposed walls.

In earthquake-prone areas roofs should be as light as possible. To achieve the best earthquake resistance, roofs should be well connected to all walls and columns. The supporting frame and pillars, however, should always be able

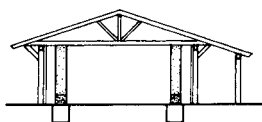
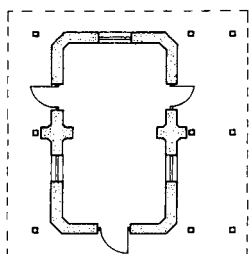

(Source: Minke, 2001)

to support the roof without the walls, so that even if a wall collapses, the roof does not fall down.

In cyclone-prone areas, roof slopes of at least 30° reduce wind suction forces. Strong connections of all roof components to the roof structure are required.

## Reuse and recycling of building components

Prefabricated wall components may be reused depending on their condition, required fixings and secure mounting.

## 3.4.4 Building materials

Building materials are either made from naturally available sources like inorganic materials (e.g., clay, stone, steel) or from organic raw materials (wood, straw).

The appropriateness of a particular building material can never be generalised. Whether a specific building material is sustainable or not, depends on the local context. For example, compressed earth blocks (CEB) might be appropriate in one setting but not in another, depending on the availability of soil of sufficient quality. The quarry of soil must also not jeopardize ecologically sensitive areas, agricultural lands or other livelihood sources.

The following summarises key issues regarding sustainable building materials:



### Environmental aspect:

An often-reported challenge is that suppliers sometimes deliver unspecified or illegally sourced timber to construction sites. The World Bank and Forest Watch estimate that Indonesia's annual timber demands is 73 million m<sup>3</sup>, while the potential legal supply is only 6 million m<sup>3</sup>. By this estimate, only about 8% of the country's timber is legally sourced. In addition, sources indicate that it is easy to obtain forged certificates of authenticity in Indonesia<sup>4</sup>. This example illustrates the importance of supporting the use of environmentally sustainable building materials in reconstruction activities. It is important, therefore, to:

- Avoid illegally logged timber and favour certified timber. Because timber certificates can be falsified, be careful to investigate the certificating authority's reliability and the authenticity of the certificate.
- Favour wood from plantations (managed by certified companies).

Concrete and brick production requires large supplies of sand, gravel, and appropriate clay. In the post-tsunami reconstruction process, when demand is high, many people are taking raw material from the closest riverbeds or mountains. Such practices are highly destructive and can have devastating effects, e.g., on wetlands, coral reefs or forest ecosystems.

To follow a more sustainable approach:

- Only use raw materials that are produced in an environmentally acceptable manner, and avoid using materials extracted from sensitive areas.
- Check the origin of sand. Avoid the use of coral sand and inappropriately quarried supplies.
- Find out whether quarry sites are rehabilitated afterwards.
- Investigate the purchasing policy or green procurement guidelines of your organisation, if they exist: the use of hazardous materials, such as asbestos, is not acceptable, nor is using unsustainably manufactured products, such as illegally logged rainforest timber.

The intelligent use of building materials can lead to a significant reduction in a project's environmental impact. Using local materials, for example, can minimise transport-related emissions. The use of local materials also helps to preserve local cultural identity and knowledge in project areas. In summary:

- Identify and verify that supplies and raw materials come from environmentally friendly practices and suppliers.
- Favour locally produced building materials.

In order to safeguard the health of the residents:

- Do not use toxic materials.
- Do not use materials containing chlorofluorocarbons (CFC), e.g., in refrigerators or air conditioners.
- Do not use asbestos.

For easier reuse and recycling of materials:

- Avoid sophisticated compounds and composites in building materials.
- Avoid complicated bonding agents and adhesives, when not necessary.
- Select building materials that are easy to disconnect and detach.

To save natural resources and energy:

- Check whether you can use recycled material.
- Find out if there is material available from demolished buildings nearby.
- Reuse tsunami debris, if is suitable: timber and roofing materials are robust and cost-effective materials that can sometimes be easily reused.
- Recycle tsunami debris: rocks, sand and concrete slabs can provide excellent fill for concrete if they are first washed, sorted and (sometimes) crushed/grinded to smaller fractions.

One result of the Indian Ocean tsunami is that large areas of land where settlements previously stood have sunk. Rebuilding in such locations should be avoided, but can still



Reconstruction in Banda Aceh, using locally produced bricks

be done if proper land filling is carried out. There is a risk that soil for land filling may be taken from foothills in secondary and tertiary forest areas. This needs to be monitored and managed to minimise soil erosion and impacts on vegetation and the landscape<sup>5</sup>.

To ensure more sustainable land fill:

- Check the origin of soil that is to be used for land filling.

### Case-study: Compressed Earth Blocks

To produce Compressed Earth Blocks (CEB), soil (raw or stabilised) is slightly moistened, poured into a steel press and compressed. Make sure that the soil is of good quality; it should not contain any humus or other organic materials that can decompose.

The usage of stabilisers (cement, lime, gypsum) will ensure a much better compressive strength and water resistance.

Advantages of CEBs:

- Good thermal insulation.
- No wood is required in the production process.
- Very regular in size and shape.
- Lower production cost and energy input compared with fired bricks.
- Can be locally produced (less transportation costs and emissions).

## Asbestos risks and how to avoid them

Asbestos is a mineral that occurs in nature. It has been used in over 3,000 products, including a variety of building products, such as cement roofing sheets, insulation and pipe lagging, because of its high tensile strength, relative resistance to acid and temperature, varying texture and flexibility. It does not evaporate/dissolve, burn or undergo significant reactions with other chemicals, which makes asbestos very useful, but also non-biodegradable and environmentally cumulative.

Exposure to asbestos can cause lung disease and cancer, depending on the concentration in the air and the length of exposure. All forms of asbestos are carcinogenic, and no safe level of exposure is known. Fibrosis of the lungs due to asbestos is called asbestosis. When fibres penetrate the lungs and become lodged within the lung linings/pleurae, cancer of the pleura, known as mesothelioma, may develop. Some intestine asbestos cancer (stomach, pharyngeal, colorectal) has also been identified, due to ingestion.

The International Labor Organisation and the World Health Organization have called for a ban of the production of all types of asbestos, which kills over 100,000 people annually. Asbestos products are already banned in 40 countries, including all European Union states. Some donor countries, such as the

United Kingdom and Australia have prohibited the use of asbestos in their tsunami reconstruction projects. Countries in which ACM is being used should:

- develop certification/specifications for all ACM products;
- establish standards for the work environment;
- regulate asbestos handling, disposal, and toxicity testing, and the use of personal protective equipment.

The best and recommended way to avoid the risks and unnecessary deaths associated with exposure to asbestos is to avoid using building products with asbestos-containing materials (ACM). If ACM has already been installed, removal is not recommended. Instead, the materials should be encapsulated with paint and air quality should be monitored periodically.

In cases where ACM products are being used in the workplace, workers should be provided with personal protective equipment, including well-tested respirators, to ensure that no asbestos fibres can enter their lungs. The proper use of respirators requires training, maintenance and good storage. After work, washrooms should be made available, and workers should take showers. Clothing should not be brought home, but cleaned at the premises.



### Technical aspect:

Houses built with insufficient quality building materials, low-quality concrete or inadequate steel reinforcement were usually badly damaged by the Indian Ocean tsunami. Project managers should give special attention to using high quality building materials. Try to ensure that the delivered material is of good quality by regularly material testing the aggregates (sand and stone), water and cement used.

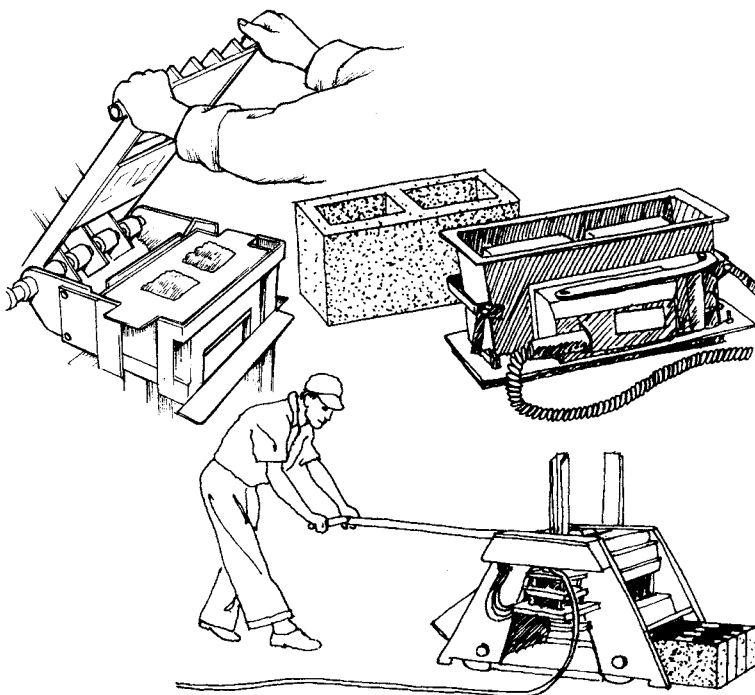

- Aggregates must be free from clay, loam, leaves or any other organic material. Clay or dirt coating on aggregates prevents adhesion of the cement to the aggregate, slows down the setting and hardening process, and reduces the strength of the mortar.
- Water should be of drinking quality without pronounced taste. Water containing salt (e.g. sea water) should never be used for mixing concrete as the salt reduces the strength of the concrete, and also corrodes steel reinforcement in the concrete
- The most common type of cement is ordinary Portland cement. Although freshly produced cement is normally of sufficient quality, it can lose quality through poor storage and transport.

### Case-study: Concrete Hollow Blocks

Concrete block construction has gained importance and has become a valid alternative to fired clay bricks. The essential ingredients of concrete are cement, aggregate (sand, gravel) and water. Concrete blocks are produced in a large variety of shapes and sizes. They offer a number of advantages:

- Good thermal insulation through their air cavity.
- No fuel or timber is required.
- They can be produced by small-scale to large-scale enterprises.
- They are lighter in weight.
- Construction of walls is easy and quick.
- Voids can be filled with steel bars and concrete, achieving high earthquake resistance.
- Cavities can be used for electrical installation and plumbing.



### **Economic aspect:**

The cost of building materials is often determines what type of materials are used. The cheapest materials, however, are not always the most suitable ones. Factors such as quality, durability, maintenance cost, and reliability of supply must also be taken into consideration. It is particularly important to consider the maintenance and potential repair cost of materials over the entire life cycle of the building in order to optimise overall long-term cost savings. Other important economic considerations that may affect the appropriateness of materials include:

- Using locally produced materials can save transport costs, strengthen the local material production industry, stimulate local job creation and avoid taxes on imported material.
- Production of building materials at the construction site is often cheaper than using prefabricated materials/elements and may also enable better quality control.
- Keep in mind that prices of building materials can increase suddenly, especially in post-disaster situations, where urgent demand often exceeds supply significantly. It is wise to plan for some financial reserves in order to avoid over-stretching the project budget.



### **Social aspect:**

In some cases residents have abandoned their homes because they did not feel comfortable with the materials used. Therefore make sure that users accept and feel comfortable with the construction materials chosen. To help ensure community satisfaction and the cultural appropriateness of materials:

- Consult with the community regarding whether certain materials are considered to be low standard or otherwise inappropriate.
- Assess whether local raw materials are being extracted or collected under safe and healthy working conditions.



### **Institutional aspect:**

It is crucial that the selected materials comply with relevant legal standards, national building codes and local regulations regarding safety, environmental sustainability, etc. To help ensure compliance:

- Use only earthquake proven and specified materials and related construction technologies.
- Check regularly the specifications and sources of delivered material.
- Reject materials, if needed.
- Support awareness campaigns focusing on the importance of using legal building materials.
- Maintain transparent dealings with suppliers at all times.

### **Reuse and recycling of construction materials**

The reuse and recycling of construction materials has to be considered carefully during the planning phase. Pure materials, like bricks, wood, concrete, stone, metal sheets are best to reuse or recycle. Concrete, used bricks and stones can be used as fill material to construct roads. Metal sheets and bricks can be used for fencing.

All types of composite materials (e.g., prefabricated solid foam-metal or foam-plaster elements) are difficult to separate and recycle.

## **Case-study: Sumatra**

Traditional rural housing schemes in Sumatra have mainly been constructed using timber, particularly in rural and more remote areas. In contemporary Aceh, however, there is a preference for using bricks as the principal building material. The proximity of Sumatra to a number of seismically active fault-lines means that the region is highly vulnerable to the impacts of earthquakes and subsequent tsunamis. In such an environment, timber construction using non-rigid joinery is most appropriate. In urban and peri-urban areas, however, there has been a major shift to the use of masonry as the major building material, with timber predominantly being used for roof, window and door frames, and floors. Although timber can be argued to be more appropriate climatically and more responsive to the prevailing conditions of earthquakes, there is a strong community perception that a masonry house is more permanent and requires less maintenance. Building with masonry is also perceived as “modern” or as a symbol of status and wealth.

Reconstruction programme managers need to be aware of this contemporary perception, particularly where alternative materials are being promoted. The introduction of steel and aluminium for roof trussing, and doors and window frames can provide an alternative to timber. The Research Institute of Human Settlements in Bandung, Java has developed an economical and innovative bamboo truss system, incorporating high-pressure treatment of the material to extend its longevity.



## Case study: Environment-friendly brick production – Vertical Shaft Brick Kiln technology (VSBK)

A Vertical Shaft Brick Kiln is an energy-efficient technology for fired clay brick production. The technology, which was originally developed in China, essentially consists of one or more rectangular, vertical shafts within a kiln structure. Rectangular arrays of dried green bricks and crushed fuel (coal) are carefully stacked into batches that are continuously loaded into the top of the shaft. As the batches gradually pass through the shaft the bricks encounter pre-heating, firing and cooling zones before they reach the shaft exit at the bottom.

### Benefits:

- *Energy Efficient:* The VSBK technology economises on fuel costs, with savings of between 30 to 50 percent when compared with other common brick-firing technologies (e.g., clamps or Bull's Trench kilns).
- *Economically Viable:* Brick production using VSBK technology is profitable and requires a low initial investment. The VSBK can be operated all year round: weather factors have only a minor influence, because a roof protects the kiln.
- *Environment Friendly:* Carbon dioxide emissions from a VSBK are 30 to 50 % lower than other kilns and suspended particulate matter, the principal cause of local air pollution, is reduced by up to 90 %. The construction of a VSBK requires very little land. Because VSBKs can only be fired with coal (or with coal dust), deforestation of rural areas and the use of waste such as tyres can be eliminated.
- *Uniform quality of production:* Unlike other brick-firing technologies that cannot produce fired bricks of uniform quality due to heat losses, VSBK fired bricks are 95% uniform and first grade quality.

(Source: Skat)



SKAT

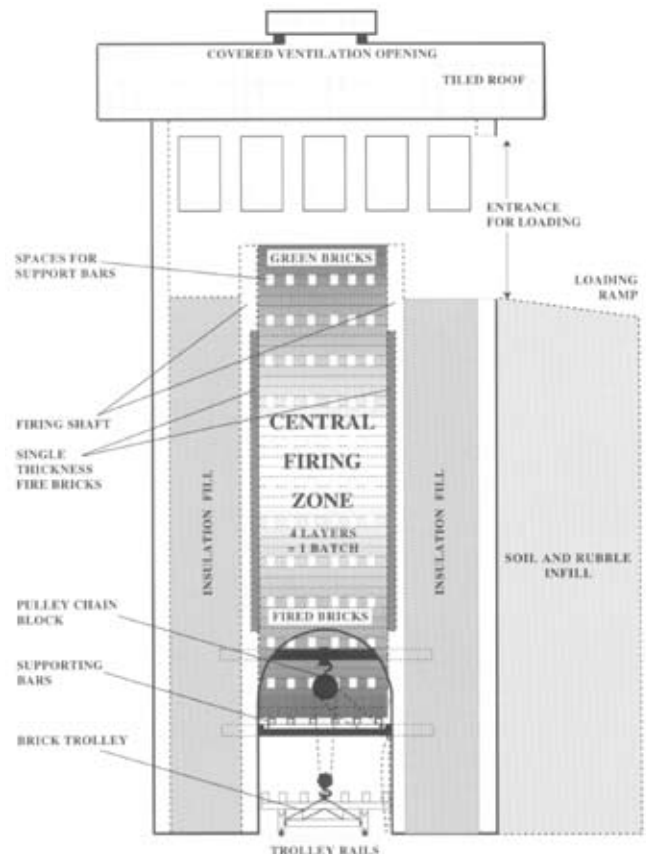

## 3.5 Services: Water, Sanitation, Waste and Energy

### 3.5.1 Water supply

Water is normally either provided through pipes from a communal water supply for the wider area or derived from local water sources for smaller units or individual households. There are three types of water sources that can be tapped: surface water, groundwater, and rainwater:

**Surface waters** include lakes, rivers, ponds and other open fresh water sources. Surface water is often the easiest water source to access. Surface water, however, is vulnerable to pollution and must thus be protected or treated. It can also be affected by wide seasonal variations in turbidity and flow.

**Groundwater** is found underground in aquifers, making it better protected from pollution than surface water but still susceptible to bacterial contamination from ineffective or disrupted sanitation systems and chemical pollution (e.g., fluoride, chloride, arsenic). Wells or boreholes are used to extract groundwater.

**Rainwater** can be collected from either an existing roof structure or a ground level catchment area and can provide a useful supplementary source of good quality water. Storage tanks are usually required to make the best use of rainwater and to protect it from pollution.

#### Example: Rain Water Harvesting

Rain Water Harvesting is a low-cost option for providing safe drinking water. In the Maldives, for example, the primary source of drinking water is rainwater stored in tanks. Approximately 75% of the country's population collects water from communal rainwater storage tanks or individual household tanks.

Rainwater harvesting systems require houses to have a tank with a lid, roof guttering and water saving plumbing. Rooftop catchments systems gather rainwater using gutters and down pipes made of galvanised iron (GI) or PVC, which lead it to one or more storage containers. The containers are simple pots or large ferrocement tanks. A detachable down pipe is fitted to exclude the first runoff during a rainstorm, which is usually contaminated with dust, leaves, insects or bird droppings.

Rainwater collected from roof-top catchments should not be considered a primary communal water supply but merely a supplementary supply that is particularly useful at household level.

Rainwater is normally soft, saturated with oxygen. Microorganisms and other matter suspended in the air are entrapped in the rainwater, but ordinarily these impurities are not significant. It is essential nevertheless that roofs, reservoirs and containers be kept clean in order to avoid any contamination of the collected water.

All rainwater collection systems should be equipped with filters on the inlet in order to prevent foreign bodies and contaminants from entering collection tanks. Regular maintenance is a must.

The operation of rainwater collection systems requires community education so that households will take responsibility for maintaining the quality of their supply by, e.g., cleaning gutters and sealing of tanks.

To meet current and future demands for clean drinking water, each household should be equipped with an individual rainwater collection system. This would increase overall capacity and decrease water supply vulnerability to future flooding.

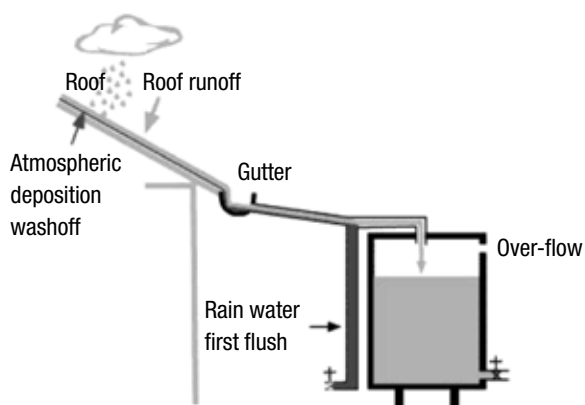

### Water treatment

Clean and safe drinking water is a necessity of life. Water sources, however, are often brackish (containing dissolved salts) and/or contain bacteria and, therefore, cannot be used for drinking. By testing water supplies through chemical/

physical analysis, it can easily and reliably be determined whether treatment is needed. Keep in mind that treatment processes are often expensive and normally require regular attention. Specialists should help communities decide which treatment methods are to be used.

### Example: Solar Distillation

Distillation is one of many processes that can be used for water purification at household level. Distillation, however, needs much more energy than pumping water and is, therefore, normally considered only where there is no local source of fresh water that can be easily accessed.

Solar distillation uses sunlight as the energy source. In the distillation process, water is evaporated, thus separating dissolved matter from water vapour that is condensed into pure water.

One option for the household level is the single-basin still. Solar radiation is transmitted through a glass cover. The radiation is absorbed as heat by a black surface that is in contact with the water to be distilled. As the water is heated, it gives off water vapour. The vapour condenses at the glass cover, which has a lower temperature because it is in contact with the outside air, and runs down a gutter into a water storage tank.

To treat larger drinking water quantities (more than 1m<sup>3</sup>/day) reverse-osmosis should be considered as an alternative to solar stills. A sophisticated version is the photovoltaic powered reverse osmosis system, which requires commercially available equipment.

Seawater reverse osmosis uses a very fine filter membrane that allows pure water to pass through, but captures salt particles. The seawater is pressed through the membrane, against the natural osmotic pressure (hence the name 'reverse osmosis'). The process requires energy input. Photovoltaic-powered reverse osmosis systems derive energy from solar panels fed with sun radiation. This system is still experimental, however, and requires further development.

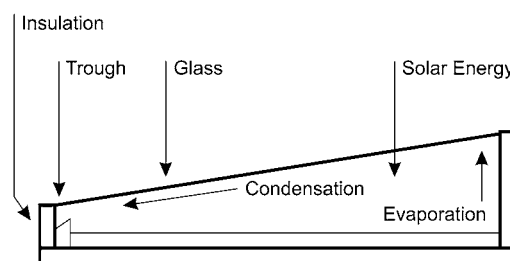

### Desalination

Desalination plants can consistently supply high water quality. Desalination, however, is an expensive option and has much higher operation and maintenance requirements than, for example, rainwater harvesting and groundwater extraction. The overuse of desalination can also have the long-term effect of encouraging mismanagement and depletion of groundwater reserves.

## Water distribution

Once a water source has been identified and developed, some means of delivering the water to its users must be found. Generally, water should be provided as close to individual homes as possible. Several factors must be taken into account in deciding on a water distribution method. The levels of service are as follows:

- Level 1 (individual water systems): Water must be transported from the source to each house, and distribution points are protected at the source.
- Level 2 (communal watering points): Provides water at one or more spots serving several homes. The method of distribution may be a water pipeline or a tank truck. Individuals carry water from the distribution points to their homes.
- Level 3 (community water distribution systems): Water is distributed to each house by a pipeline.

The higher the level of service, the more expensive the system will be to construct, operate and maintain. Higher-level systems, however, provide greater potential for improved health, and reduce or eliminate the need for water carrying so that people have more time for other activities.

If piped water is not available or an option, consider wells with hand-pump systems or electrical pumps with a manual back-up system. There are a wide variety of hand pumps available for different groundwater depths. Usually, the groundwater tables in tsunami-affected areas are quite high due to the land's low elevation and proximity to the sea.

Specific considerations for the design of water supplies include:



### Environmental aspect:

- Water resources are normally continuously replenished. If too much water is withdrawn, however, the source may eventually be depleted. For this reason it is very important to manage water resources and protect them from over-exploitation. Demand management measures (water tariffs, leak control, water-saving technologies and re-use) are effective ways of preserving overstressed water resources.
- If the distance between a groundwater well and the sea is short and groundwater is pumped at too high a rate, there is a risk of saltwater intrusion into the groundwater. Wells too close to the sea should, therefore, be avoided, and withdrawal of water from such wells should be controlled.
- In order to reduce the hazard of contamination (e.g., through floods or accidental spills of toxic substances), wells should be well covered or sealed with a lid.



### Technical aspect:

- Consider seasonal fluctuations in water sources (rivers, lakes) and ensure that water withdrawal does not exceed the source's capacity at the minimum water levels.
- Water distribution designs should be simple, user-friendly and easy to maintain.
- Water supply systems will stand a better chance of being used in a sustainable manner if they are built and maintained with local material and know-how, which the users can afford and know how to apply.
- Avoid placing water supply systems (pipes, etc.) in locations where the water might easily be contaminated if the system damaged, e.g., just next to sewage pipes.
- It can be a good idea to put up signposts around water sources, prohibiting people from dumping waste or otherwise contaminating the area.



### Economic aspect:

- Financial planning for water distribution systems has to account for initial investment costs as well as the management, operation, maintenance, replacement and extension/upgrading of services, including long-term support services. The responsibility for servicing the system and paying associated costs should be clarified from the outset.
- Select an approach to developing the system that is affordable and acceptable to system users.



### Social aspect:

- The form and design of water use in households is culturally conditioned. In many countries, the water supply is mounted outside the house. In other countries, there is only one single tap in the entire household, while still others have highly elaborated and distributed water access points for different functions and in different designs throughout the house (in bathroom, kitchen, and toilets). Learn the users' preferences before designing the system.
- The design of water supplies is sometimes gender specific. Do not forget to identify any specific requirements from the users in this aspect.



### Institutional aspect:

- Water supply systems can be operated privately, by the public, or as public-private partnerships. The formal arrangement and responsibilities for cost sharing costs, etc. must be defined from the beginning.
- If there are many users of the same water source, a common management strategy is required.
- Appropriate regulations should govern land use near water sources to ensure protection of the supply.

## 3.5.2 Sanitation

Sanitation and wastewater can be divided into latrine wastewater (also known as “black water”), other domestic wastewater (“grey water”), typically coming from cleaning and washing, and “storm water”, which is rain water that is collected from the roof and hard surfaces around the building. Black water is the most challenging to dispose of in an acceptable way, as it contains high levels of organic pollutants, often contains harmful bacteria, generates a foul smell, and, if left unattended, attracts flies and pests. Grey water, on the other hand, can often be reused for, e.g., irrigation or outdoor cleaning.

In more developed areas, black water is transported to a central wastewater treatment facility, where it is treated before being released. Very often, however, black water commonly comes flows from pour-flush latrines and cistern-flush toilets into septic tanks, and, to a lesser extent, into holes in backyards. Septic tanks are usually a combination of small-scale pre-sedimentation tanks and soak pits from which sewage migrates freely onto the ground. The most widely used small-scale sedimentation tanks can typically hold 1 to 2 m<sup>3</sup> of black water, providing one household with suitable capacity for approximately 6-10 months, after which it requires maintenance and sludge removal. In many cases, however, tanks are sealed or are located under topsoil, making regular maintenance nearly impossible. Also, tanks are often too small to provide adequate retention time and settling. As a result, most of the untreated sludge moves directly into soak pits and, from there, sometimes into fresh water resources, causing contamination.

Alternatives include:

- **Simplified sewerage** is an off-site sanitation technology that removes all wastewater from the household environment. Conceptually, it is the same as conventional sewerage, but with conscious efforts made to eliminate unnecessarily conservative design features and to match design standards local situations.
- **Settled sewerage** is a means of conveying domestic sewage that has settled in a septic tank or solids

interceptor tank – only liquid (water) flows through the system. This design approach is 20-50% more economical than conventional designs that require a given velocity at peak flow for self-cleansing. Settled sewerage requires, however, that only connections from septic tanks are made to the settled sewer, and that septic tanks are regularly emptied in order to prevent solids from passing through the tank into the sewer and become blocked. Settled sewerage is the preferred solution where functioning septic tanks already exist.

In some cases, septic systems are connected to small-bore sea outfalls. These systems are often poorly designed and inadequately maintained. As a result, they often malfunction and release raw sewage directly into the sea. Sewage treatment systems are generally scarce.

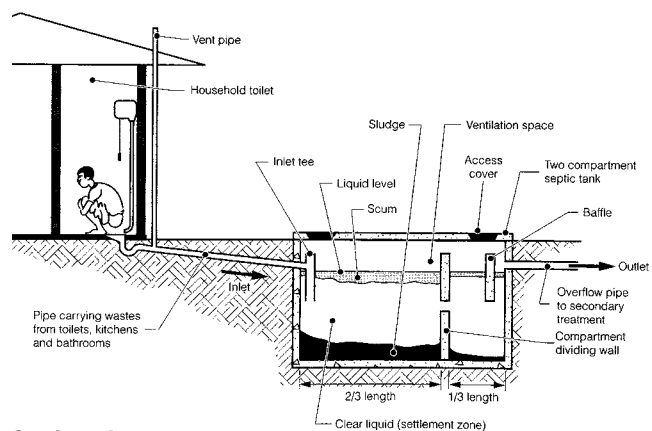

### Septic tank

A septic tank is designed to collect and treat toilet wastewater and other grey water. Septic tanks are used where the volume of wastewater is too large for disposal in pit latrines.

(Source: Harvey, P., 2002)

Sanitation and wastewater often constitute an urgent problem in disaster-struck regions. Groundwater under or near a pit or septic tank may become polluted, which can be a serious problem when it affects the quality of drinking water drawn from nearby wells and boreholes. Disrupted sanitation, or the lack of proper sanitation to begin with, can result in epidemics of cholera and other diseases. A particular concern in reconstruction projects is the possibility that latrine pits and shallow wells will be installed in close proximity on neighbouring plots.

### Selecting the sanitation method

When selecting a sanitation method the following considerations should be kept in mind:

- **Need:** What systems still exist from before the tsunami disaster happened? Can these still be used?
- **Social acceptability:** Will the proposed method of disposal violate local customs, taboos, or preferences? Is the method likely to be properly maintained? Have residents indicated that they prefer this system or, at least, are willing to try it?



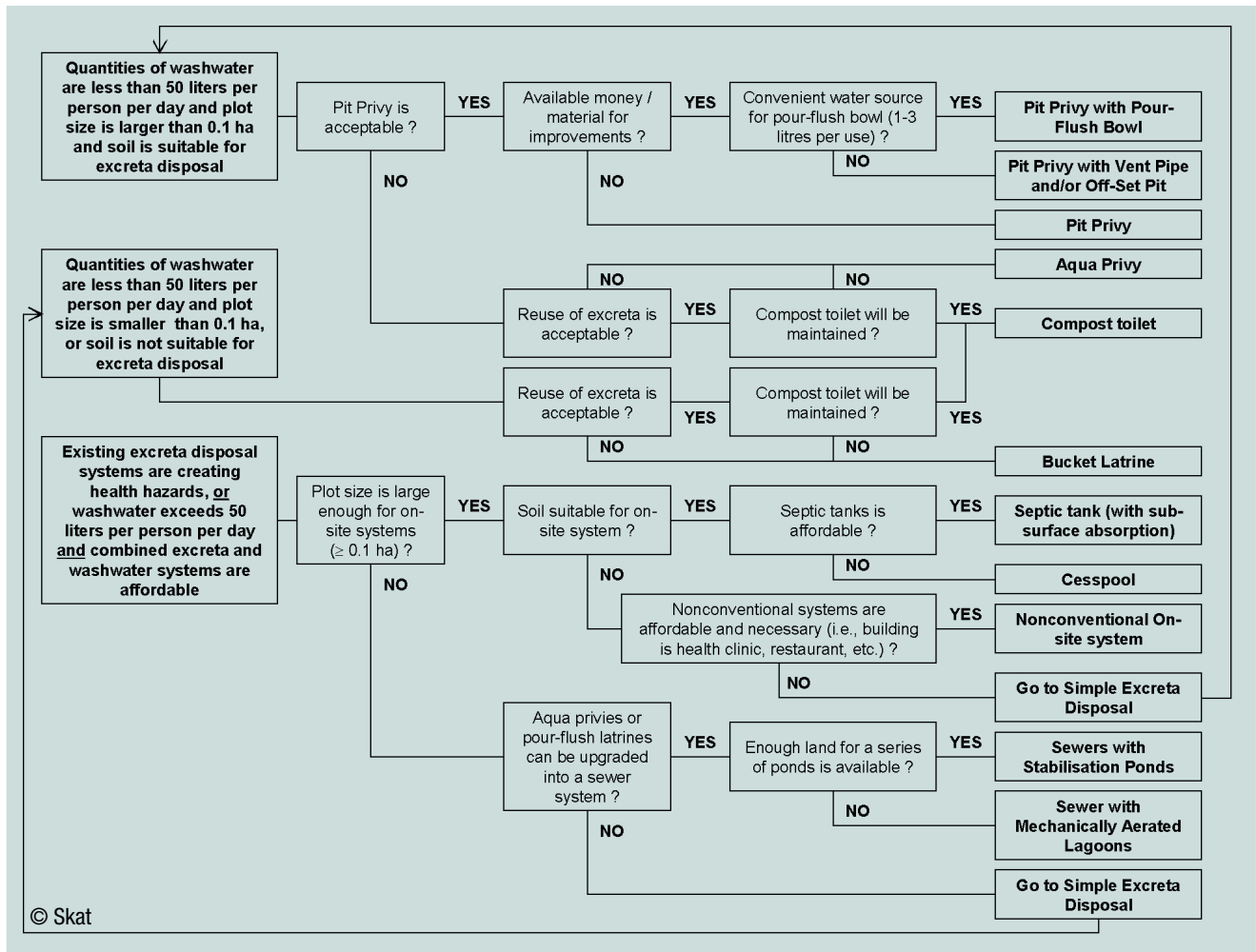

- Resources: Is the desired method practical considering available money, materials, and workers? Is the regional or national government likely to provide monetary or other assistance?
- Geography: Are soil conditions and groundwater levels acceptable for the desired method?
- Plot size: Is the plot large enough to support an on-site system (at least 0.1 hectares)?
- Wash water: Is the quantity of wash water generated more or less than 50 litres per person per day?

The diagram above helps in selecting an appropriate sanitation method (by Skat).

### Simple methods of faeces disposal

Simple methods of faeces disposal, such as using a pit or bucket to hold the faeces, are easy to build, inexpensive and can be made from locally available materials. These methods reduce the risk that water supplies will become contaminated and that diseases will spread. They also help protect public health by keeping animals and insects away from excreta.

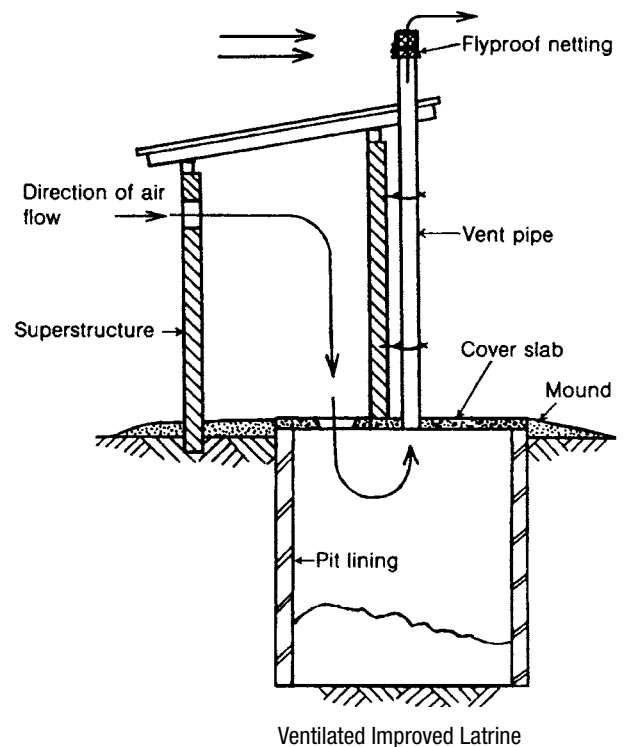

	Pit privy	Pit privy with improvements	Aqua privy	Compost toilet	Bucket Latrine
Cost	None	1½ times pit privy	2 times pit privy	2 times pit privy	No construction cost, but operation may be costly depending on community
Design Features	<ul style="list-style-type: none"> <li>- Pit</li> <li>- Slab (squat or seat)</li> <li>- Lid</li> <li>- Shelter</li> </ul>	Same as pit privy plus either pour-flush bowl, vent, pipe, off-set pit, or combination	<ul style="list-style-type: none"> <li>- Vault</li> <li>- Slab (squat or seat)</li> <li>- Shelter</li> <li>- Soakaway</li> </ul>	<ul style="list-style-type: none"> <li>- Double vault</li> <li>- Two slabs (squat or seat)</li> <li>- Shelter</li> </ul>	<ul style="list-style-type: none"> <li>- Platform</li> <li>- Slab (squat or seat); bucket</li> <li>- Shelter</li> <li>- Large containers cart</li> </ul>
Construction Skills	Minimal	Minimal	Some masonry	Some masonry	Minimal
Slab Material	Bamboo, wood, or concrete	Bamboo, wood, concrete, ceramic, or plastic	Concrete	Concrete	Bamboo, wood, or concrete
Water Requirement	No	No, except for pour-flush	Yes	No	No for operation, but yes for washing at trenching ground
Handling of Wastes	None	None	Every 2-6 years as sludge	Every 6-12 months as compost	Every 1-3 days as excreta
Maintenance	<ul style="list-style-type: none"> <li>- Clean slab weekly</li> <li>- Dig new pit and move slab and shelter every 4-6 years</li> </ul>	<ul style="list-style-type: none"> <li>- Same as pit privy</li> <li>- If off-set pit, clean chute weekly and dig new pit every 10 or more years</li> </ul>	<ul style="list-style-type: none"> <li>- Maintain water level in vault</li> <li>- Clean slab weekly and dig new pit every 10 or more years</li> </ul>	<ul style="list-style-type: none"> <li>- Clean slab weekly</li> <li>- Alternate use of vaults every 6-12 months by removing compost, cleaning one vault, sealing the other</li> </ul>	<ul style="list-style-type: none"> <li>- Clean slab weekly</li> <li>- Remove excreta every 1-3 days</li> <li>- Clean buckets every 1-3 days</li> <li>- Cart excreta to trenching ground and bury it or to composting area</li> </ul>

**Composting toilets** are used for home composting of human excreta. The design of such toilets includes two chambers, each capable of holding at least one year's deposit of excreta. No water is added to the chamber, but ash or sawdust can be added to improve the carbon: nitrogen ratio, which enhances the compost process and reduces smell. Compost latrines decompose excreta. When the first chamber is full, it is sealed. This allows for the composting process, which produces rich, pathogen-free compost that will increase agricultural yield. When the second chamber is full, the first chamber is emptied and the cycle process restarts.

Compost toilets can be constructed above ground or one meter deep in sub soil formation. They provide a cheap and relatively labour-free option. Only the regular emptying of pits every one to three years is required.

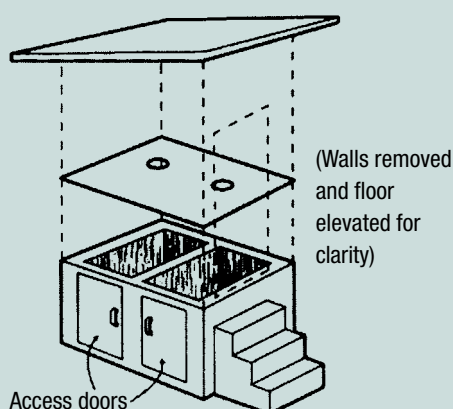

### Reusing grey water

Grey water, which is generated from processes such as washing dishes, other kitchen wastewater, laundry and bathing, comprises the majority of residential wastewater. The lack of proper sanitation can result in epidemics of cholera and other diseases. Because it contains little or no pathogens and 90% less nitrogen than black water (toilet water), it does not require the same treatment process. By designing plumbing systems to separate it from black water, grey water can be reused for irrigation and exterior washing without pre-treatment. It is important not to store to use grey water immediately to avoid degradation of its quality. The benefits of reusing grey water include reduced water consumption, a lower load for septic tanks or treatment plants, less energy use, and good plant growth. When planned for a new house, the home's wastewater treatment system can be significantly reduced, resulting in cost savings and a lower impact on the environment because water is conserved.

Considerations for sustainable wastewater systems include:



### Environmental aspect:

- Avoid placing sanitation systems upstream from fresh water sources.
- Septic tanks need to be placed at least 5-20 m away from the nearest water supply, 3 m from the nearest house, and 3 m from any property line.
- Soak pits or infiltration trenches (only for grey water, without faeces) should be at least at a 30m horizontal distance from any groundwater source.
- The base of any soak pit should be at least 1.5 m above the water table.
- Disposal sites should be downhill of groundwater sources.
- Untreated sewage must not be discharged into any fresh water source (lake, river, groundwater) or into the sea.

### Rough estimate of wastewater (grey and black water) generation per household:

The amount of wastewater household's produce is approximately 80 – 90% of the volume of fresh water they consume.

#### Septic tank dimensions:

For one household of 8-12 persons will need a septic tank of 2m<sup>3</sup> (1.8 x 0.8 x 1.4 m).

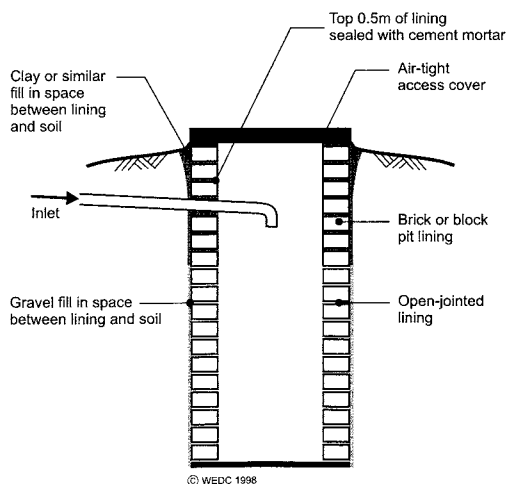

### Soak pit

A soak pit (or soak-away) is placed in the ground. It infiltrates wastewater into the surrounding soil. Soak pits are only appropriate where there are permeable ground conditions, a deeper water table, and the pit can be located a safe distance to any fresh water source. (Source: Harvey, P., 2002)



### Technical aspect:

- Ensure that septic tanks are easy to access for sludge removal and maintenance.
- It is important to ensure the storm water drainage is adequate. The lack of adequate or properly maintained storm water drainage systems can result in flooding and associated side effects.
- Wastewater may not flow into public drains.
- Discharge of untreated sewage into the sea is not acceptable. Outfalls for post-treatment residual fluids should be adequate distances from shorelines and villages, with consideration of tides, currents, etc., to safely dilute discharges.
- Ensure that all necessary pipes comply with required standards, including the minimum inclination to allow flow of wastewater.
- Consider the separation of black water from grey water, to minimise the volumes that will need more extensive treatment.
- Consider recycling grey water.



### Economic aspect:

- Financial planning has to account for initial investment costs of sanitation systems and their management, operation and maintenance. Who will manage the system and pay associated costs should be clarified from the outset.



### Social aspect:

- Pay attention to traditional and culturally accepted practices for handling waste.
- Programme managers should consider the availability of local skills and knowledge, and assess training needs.
- The design of sanitation facilities is sometimes also gender specific. Do not forget to identify any gender-specific requirements from the users.



### Institutional aspect:

- Decide what system will be used: a centralised public system or decentralised household-managed systems.
- Decide who will be responsible for managing the system and for paying associated costs.

### Vegetated leachfield:

In Aceh, a basic solution has been applied, since a centralised waste water collection and treatment system would not reach all households. A basic solution consists of a waterproof septic tank (made from prefabricated concrete or fiberglass) in combination with a vegetated leachfield. That leachfield treats wastewater by removing organic material and reducing nitrate and others. Once treated the water can be disposed to a river or sea.

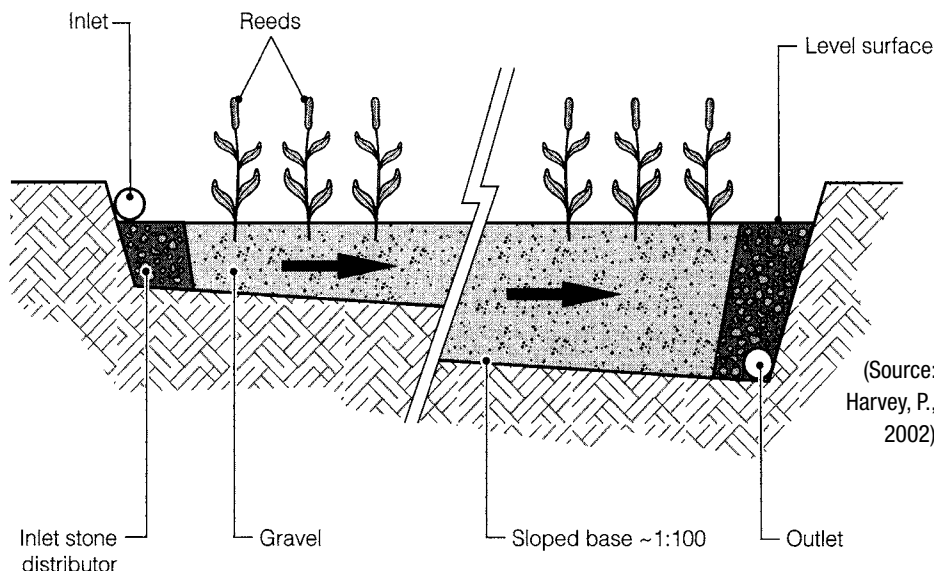

(Source: Harvey, P., 2002)

### Draft guidelines for the selection and implementation of sustainable sanitation systems across Aceh and Nias, Banda Aceh, November 2006, prepared by GTZ in cooperation with Oxfam, UNORC and UNICEF

A random sampling of reconstruction projects shows sanitation and drainage standards, in general, remain very low. Current installations are contaminating ground and surface waters and they are creating extensive breeding habitat for disease vectors. The costs of poor sanitation are unacceptable while the benefits of better sanitation are substantial. It is fair to say that the Millennium Development Goals (MDG's) will not be met in Banda Aceh unless reasonable standards of sanitation and drainage are implemented as a priority.

Implementers are encouraged to develop systems that best suit the individual situation of the reconstruction project. To protect public health and the environment, all systems have to adhere to basic sanitation standards: 1) no untreated wastewater is to be released into public drains; 2) all systems have to consist of primary and secondary treatment steps as a minimum; and 3) septic tanks have to be watertight. The recommended systems are designed for areas with *high groundwater tables* and require only *minimal maintenance*. *Operating costs* are low in order to ensure long-term functioning of the system. On-site treatment systems can realistically be installed to an acceptable operating standard with *minimal quality control*. Typical implementation costs lie within a range of *Rp. 6 mil and 9 mil*. Designs can often be individual or communal.

#### Description of modules

**Septic Tank** - a watertight receptacle constructed to promote separation of solid and liquid components of wastewater to provide limited digestion of organic matter, to store solids, and to allow clarified liquid to discharge for further treatment and disposal in a soil absorption system. Open tanks ("soak-aways") are not septic tanks. If transported and installed with care prefabricated systems will remain watertight and durable, and are highly recommended.

**Vegetated Leachfields** - A vegetated leachfield is an open system in which primary-treated wastewater is distributed through a horizontal perforated pipe laid in a gravel bed. The gravel bed is densely planted with fast-growing plants, which can be effective in harvesting nutrients.

**Subsurface Flow (SSF) Wetland** - A more effective secondary treatment system consists of a watertight subsurface flow wetland. Properly designed, this configuration can meet international standards for on-site treatment.

**Community Sanitation Centers** - A sanitation facility consisting of a number of toilets, bathrooms, and a washing/water tap area shared by many households. Treated effluent quality should meet local environmental standards and the Ministry of Environment's domestic waste standards.

**Centralized collection and treatment systems** - An alternative to on-site treatment systems are systems with centralised collection of wastewater and treatment in a communal treatment facility. Although large-scale implementation might not be possible, these systems may be feasible in carefully selected locations.

**DEWATS Sewage and Wastewater Treatment System** - This system collects black water and grey water directly from 20–100 households. The wastewater is being transported in a sewerage system to a decentralised, modular treatment facility. The DEWATS system can be completely built underground, making it suitable for areas where land is not available for sanitation systems. Treatment efficiency is very high, and maintenance is minimal, but communal management is required.

**Vacuum-pumping system** - A form of wastewater collection and transmission from several individual households to a central treatment facility. Sewage and wastewater flows by gravity to an individual or shared collection tank. When properly installed and managed the system is robust and has low operation and maintenance requirements, but it must be properly managed.



### 3.5.3 Solid Waste Management

Solid waste management is one of the most challenging environmental issues in tsunami-affected regions. Waste disposal practices vary among areas, depending on access to disposal facilities, local tradition and the degree of governmental or municipal intervention. Quite often there is no regular and controlled waste collection at all. Existing laws, regulations and administrative arrangements concerning waste collection and treatment are often not put into practice. It is also common to find that lack of proper waste management is not perceived as a major problem. It is essential that all stakeholders gain awareness of the need for more sustainable approaches to waste management.

It is common to find that planners overemphasise the provision of waste management infrastructure (e.g., trucks fleets, dumpsites) and neglect to plan how and by whom wastes should be segregated, collected, treated and disposed. A long-term support programme for waste management should be included in any reconstruction plan.

A major challenge of waste management are the disposal sites themselves, which are often uncontrolled, unmanaged and typically located along vegetation lines or shores, causing a pollution threat to rivers, natural water systems, and the groundwater. Impacts on ground water supplies, the coastal zones and reefs are quite evident. In the absence of alternatives, residents often burn their waste in the gardens and backyards of their houses, causing local air pollution, smell and health hazards from the production of dioxins and other toxics.

Waste materials are generally not segregated at the source. Where markets for recyclables exist, it is more likely that segregation is being done at household level.

In order to meet waste management challenges, the following steps are recommended :

- Solid waste management should be approached in a holistic way. Settlement planning, community organisation, administrative framework, water resources management, environmental protection and resource recovery aspects should all be fully considered.
- A good starting point is to assess the strengths and weaknesses of the former waste management system and identify how it can be built on.



#### Environmental aspects:

- Consider activities that will raise environmental awareness among families and facilitate the introduction of environmental friendly, healthy, effective, efficient and sustainable waste management systems.
- Ensure that waste is only deposited on designated sites, which are chosen to minimise the risk of

water pollution, uncontrolled burning, access of animals, vector proliferation and the scattering of waste by the wind.

- Locate disposal sites downhill from groundwater sources.
- Locate sites at least 50m from surface water sources.

#### Rough estimate of solid waste generation per person:

Each person is likely to produce 0.5 – 1.0 litres of waste per day with an organic content of 25 – 35 %. These figures are likely to vary greatly, however, and estimates should be made locally.



#### Technical aspects:

Selected waste management solutions must be practical and easily manageable under local conditions. Technologies used should be gradually upgraded. For example, it is often better to organise primary collection with locally available means of transport, such as handcarts, horse-drawn carriages or tractors with trailers, instead of relying on costly and maintenance-intensive specialised equipment like compactor trucks. Likewise, to build a fully engineered and controlled sanitary landfill with leachate control and landfill gas recovery may be the optimum solution, but in order to eliminate uncontrolled burning and dumping on the shorelines, the designation of smaller dumpsites on carefully chosen, easily accessible locations may be a better approach to improving conditions until a more comprehensive long-term solution can be implemented.

- Provide drainage trenches downhill of landfill sites on sloping areas.
- Secure and fence off disposal sites.



#### Economic aspects:

- A good starting point is to assess the strengths and weaknesses of the former waste management system and identify how to build on lessons learned. Recyclables such as metals, paper and plastics should systematically be collected and marketed. Sometimes, this is economically unattractive for a single household, but may become interesting if organised on community, village or city scale. The organic fraction should, to the extent possible, be used at household level as animal feed or for composting. Where this possibility does not exist, separate collection and treatment of the organic or 'wet fraction' will allow the production of compost and reduce the amounts of residual waste that has to be hauled

to the disposal facility and associated costs. Consider low-cost, affordable waste management technologies and systems.

- If properly organised, waste management can become a source of income for small transport entrepreneurs or community-based enterprises.
- As an incentive to reduce waste, to raise awareness, and to ensure regularity and quality of collection and disposal services, at least a part of the costs of solid waste management should be charged to the residents.



### Social aspects:

- Assess which solid waste management system the residents and the responsible institutions are accustomed to: collection at household level or at centrally located collection sites within a neighbourhood? The best results in waste management are achieved if the community assumes it as their own interest to use the system. Explore, support and promote community participation in all aspects of the planning, organisation, implementation, supervision, and financing of waste management activities.
- Effective solid waste management in a village or city can only be achieved if all parties, i.e., all citizens at all income levels, are served by

the system. If restricted municipal budgets, accessibility limitations or incapacity to pay service fees exclude part of the households from proper waste management, environmental and health improvements in other neighbourhoods will remain at risk. Therefore, mechanisms to attain full coverage for all social groups must be sought.



### Institutional aspect:

- Assess all stakeholders and their real and potential responsibilities regarding waste management.
- Consider the local administrative and political situation.
- Review local legislation and regulations on waste management.
- Assess who owns the proposed site for waste disposal.

There is no ready-made solution for solid waste management that fits every situation. Each set of local conditions may well have different requirements, and the right solution for a given place and time will have to be sought. As many desired improvements are related to people's awareness, habits and customs, a practical and realistic step-by-step approach involving as many stakeholders as possible is more likely to bear more cost-effective and appropriate results than centrally planned proposals based on technology inputs and huge investments.

## Sustainable Composting

Composting is an option to treat organic waste in a sustainable manner.

The main forms of organic waste are household food waste, agricultural waste, human and animal waste. Up to 60% of all municipal waste is organic. Organic waste can be used for soil improvement, animal feeding, and as a source of energy (e.g., biogas).

Composting is a process that converts the organic part of solid waste into a humus-like product. The process breaks down organic waste within a large container or heap. Composting occurs through active microorganisms that exist in nature, such as bacteria and fungi. Small earthworms and millipedes help to complete the process. Composting can convert organic waste into rich humus (compost) within 2-3 months.

### Benefits:

- Composting saves valuable landfill space and prevents possible contamination of land and water.
- It can be used as a soil conditioner / fertiliser on farmland and in the garden.

A number of composting options exist:

Backyard composting at household level is a simple to organise - it only requires suitable organic waste and a space to construct the heap.



Neighbourhood composting, which involves long heaps, is also a commonly used technique. Waste is spread out in long rows and turned occasionally. This requires reliable and regular waste collection and community members interested in using the produced compost for their gardens or fields.

Composting has clear benefits in terms of solid waste management, resource recovery and environmental protection. The viability of compost production as a commercial activity on a larger scale, however, is frequently overestimated.

The location of disposal sites should be determined through consultation with key stakeholders including local authority officials, families' representatives, and relevant organisations. Appropriate locations should avoid negative community impacts from smell, smoke, water pollution, insects and animals.

### Communal pit disposal (on-site disposal)

One of the simplest solid waste management systems is where residents dispose waste directly into communal pits. The recommended size of communal pits is 6 m<sup>3</sup> per 50 persons. Pits should be fenced to prevent children from falling in. They should be located not further than 100 m from the houses to be served. Waste should be covered at least once a week with a thin layer of soil to minimise flies and other insects. Communal pits can be rapidly installed, and need little effort to operate and maintain. Waste workers, however, are required to maintain pits regularly.

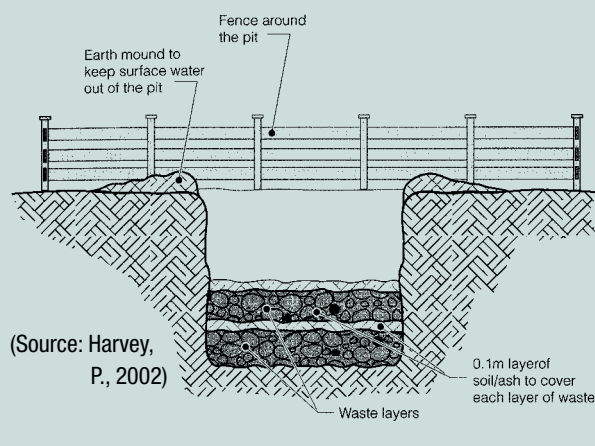

### 3.5.4 Sustainable energy systems

Households use energy for cooking, lighting, heating/cooling of air and water, for powering refrigerators and other household equipment, and often also for other electric equipment such as TV, radio and computers.

By tradition energy is either supplied as electricity by the power grid, smaller diesel-powered electricity generators or the use of gas, coal or firewood (for heating purposes). These energy sources, however, are becoming increasingly expensive and, in the case of coal or firewood for heating, may also pose an indoor health hazard.

As far as possible, energy consumption should be reduced through good planning and building design, and by making use of renewable energy sources, such as solar, wind and small-scale hydro power, geothermal and bio-power mass energy systems. The benefits of using renewable energy include long-term competitive price stability, reduced vulnerability to fuel supply disruptions, and minimised emissions of greenhouse gases. The Maldives provides an example of a country that is highly dependent on oil (nearly 100%). As a result, the country is very vulnerable to oil supply

disruptions and price fluctuations. Because the country straddles the Equator and has consistently strong sunlight, an alternative is to generate electricity through communal or individual photovoltaic panels to meet future energy needs.

Renewable energy can often provide electricity and hot water to isolated, low-density areas that are often too expensive for conventional energy system power lines to reach. Reconstruction projects in remote areas offer opportunities to conserve energy and to provide underserved areas with sustainable power systems. Renewable off-grid power systems may also provide significant cost advantages. In many cases, renewable energy resources are abundantly available in disaster-affected regions.

The most relevant sustainable power systems with regard to reconstruction are:

**Solar energy** can be used to provide lighting, mechanical power and electricity. Sunlight is converted to electricity using photovoltaic (PV) cells, also known as "solar cells" or "solar panels". Photovoltaic cells produce electricity as long as light shines on them, they require little maintenance, do not pollute and they operate silently. A reliable supplier of solar panels and appropriate installation is required. Prices for solar panels can differ from region to region.

Solar panels can be easily installed on roofs or be placed beside houses.



Solar rechargeable lanterns provide a temporary, flexible and low-cost lighting option. They come in kits consisting of a photovoltaic panel, a lantern containing a high efficiency lamp, a rechargeable battery and a charge control circuit. The concept is simple: during daytime, sunlight falls onto the photo-voltaic panel, generating electrical voltage that charges the lantern's battery so that the lamp can provide light during night time. A charge control circuit inside the lantern ensures that the battery is charging and discharging. The lantern also provides DC power output, enabling it to power a radio or other small appliances.

## Biogas

Digesting human, animal or vegetable waste in specially designed digesters produces biogas. The scale of simple biogas plants can vary from a small household-based system to large commercial plants. Biogas can be used for many applications, including lighting, cooking, electricity generation and as a replacement for diesel in engines. A further benefit is that waste is reduced to slurry with a high nutrient content, which is an ideal fertiliser.

In Sri Lanka, Practical Action (formerly ITDG) has helped to commercialise new biogas schemes. Biogas plants collect cow dung from adapted cattle sheds, mix it with water and channel it into fermentation pits. The resulting gas is fed directly to the households to provide energy for cooking, laundry and lighting. The biogas plants also produce organic waste that is dried and used as fertiliser.

## Wind power

Small-scale wind power plants can provide a good additional energy supply for individual households in areas with adequate wind conditions. Like PV cells, wind plants cannot operate in all weather conditions, but can, e.g., be used to charge batteries for later use.

Issues to consider for sustainable energy systems include:



### Environmental aspects:

- A well-designed house can typically reduce energy consumption by 30% or more by favouring natural ventilation, cooling and lighting.
- Renewable energy systems save natural resources, reduce indoor and outdoor pollution, and are often cheaper to operate than conventional (oil, gas, coal) systems.



### Technical aspects:

- Reconstruction offers a good opportunity to install renewable energy systems, especially when the systems can be installed in a large number of houses at the same time.
- Select the renewable energy system most suitable for the area of reconstruction. National meteorological organisations usually have maps and data available to estimate how many windy days or sunny days the area has in a year.
- Some renewable energy sources (wind, solar) should have a conventional backup system for days with unsuitable weather conditions.



### Economic aspects:

- Renewable energy solutions are often more expensive to purchase and install than conventional sources. Because renewable energy is virtually free, however, the economy of renewable energy sources over the life span of the building is normally much better than conventional systems.
- Reconstruction projects involving a large number of houses can purchase energy systems, such as PV cells, in bulk orders at much discounted prices. Alternatively, houses could jointly invest in a common larger renewable energy system.



### Social aspects:

- Sustainable power and renewable energy systems must be well adapted and sensitive to users' culture.
- Cooking and heating with fuel wood or coal can cause serious indoor pollution with associated health problems. As far as possible, avoid these kinds of energy sources for indoor use.
- Training is necessary for the construction and maintenance of alternative energy solutions.



### Institutional aspect:

- Some governments are actively promoting renewable energy sources and providing incentives (e.g. soft loans, tax reductions) for users to install such systems.

## 3.6 Construction

The construction phase is in many ways the most important stage for the total sustainability of the house. Not only can many disturbances be generated from the construction itself, but also the house's long-term sustainability depends on whether the sustainable features of the house design are implemented effectively during the construction stage. A sloppy construction phase can, for example, result in malfunctioning ventilation, energy or water systems, in buildings with sub-standard foundations, making them vulnerable to flooding and earthquakes, or in houses that are difficult and expensive to maintain, and more expensive to build.

The monitoring and evaluation system developed in the project design should therefore be strictly implemented. Any deviations from the plans or standards should be corrected without delay.



Another important aspect of the construction phase is management and minimisation of construction waste. A certain amount of construction waste will unavoidably be generated. It is important to have a system for handling that waste. A 'site waste management plan' assists in identifying the volume and type of construction and demolition waste, and sets forth how waste disposal will be minimised and managed. Because construction waste can often be recycled or reused, the separation of different kinds of waste is recommended.

Likewise, waste remaining on the building site from buildings and infrastructure crippled in the disaster should be handled carefully, removed and transported to an interim storage area at a location identified and agreed with community leaders.

Donor organisations and reconstruction contractors need to coordinate tsunami waste removal time frames in order to maximise efficiency and achieve adequate disposal.

Soil contamination during construction can be avoided through the appropriate storage of fuel and chemicals, e.g., in a secondary containment of fuel tanks and chemical containers.

Additional recommendations include:

- Minimise dust and noise emissions during the construction phase as far as possible through cleaning and covering the site and minimising wind exposure.
- Maintain good working conditions with effective health and on-site safety procedures. Provide workers with safe transport to the site and home if needed.
- Careful organisation of the transport of materials, workers, etc. to and from the site will lower emissions and save costs. Roads are often impassable during rain seasons. Many roads and bridges will not support heavy trucks. A good practice, therefore, is to ask for local advice when making transport plans.

### 3.7 Maintenance

Houses require regular maintenance, no matter where they are built or for how long they are intended to function. Maintenance requires regular inspection, economic resources and knowledge. It is a good investment to include a training component for maintenance in reconstruction projects. Maintenance might be impossible if a new material, that is not locally available, is introduced.

Because houses are exposed to weather and user wear and tear, abrasion starts immediately after construction. Individual components can stop functioning and cause damage to other components. A roof leak, for example, might result in water damage inside the house. Faulty components need to be repaired to avoid damages to the house and its residents.



Solid reinforcement of buildings with bars is a basic requirement to allow them to withstand future disasters, such as earthquakes and hurricanes.

SKAT

The most cost-effective strategy for keeping houses well functioning is to provide regular maintenance and repair defects while they are still small. Houses that are not maintained at all have only a limited life span. Good maintenance, on the other hand, can lengthen a house's life span substantially, thus saving resources and prolonging the time before the house will need to be partly or completely rebuilt.

Shortage of funding is often given as a reason for poor maintenance. Remarkable results, however, can be achieved with very limited financial means, if maintenance is regular and systematic. Very often, poor maintenance results from lack of awareness amongst practitioners and the house's users.

To ensure proper maintenance, the following steps are recommended:

- Analyse attitudes towards maintenance. Possibly the greatest challenge to establishing good maintenance is making involved stakeholders aware of its benefits. Find out the attitudes toward maintenance and habits of concerned stakeholders (users, house-owners, local craftsmen, contractors, and local authorities).
- Clarify who is responsible for maintenance and who controls its quality. How will it work in practice? What would hinder good maintenance?

- When handing over houses to users, provide basic training in maintaining the house. According to the users' level of knowledge, this may include information about general cleaning, small repairs, clearing gutters and storm water drainages, and how to use the toilet.
- Do not hand over houses unless all systems have been tested and confirmed to be functioning.
- Indicate to users that maintenance is needed continuously and without interruption in order to guarantee the houses' good functioning.
- Formulate minimum maintenance standards according to the house design and materials used. Technical specifications, drawings and other references to completed construction works can help in the creation of standards. A good question to ask when developing minimum acceptable house standards is: will it be sufficient to preserve the house shell against weather and theft or must comfort and a nice, clean appearance also be assured? The answer to this question will help determine the scope and efforts of maintenance and related costs.
- Clarify who will pay for any needed repairs and maintenance costs. Users, if possible, should assume responsibility if reasonably possible.
- Maintenance will be easier in houses with simple designs, good quality materials and sufficient standard of workmanship.
- Avoid complicated technical installations (plumbing, electric systems etc) so as to make any future repairs easier.

- If necessary, local craftsmen can be trained to seal leaking roofs, adjust locks and hinges, and replace water tap seals, broken window panes, etc.

A *list of maintenance priorities* given to the users or even developed by them will assist maintenance.

### Example of a priority list

#### Basic cleaning:

- Inside and outside of the house cleaning.
- Removal of debris from gutters and storm-water drains.
- Cutting of trees and bushes when growing too closely to the house, damaging surfaces or dropping leaves into gutters and onto roof.
- Cutting of grass, if needed.

#### Preventing water damage:

- Ensuring quick and free drainage of rainwater from the house and the site.
- Keeping roofs waterproof.
- Keeping installations waterproof.
- Securing foundations against erosion.
- Checking regularly foundations, floors, walls, ceilings for cracks.
- Cracks should be investigated to identify the causes. The causes of the cracks should be addressed and the more serious cracks be repaired by skilled masons.

Undertake regular bat, insect and micro-organism (fungus) control.

# Annex I

## Endnotes

- 1 Earth Summit (Rio de Janeiro), 1992; Habitat II (Istanbul), 1996; Summit on Climate Change (Kyoto), 1997.
- 2 This international panel, named after its chair, Norway's Prime Minister Gro Harlem Brundtland, was created in 1987 as one of several working groups in anticipation of the UN Conference on Sustainable Development in Rio de Janeiro, Brazil (1992).
- 3 Brundtland Commission, *Our Common Future*, 1987.
- 4 ADB-ETESP- Spatial Planning and Environmental Management, 2006, *Draft Guidelines: Environmentally Friendly Construction Material Procurement*, Asian Development Bank.
- 5 ADB-ETESP- Spatial Planning and Environmental Management, 2006, *Draft Guidelines: Environmentally Friendly Construction Material Procurement*, Asian Development Bank.

# Annex II

## References and links

- BASIN Building Advisory Service and Information Network  
<http://80.237.211.43/basin/>
  - BASIN South-Asia, Regional Knowledge Platform  
<http://www.devalt.org/da/tsb/basin/basinsouthasia/index.htm>
  - Development Alternatives Information Network  
<http://www.dainet.org/default.asp>
  - Development Planning Unit, 2001, *Implementing the Habitat Agenda-In Search of Urban Sustainability*, UK
  - Engineers Without Borders-International Networking Database  
<http://www.ewb-international.org/database/>
  - RISE-AT (Regional Information Service Centre for South-East Asia on Appropriate Technology)  
<http://www.ist.cmu.ac.th/riseat/links.php>
  - Skat (Swiss Resource Centre and Consultancies for Development), St. Gallen, Switzerland, <http://www.skat.ch>
- Planning and Construction**
- Astrand, J., 1996, *Construction in Developing Countries*, Swedish Mission Council, Stockholm, Sweden
  - Cuny, F., Thompson, P., 1981, *Economic Issues in Housing Reconstruction*, Intertect, Washington, D.C, USA
  - Davis, J., Lambert, R., 2002, *Engineering in Emergencies – A practical guide for relief workers*, ITDG/RedR, London, UK
  - GTZ- Deutsche Gesellschaft für Technische Zusammenarbeit, 2003, *Guidelines for Building Measures after Disasters and Conflicts*, Eschborn, Germany
  - Gut, P., Ackerknecht, D., 1993, *Climate Responsive Building-Appropriate Building Construction in Tropical and Subtropical Regions*, Skat, St.Gallen, Switzerland
  - HUDCO - Housing & Urban Development Corporation, 2001, *Natural Disaster Mitigation- Dos and Don'ts*, New Delhi, India
  - ITDG - Intermediate Technology Development Group, 2004, *Guidelines for planning in the re-building process-resource pack*, ITDG-South Asia, Colombo, Sri Lanka
  - Minke, G., 2001, *Construction Manual for Earthquake-Resistant Houses Built of Earth*, Gate-Basin/GTZ, Eschborn, Germany
  - Müller, H., 2004, *Basic Construction Training Manual for Trainers*, Skat Foundation, St. Gallen, Switzerland
  - Norton, J., 1998, *Woodless Construction-Unstabilised Earth Brick Vault and Dome Roofing without Formwork*, Lund University, Lund, Sweden
  - Patel, D. et al., 2001, *Repair and strengthening guide for earthquake damaged low-rise domestic buildings in Gujarat, India*, Gujarat Relief Engineering Advice Team (GREAT) Publication, Gujarat, India
  - Ruskulis, O., 1997, *The Basics of Concrete Building Products*, Gate-Basin; Braunschweig, Germany
  - Stulz, R., Mukerji, K., 1993, *Appropriate Building Materials*, Skat, St.Gallen, Switzerland
  - Twigg, J., 2002/06, *Technology, Post-Disaster Housing Reconstruction and Livelihood Security*, Disaster Studies Working Paper No. 15, Benfield Hazard Research Centre, London, UK
  - University of Moratuwa, 2006, *Proposal for Rapid Environmental Assessment on Tsunami Permanent Housing Sites in Sri Lanka (Questionnaire)*, Department of Civil Engineering, University of Moratuwa, Moratuwa, Sri Lanka

- Wates, N., 2000, *The Community Planning Handbook*, Earthscan, London, UK
- Whole Building Design Guide (WBDG), *Life-Cycle Cost Analysis (LCCA)*: <http://www.wbdg.org/design/lcca.php>

### Composting

- Practical Action (formerly ITDG, formerly Intermediate Technology Development Group), *Technical Brief on Recycling Organic Waste*, [www.itdg.org](http://www.itdg.org)
- Mansoor A. (ed.), 2004, *Sustainable Composting-case studies and guidelines for developing countries*, Loughborough University, UK

### Compressed Earth Blocks

- CRATerre-EAG, 1995, *Compressed Earth Blocks*, Vol. I, II, Gate-Basin; Braunschweig, Germany
- Auroville Earth Institute, (<http://www.earth-auroville.com>), Auroville, India
- CRATerre (<http://terre.grenoble.archi.fr>), Grenoble, France

### Desalination

- IDA (International Desalination Association) <http://www.idadesal.org/default.aspx>
- International Science Services <http://www.desline.com/proc-others.shtml>

### Grey Water Reuse

- <http://www.greywater.com/>
- <http://www.toolbase.org/Technology-Inventory/Sitework/greywater-reuse>

### Maintenance

- Carlqvist, B., 1998, *Maintenance of Institutional Buildings - A Management Perspective*, Lund University, Lund, Sweden

### Procurement of Construction Material

- ADB-ETESP - Spatial Planning and Environmental Management, 2006, *Draft Guidelines: Environmentally Friendly Construction Material Procurement*, Asian Development Bank, Manila, Philippines

### Project Management

- Bonwick, H. (ed.), 2005, *Protection - An ALNAP Guide for Humanitarian Agencies*, Active Learning Network for Accountability and Performance in Humanitarian Action, UK
- CIRIA Sustainable Construction Indicators Chart, CIRIA, UK ([www.ciria.org](http://www.ciria.org))
- GTZ-Gate, 1996, *Participatory Impact Monitoring*, Eschborn, Germany

### Roofing

- Stulz, R., 2000, Skat, *Roofing Primer - A Catalogue of Potential Solutions*, St. Gallen, Switzerland
- Skat (ed.), 1999, *Roof Truss Guide*, St. Gallen, Switzerland
- Skat, 1993, *The Basics of Concrete Roofing Elements*, St. Gallen, Switzerland

### Solar Distillation

- Practical Action (formerly ITDG), *Technical Brief on Solar Distillation*, [www.itdg.org](http://www.itdg.org)
- CREST, 2001, *Battery-less Photovoltaic Reverse-Osmosis Desalination System*, ([test.netgates.co.uk/nre/pdf/SP200305.pdf](http://test.netgates.co.uk/nre/pdf/SP200305.pdf))

### Sustainable Power Systems and Renewable Energy

- Practical Action (formerly ITDG), Rugby, UK, <http://www.itdg.org>
- International Solar Energy Society (ISES), Freiburg, Germany, <http://www.ises.org>

### Water Supply, Sanitation and Solid Waste Management

- Adams, J., 1999, *Managing Water Supply and Sanitation in Emergencies*, Oxfam, Oxford, UK
- Baumann, E., 2003, *Technology Options in Rural Water Supply*, Skat Foundation, St. Gallen, Switzerland
- Erpf, K., 2004, *Technology Selection – Buyer's Guide for Public Domain Handpumps for Drinking Water*, Skat Foundation, St. Gallen, Switzerland
- Franceys, R., 1992, *A guide to the development of on-site sanitation*, World Health Organization



- Fröhlich, U., 2001, *Management Guide Construction (Series of Manuals on Drinking Water Supply)*, Vol. 1, Skat, St. Gallen, Switzerland
- Harvey, P., Baghri, S., Reed, B., 2002, *Emergency Sanitation-Assessment and Programme Design*, WEDC (Water, Engineering and Development Centre) - Loughborough University, Leicestershire, UK
- Hebette, A., 1996, *Guide Pratique de la Gestion des Dechets Solides Urbains en Afrique Sub-Saharienne*, IAGU-Institut Africain de Gestion Urbaine, Dakar, Senegal
- Lifewater technical library ([www.lifewater.org](http://www.lifewater.org))
- Meuli, Wehrle, Müller, Pfiffner (Skat), 2000, *Building Construction (Series of Manuals on Drinking Water Supply)*, Vol. 3, Skat, St. Gallen, Switzerland

### Tsunami-affected countries

#### India

- Government of Tamil Nadu:  
<http://www.tn.gov.in/tsunami/default.htm>

#### Indonesia

- Building Code, Province of Nangroe Aceh Darussalam, Ministry of Public Works, Directorate General of Human
- BRR Policy Guidelines for the Provision of Resettlement Assistance to Victims of the NAD/Nias Tsunami and Earthquakes
- BRR Infrastructure Guidelines (issued draft 1, 15 September 2005)
- GIS and databank:  
[http://www.areas-tsn.net/Aceh\\_Disaster/](http://www.areas-tsn.net/Aceh_Disaster/)
- Gruber, P., Herbig, U., *Settlements and Housing on Nias Island Adaptation and Development* (paper), Institute for Comparative Research in Architecture, Vienna University of Technology; Vienna, Austria
- Indonesia Tsunami Relief Portal:  
<http://www.indonesia-relief.org/>
- Marulanda, L., Rizal, S., 2006, *Local Response – Indonesia*, Tsunami Evaluation Coalition (TEC)/ The International Community's Funding of the Tsunami Emergency and Relief
- Monitoring & Evaluation of Post-Tsunami Permanent Housing in Aceh & Nias, 2<sup>nd</sup> Round Program, UN-

Habitat, Urban Planning Laboratory of Unsyiah, and Aceh Institute

- Prices of Construction Material and Labour costs (Post Tsunami), Governor of Nanggroe Aceh Darussalam, Decree 050.205/082/2005 (27 May 2005)
- Reconstruction Master Plan for the Areas of Aceh, Nias and North Sumatra, Ministry of Public Works
- Regulation of Executing Agency (Nos. 18, 19, 20, 21), 2006, *Rehabilitation and Reconstruction Agency and the Lives of the People of Nanggroe Aceh Darussalam Province and Nias Island, North Sumatra Province*
- World Bank, 2006, *Aceh Public Expenditure Analysis*
- WWF (World Wide Fund for Nature) - Indonesia, 2005, *Green Reconstruction Policy Guidelines for Aceh*

#### Maldives

- United Nations, June 2005, *Maldives Sustainable Reconstruction Design Principles*
- UNEP, 2005, *Post Tsunami Environmental Assessment- Maldives*, United Nations Environment Programme, Asian Tsunami Disaster Task Force, Geneva, Switzerland

#### Sri Lanka

- Basic Guidelines for Planning, Design and Implementation of Cluster Housing Settlements, Ministry of Housing and Construction Industry, Eastern Province Education and Irrigation Development
- Guidelines for Construction in Disaster Prone Areas, published by the Sri Lanka Urban Multi-Hazard Disaster Mitigation Project; available from the Centre for Housing and Building (CHPB), 33 Sunil Mawatha, Pelawatta, Battaramulla, Tel. 011-2785628/9
- Information about the Coastal Conservation (Buffer) Zones (CCZ) can be obtained from the Tsunami Housing Reconstruction Unit (THRU) at the Urban Development Authority (UDA) and Coast Conservation Department (CCD), Tel. 011-2864160, 2875919

### 1. Environmental Management

- Project sites subject to an Environmental Impact Assessment (EIA) or Environmental Review (%)
- Regulatory enforcements action (fines/warnings) (No.)
- Complaints received from public (noise, dust, waste) (No.)
- Project sites that include renewable energy and/or energy efficient measures (%)
- Project sites that include hazardous building materials (such as asbestos cement sheets)(%)
- Project sites that use recycled materials (timber, brick, concrete) including former temporary shelters (%)
- Project sites that use timber from a certified sustainable source (%)

### 2. Biodiversity

- Project sites where biodiversity assessments have been undertaken (%)
- Project sites where habitats are restored/improved (%) and area (hectares)

### 3. Social Factors

- Proportion of women employed
- Health and safety accidents/incidents (%)
- Training on environment, health and safety provided to workers (%)
- Personal protective equipment provided to workers, at no charge (%)

### 4. Sustainability

- New homes that need to be remediated or demolished due to environmental factors (landslide risk, flood prone areas, lack of water/sanitation, sensitive biodiversity areas)(%)
- Project sites that include disaster risk reduction measures (for example, reinforced concrete ring beams in seismically active areas)(%)

---

<sup>1</sup> After CIRIA Sustainable Construction Indicators Chart, CIRIA, UK ([www.ciria.org](http://www.ciria.org)).

1) The regulations issued in 2006 concerning the Rehabilitation and Reconstruction Agency and the people of North Sumatra Province govern:

- Housing rehabilitation
- New housing construction
- Resettlement development in new locations
- Residence assistance

The regulations emphasise the need for not only reconstructing houses but also economic development and rehabilitating the livelihoods of disaster victims. Victims are defined as 'families who, until the disaster, lived in the disaster area, and lost their residence as a result of the disaster'. The regulations acknowledge the need for financial assistance to victims and emphasise that victims should play an active, integral part in reconstruction initiatives.

The regulations require that the implementation of housing and settlement reconstruction be based on a 'just, sustainable and community-based development approach', considering 'social, cultural, economic, and environmental factors'. Available funds must be used in a manner that is effective, optimal, transparent, and accountable.

The regulations indicate that the appropriate standard for house sizes is a minimum size of 36m<sup>2</sup> plus bathroom and kitchen. Beneficiaries may expand the houses with their own funds.

The issue of secure land ownership remains unresolved: 'land owned by victims whose houses were destroyed as a result of the tsunami disaster must be immediately made available for residential use'. The question of who will be the landowner of the new residences is not clearly answered.

The regulations further state: 'Victims who did not own their residence need to be empowered to become homeowners'. Real empowerment occurs, however, only in combination with secured land ownership. Home ownership alone is not sufficient to ensure secured shelter and sustainable livelihoods.

On the positive side, the regulations state that resettlements should be integrated with the surrounding environment.

2) The Building Code issued by the Ministry of Public Works covers spatial issues (spatial planning, space utilisation and its control) and architectural aspects (character of buildings, role of planners and architects, participation of users). The Code indicates the required setbacks from the sea and regulates where and what kind of buildings are allowed, including densities (minimum distances between buildings and number of storeys per building).

The Code specifies the minimal number of rooms per house: one bedroom, one family living/dining room and one kitchen. The Code also requires green spaces and vegetation, adequate road access, site plans, and the management of environmental impacts.

The structural and technical requirements of the Code for safe houses need to be more specific. Regarding the choice of building materials to be used, the Code states that 'asbestos cement board' is 'ideal roof covering'. As discussed in Chapter 3.4.4 above, asbestos-containing materials, such as asbestos cement board, raise a number of serious environmental and public health concerns and have been banned in many countries. Materials that do not harm nature and the health of residents should be strongly favoured.

The Code also gives guidance on water supply, sanitation, and waste management issues, as well as on licensing and permits.

<sup>2</sup> Regulation of Executing Agency (No. 18, 19, 20, 21), 2006, Building Code, Province of Nangroe Aceh Darussalam

# Annex V

## Assessment of strength of natural soils (not fills or organic clays/silts)

The table below provides guidance regarding how to assess the strength of natural clay or sand soils. Also included is an assessment of the allowable bearing pressures for shallow foundations on natural clay or sand. These are approximate values and will need to be determined by a site survey in

order to design the foundation. A site engineer should always provide advice on allowable foundation pressures.

Rock soil is generally acceptable for foundations of houses that are up to two storeys high.

Cohesive soils (clay)		
Consistency	Field assessment of soil strength	Typical values of allowable bearing pressure (kN/m <sup>2</sup> )
Very stiff	Indented by thumbnail; brittle or very tough	> 300
Stiff	Indented by thumb pressure; cannot be moulded in fingers	150 - 300
Firm	Moulded by strong finger pressure	75 - 150
Soft	Moulded by light finger pressure	35 - 75

Soils that are not cohesive (sand and/or gravel)		
Consistency	Field assessment of soil strength	Typical values of allowable bearing pressure (kN/m <sup>2</sup> )
Dense	High resistance to penetration by hand bar or pick axe	> 350
Medium dense	Difficult to excavate by shovel	100 - 350
Loose	Easily excavated by shovel; only small resistance to penetration by handle bar	40 - 100

(Source: Patel, D. et al., 2001)



Most countries have established quality standards for building materials, and in some cases producers of materials are required to provide certificates that the standards are met. Unfortunately it is quite common that such certificates lack verification or even are falsified (as is often the case of, e.g., certified timber). It is recommended that the quality of construction materials be assessed whenever its origin and quality is in doubt. Below are a few tips about how to assess materials when testing facilities are not available.

The recycling of materials can be a cheap and easy way of finding construction materials, and also generally a good environmental practice. The quality of recycled materials, however, should always be verified, as even high quality construction materials may be damaged in disaster situations.

### **Cement**

- When cement is rubbed between fingers and thumb it should feel like a smooth powder such as flour.
- Check the cement for any lumps and remove them.
- Never use cement that has been stored for more than six months.

### **Concrete blocks**

Good quality concrete blocks are produced and stored under a sunshade and have a cement to aggregate mix ratio of 1: 6-8, with clean raw materials (sand, gravel, drinking quality water) and fresh cement. Blocks should be properly cured for 21 days and handled with care until used for masonry work.

### **Fired bricks**

- The quality of a brick is good if there is a clear ringing sound when two bricks are struck together.
- A brick should not break when dropped flat on hard ground from a height of one meter.
- A good burned brick has a surface so hard that a fingernail cannot scratch it.

### **Sand and aggregates**

Dirty sand should never be used in masonry work because it will reduce the mortar's adhesive quality considerably.

To check whether sand is suitably clean, use the hand test: rub a sand sample between damp hands. Clean sand will leave the hands only slightly stained.

Or use the bottle test: Fill a bottle half way with sand. Add clean water until the bottle is three-quarters full. Shake the bottle properly and leave it for one hour. Clean sand will settle immediately. Silt and clay will settle slowly on top of the sand. The clay and silt layers' thickness should not equal more than 10 percent of the sand layer's thickness.

Sand from the sea is unsuitable for mortar as it contains salts, which influence negatively the mortar's moisture and overall quality.

### **Water**

- Water should be of drinking water quality and have no pronounced taste or smell. Seawater should not be used. Rainwater collected from roofs can be used for mixing mortar or concrete.
- Water mixed with any kind of oil should not be used for mixing mortar or concrete.
- Water should be stored to prevent it from becoming contaminated.

There are a large number of suppliers of sustainable building systems and building materials. The challenge is often to identify suppliers that can provide their products and services on short notice to the areas where reconstruction is taking place. The internet is an excellent source of information, and there are several sustainable buildings databases available.

Please note that this report does not endorse either the internet databases or the suppliers cited below. Contact details are given only as examples of information sources.

<http://www.greenbuildingpages.com/main.html>  
<http://www.greenbuilder.com/general/greendbs.html>  
<http://www.buildingmaterials.umn.edu/resources.html>  
<http://www.geocities.com/sustainabletech/building.html>  
<http://www.toolbase.org/ToolbaseResources>  
<http://www.sbis.info/>

A few examples of providers of the specific materials and systems referred to in this manual are also given below for easy access.

### **Compressed (Stabilised) Earth Blocks**

#### **Equipment to produce blocks (special press)**

Auroville Earth Institute  
Auroville, India  
Email: [earth-institute@auroville.org.in](mailto:earth-institute@auroville.org.in).

Development Alternatives  
Delhi, India  
Email: [tara@devalit.org](mailto:tara@devalit.org)

Parry Associates  
London, UK  
[www.parryassociates.com](http://www.parryassociates.com)

### **Interlocking Bricks**

#### **Equipment to produce bricks (special press)**

Domtec Company, Limited (Habitech Building System)  
<http://www.habitech-international.com/>

### **Micro Concrete Roofing (MCR) Tiles**

#### **Equipment to produce tiles (vibrating table, moulds, etc.)**

Parry Associates  
London, UK  
[www.parryassociates.com](http://www.parryassociates.com)

Appro Techno  
Cul-des-Sarts, Belgium  
[www.appro-techno.com](http://www.appro-techno.com)

### **Solar Rechargeable Lantern**

Sollatek Solar Systems (Glowstar)  
Slough, UK  
<http://www.glowstar.net/>

### **Solar Distillation**

SolAqua  
El Paso, Texas, USA  
<http://www.solaqua.com/solstillbas.html>

# Annex VIII

## Project environmental review record

1. PROPOSAL/PROJECT DETAILS – Project Manager to complete							
1a)	Proposal/Project Title:						
1b)	Implementing Agency:				Cluster Group:		
1c)	Work Stage	Proposal		Approved Project		Project No.	
1d)	Cluster Manager:				Cluster Manager Contact: Email		
					Cluster Manager Contact: Phone No.		
1e)	Project Manager:				Project Manager Contact: Email		
					Project Manager Contact: Phone No.		
1f)	Proposal/Project Summary (brief description of activities)						

2. PROPOSAL/PROJECT STAGE – Project Manager to complete			
			Action
2a)	Will the project result in physical, environmental or site disturbance ?	YES	Complete 2d).
		NO	You are proposing a project such as software development, routine inspection, non-intrusive monitoring, and training or the procurement of goods/equipment, complete 2b)
2b)	Will the project result in the procurement of goods/equipment to be delivered to impacted country ?	YES	Complete Section 7
		NO	Complete 2c)
2c)	Will the project involve training and capacity building in impacted country ?	YES	Complete Section 8
		NO	You are proposing a project with no potential environmental impacts, complete Section 9
2d)	Does the project comply with the Agencies own environmental policies and procedures ?	YES	Complete 2e).
		NO	Amend proposal to ensure compliance
2e)	Does the national government require an environmental impact assessment (EIA), review or equivalent document (e.g. an Env. Statement)?	YES	Complete Section 3 below.
		NO	Clarify environmental and planning responsibilities with the national government

3. ENVIRONMENTAL LAW			
3a)	Is it likely that a statutory EIA will be required for the project (major infrastructure development including: thermal/hydropower stations, industrial plants, water supply, sewage treatment, solid waste management, airports, roads, ports and harbours) ?	YES	Undertake EIA (or budget for completion of EIA at post-approval stage)
		NO	Complete 3b.)
		NOT KNOWN	
3b)	Is planning permission or environmental permit required from the municipality/ government ?	YES	Complete application (or budget for completion of application at post-approval stage)
		NO	Jump to Section 4.
		NOT KNOWN	

4. PROJECT LOCATION			
4a)	Is the project location known ?		
	If NO, indicate here		And jump to Section 5
	If YES, provide project location description: town, region and continue to 4b)		Project Location
4b)	Will protected or sensitive areas possibly be affected by the project?		Mark those issues applicable to this project
	If NO, indicate here	and jump to Section 5 below.	
	If YES, record relevant issues in this section, then continue at Section 5.		
Issue No.		Yes	No
1	Sensitive human receptors (residents, schools, hospitals)		
2	Groundwater or Surfacewater Vulnerable Areas		
3	Wetland		
4	Cultural heritage		
5	Coral reef		
6	Mangroves		
7	Coastal fringe (harbours, beach, dune)		
8	Estuary		
9	Forest		
10	Nature reserve		
11	World Heritage Site		
		Remarks/Mitigation Measures	



5. CONSTRUCTION/REHABILITATION ACTIVITIES				
5a)	Does the project result in an above ground construction or installation?		Mark those issues applicable to this project	Remarks/Mitigation Measures
	If <b>NO</b> , indicate here	And jump to Section 6 below		
	If <b>YES</b> , record relevant issues in this section, then continue to Section 7			
	Will the work result in the generation of the following:			
<b>Issue No.</b>		<b>Yes</b>	<b>No</b>	
12	Noise (construction/operations)			
13	Odour			
14	Vibration			
15	Air emissions (dust, smoke, etc.)			
16	Traffic (construction and operation)			
17	Fuel and chemical storage (potential for spillage)			
18	Engineering works (infilling, diversion, culverting)			
19	Water (run-off, abstraction and/or discharge, soil erosion)			
20	Marine construction (including dredging and disposal at sea)			
21	Wastes (inert, mining, construction/demolition, clinical, municipal, industrial, hazardous)			

6. HAZARDOUS LOCATIONS				
6a)	Will the project be undertaken in hazardous area (locations in which humans maybe exposed to fire or explosion hazard, chemical risks, physical hazards)		Mark those issues applicable to this project	Remarks/Mitigation Measures
	If <b>NO</b> , indicate here	And jump to Section 7 below		
	If <b>YES</b> , record relevant issues in this section, then continue to Section 7			
	Will the work be undertaken in areas subject to the following:			
<b>Issue No.</b>		<b>Yes</b>	<b>No</b>	
22	Ground contamination (previous industrial sites, landfill, buried livestock)			
23	Areas subject to natural hazards (flooding, earthquakes, landslides)			
24	Past mining and quarrying operations (presence of shafts/spoil heaps)?			
25	Hazardous industrial installations (chemical plants, refineries)			

7. PROCUREMENT ACTIVITIES				
7a)	Does the project result in procurement of goods and services ?		Mark those issues applicable to this project	Remarks/Mitigation Measures
	If <b>NO</b> , indicate here	And jump to Section 8 below		
	If <b>YES</b> , record relevant issues in this section, then continue to Section 6			
<b>Issue No.</b>			<b>Yes</b>	<b>No</b>
26	Products that contain <i>harmful substances</i> or are <i>unsafe</i> (asbestos, PCB's, ozone-depleting substances, oils, solvents, chemicals, pesticides) are avoided			
27	Products selected rated as having <i>high energy efficiency</i> of the type of items needed and available ?			
28	Products contain <i>recycled</i> materials ?			
29	Products (including packaging) can be <i>re-used</i> or <i>re-cycled</i> ?			
30	The products include <i>environmental control technologies</i> (low air emissions/odour/noise, waste minimization),			
31	Products are to be <i>transported</i> in bulk and distributed efficiently to minimize fuel use, road damage, air pollution, noise, desertification, etc. ?			
32	Products will not include the <i>agricultural introduction</i> of invasive plant and animal species or Genetically Modified Organisms (GMOs) ?			
33	Project will not include the exploitation of <i>local natural resources</i> (timber, minerals, water)			

8. TRAINING AND CAPACITY BUILDING (CB) ACTIVITIES				
8a)	Does the project involve training and capacity building in impacted country ?		Mark those issues applicable to this project	Remarks/Mitigation Measures
	If <b>NO</b> , indicate here	And jump to Section 9 below		
	If <b>YES</b> , record relevant issues in this section, then continue to Section 9			
<b>Issue No.</b>			<b>Yes</b>	<b>No</b>
32	The training/CB minimises travel by use of conference calls, video links, etc.			
33	The training/CB minimises the use of paper use (double-sided printing, use of emails for report review)			

**9. PROJECT ENVIRONMENTAL REVIEW RECORD APPROVAL**

Proposal Manager: Name		Cluster Manager: Name	
Proposal Manager: Signature		Cluster Manager: Signature	
Proposal Manager: Date		Cluster Manager: Date	

	If there are any other issues or the above issues require additional description use the space below.
<b>Issue No</b>	<b>NOTES (space for additional notes if thought necessary)</b>

This manual was commissioned by United Nations Environment Programme (UNEP), Post-Conflict and Disaster Management Branch (DMB), Geneva together with the UNEP Division of Technology, Industry and Economics (UNEP DTIE), Paris. UNEP would like to acknowledge and thank the following persons for their contributions to the report:

### PROJECT TEAM:

#### SKAT - Swiss Resource Centre and Consultancies for Development

Claudia Schneider	Author and Concept, Sustainable Building and Settlement Development Specialist
Daniel Schwitter	Co-editor, Senior Architect and Settlement Specialist
Martin Läng	Editing Assistance, Desk Top Publishing Specialist

### UNEP

Niclas Svenningsen	Programme Officer, Division for Technology Industry and Economics, UNEP Paris
Jon Godson	Senior Environmental Expert, Post-Conflict and Disaster Management Branch, UNEP, Geneva
John Carstensen	Senior Programme Officer, Post-Conflict and Disaster Management Branch, UNEP, Geneva

### OTHER CONTRIBUTORS:

#### SKAT - Swiss Resource Centre and Consultancies for Development

Jürg Christen	Senior Social Infrastructure and Environmental Management Specialist
Roger Schmid	Water and Environmental Sanitation Specialist / Transport Specialist
Jonathan Hecke	Environmental Sanitation Specialist

### UNEP

Pasi Rinne	Chief, Disaster Management Branch, UNEP, Geneva
Thad Mermer	Associated Information Officer, Division for Technology Industry and Economics, UNEP
Mark Radka	Chief, Energy Branch, UNEP
Jan Kappens	Junior Professional Officer, Energy Branch, DTIE
Yuwaree In-na	Environmental Affairs Officer, Regional Office for Asia and the Pacific, UNEP
Mahesh Pradhan	Programme Officer, Regional Office for Asia and the Pacific, UNEP
Glenn Dolcemascolo	Disaster Risk Adviser, Post-Conflict and Disaster Management Branch, UNEP, Geneva
Elena Orlyk	Project Assistant, Post-Conflict and Disaster Management Branch, UNEP, Geneva
Farhan Helmy	National Liaison Officer, UNEP, Jakarta, Indonesia
John Poulsen	Environmental Policy Adviser, UNEP, Aceh, Indonesia
Anne Cramwinckel	Project Assistant, Disaster Management Branch, UNEP, Geneva
Peace Nganga	Administrative Assistant, UNEP, Nairobi
Milka Kebede	Project Assistant, Disaster Management Branch, UNEP, Geneva
David Jensen	Policy Coordinator, Post-Conflict and Disaster Management Branch, UNEP, Geneva
Andrew Morton	Project Coordinator, Post-Conflict and Disaster Management Branch, UNEP, Geneva
John Bennett	Editor, Environmental Consultant
Julian Caldecott	Environmental Consultant
Andrew Jones	Environmental Consultant
Rachel Dolores	Design and Layout

**COLLABORATING PARTNERS:**

Jaana Mioch	UN-HABITAT
Monique Iglebaek	UN-HABITAT
Sugumi Tanaka	UN-HABITAT
Dan Lewis	UN-HABITAT
Tom Corsellis	Shelter Centre
Antonella Vitale	Shelter Centre
Graham Saunders	International Federation of Red Cross and Red Crescent Societies
Jean McCluskey	UNICEF
Alois Müller	Seecon International
Andreas Bold	Swiss Red Cross, Banda Aceh
Mylvakanam	Regional Resource Center for Asia and the Pacific
Lyngararasan	
Batara Tri Rachman	Lafarge, Banda Aceh
Tony Barry	Canadian Red Cross
Badrul Irfan	Leuser International Foundation



SKAT (Swiss Resource Centre and Consultancies for Development)

Vadianstrasse 42

CH-9000 St.Gallen

Switzerland

[www.skat.ch](http://www.skat.ch)

United Nations Environment Programme

P.O. Box 30552

Nairobi – 00100

Kenya

[www.unep.org](http://www.unep.org)

UNEP Division of Technology, Industry & Economics

15 Rue de Milan

75441 Paris Cedex 9

France

[www.unep.fr](http://www.unep.fr)

UNEP Post Conflict and Disaster Management Branch

International Environment House

11-13 Ch. Des Anémones

1219 Châtelaine, Geneva

Switzerland

<http://postconflict.unep.ch>



The Tsunami disaster of 26 December 2004 affected a dozen Indian Ocean countries, including Indonesia, Sri Lanka, Thailand, India and Maldives, Malaysia and Myanmar, with a death toll reportedly exceeding 250,000 and millions of more left homeless. Survivors found shelter in temporary barracks and tents. Since then, there has been a pressing need to provide survivors with adequate permanent housing.

In the aftermath of the disaster, numerous agencies have responded by reconstructing houses and infrastructure. Project managers, however, are often overwhelmed not only by the magnitude of required activities but also by the extent of challenges related to reconstruction.

One of the main challenges is to ensure conceptually sound, robust and practical reconstruction solutions that will minimise the environmental impact. This manual addresses that challenge by providing project managers with guidance in various aspects of sustainable reconstruction, including planning, design, materials, implementation, and maintenance.

[www.unep.org](http://www.unep.org)

United Nations Environment Programme  
P.O. Box 30552 Nairobi, Kenya  
Tel: +254 (0)20 762 1234  
Fax: +254 (0)20 762 3927  
Email: [unepub@unep.org](mailto:unepub@unep.org)



ISBN: 978-92-807-2782-1

Job no.: DTI/0903/PA

**Flow Chart: Sustainable Reconstruction**  
 © Skat 2006

