

plastic sheeting

A guide to the specification and use of plastic sheeting in humanitarian relief

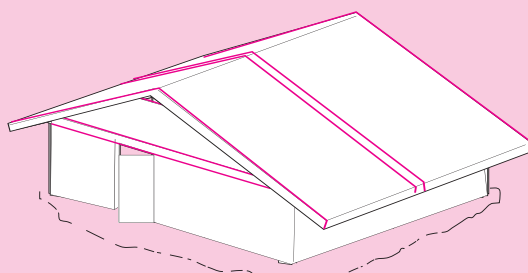
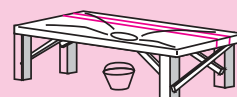
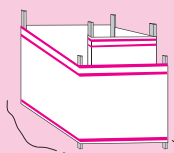
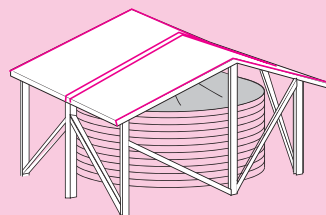
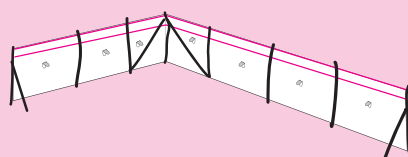
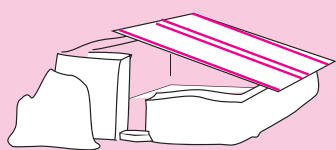

plastic sheeting

This booklet is aimed to help humanitarian aid workers make more informed decisions on the use of plastic sheeting in emergencies. The target audience includes programme managers, field based engineers and technical staff, logisticians and others involved in providing emergency shelter and sanitation services to disaster and conflicted families. Contents include:

- Decision making guidelines for considering when plastic sheeting is an appropriate material;
- How to efficiently specify, transport, warehouse and distribute plastic sheeting;
- International standards and specifications of plastic sheeting;
- Construction details of plastic sheeting as a building material;
- Key climate and performance issues;
- Environmental considerations and safe disposal;
- Guidance on usage of other polyethylene based sheeting products;
- Reference section on where to go for more detailed technical advice.

This booklet recognizes that plastic sheeting is an extremely versatile emergency relief item that can be effective in addressing the immediate needs of displaced or affected families. Although the humanitarian community spends millions of dollars each year on plastic sheeting, some of this is wasted due to poor quality, inadequate specification, and poorly informed usage. It is hoped that this booklet will help promote a better understanding of when plastic sheeting is appropriate, as well as ensuring a wider consistency in the quality of material and technical aid on its use.

Digital versions of this booklet are available to download free of charge (see inside for details).



International Federation
of Red Cross and Red Crescent Societies

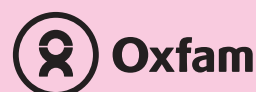

PLASTIC SHEETING

A guide to the specification and use of plastic sheeting in humanitarian relief

i.1 Foreword:

Plastic sheeting is one of the most widely distributed non-food relief items used in humanitarian operations. Each year, hundreds of thousands of square meters of polyethylene sheets are distributed by NGOs, government agencies and private sector. For families displaced by conflicts or whose homes have been damaged by disasters, plastic sheeting can be a useful temporary building material for repairs or emergency shelter structures.

Ensuring that displaced families and communities receive the appropriate types of humanitarian aid in a timely manner is a key objective of all relief agencies and donors. The versatility and low cost of plastic sheeting have made it a default choice for emergency shelter interventions by agencies. Yet in recent disaster responses, variations in the sizes and quality of plastic sheeting distributed to displaced persons suggests a lack of clarity on how plastic sheeting can best support recovery efforts in affected households and their communities.

As part of their organizational mandates to encourage more effective and coordinated humanitarian aid, The International Federation of the Red Cross and Red Crescent Societies (IFRC) and affiliate members of Oxfam International have collaborated on the production and distribution of these technical guidelines on the specification and uses of plastic sheeting in emergencies. Informed by research into good practices in humanitarian responses where the timely delivery of plastic sheeting has been proven effective in meeting emergency shelter and sanitation needs, the contents of these guidelines have been reviewed by peer review panels in Europe, the UK and the US. Over 75 persons representing humanitarian agencies, donors, manufacturers, and independent consultants have contributed to draft versions of these guidelines. IFRC and Oxfam are extremely grateful for the valuable input these individuals have offered.

Given the variety of local building practices and cultures where humanitarian interventions occur, these guidelines are not intended to be a definitive how-to guide for using plastic sheeting as a construction material. The key question that the authors, editors, and reviewers of these guidelines wish to ask is not “how to build a better shelter”, but “how to best support local recovery efforts while moving simultaneously towards more durable and dignified shelter solutions”. It is hoped that these guidelines will help decision makers and programme staff better understand how plastic sheeting can be useful in addressing this goal.

Graham Saunders, IFRC

Rick Bauer, Oxfam GB

July 2007

i.2 Acknowledgments:

These guidelines are the result of an inter organisational collaboration between IFRC, Oxfam and many other agencies. The lead author and illustrator is Joseph Ashmore, with editorial support from Neil Bauman and additional illustrations by Seki Hirano.

The following individuals have provided content, comments and support:

John Adams, John Adlam, Madina Aliberdieva, Richard Allen, Eddie Argenal, Miriam Aschenasy, Sonia Ashmore, Ralph Ashton, Lizzie Babister, Graham Barnes, James Shepherd-Barron, Andy Bastable, Jane Bean, Elizabeth Bellardo, Naomi Bourne, Marc Bretton, Gordon Browne, Matthew Burns, Nan Buzard, Heidi Chase, Mikhail Chitashvili, Hannah Claire, Ed Cooke, Nate Cooper, Tom Corsellis, Sally Crook, Bob Demeranville, Dave Eastman, Matt Ellingson, Patrick Ettampola, Deborah Hayes, Charles Kelly, James Kennedy, Rob Kissick, Liam Florey, Bill Flinn, Jon Fowler, Jacqui Gavin, Sara Gullo, John Howard, Malcolm Johnstone, Bruce LeBel, Andrew Loven, Simon Lucas, Richard Luff, Peter Manfield, Julia Macro, LeGrand Lee Malany, Charlie Mason, Susie Maugham, Robin Mays, Jean McCluskey, Jerome Michon, Leon Miles, Trish Morrow, Isabelle de Muysen-Boucher, Patrick Oger, Morten Peterson, Regan Potangaroa, Linda Poteat, Scott Powell, Kenny Rae, Maxwell Ramnaps, Simon Reeves, Omar Horacio Rincon, Lucy Russell, Farhan Sarwar, Charles Setchell, Meredith Sisa, Elizabeth Stalder, Sara Sywulka, Samuel Treglown, Baard Vandvik, Antonella Vitale, Mia Vukojevic, Wayne While, Tom White, Eric Williams, Nicholas Willson, Vicki Wooding, Jake Zarins, Jürg Zwygart.

The financing of this booklet has been provided by the International Federation of Red Cross and Red Crescent Societies (IFRC) and affiliate agencies of Oxfam International.

These guidelines made use of material developed in "Tents, a guide to the use and logistics of tents in humanitarian relief", (UN/OCHA, 2004) and the scoping study of "Timber, a guide to the procurement and use of timber in humanitarian relief", (UN/OCHA 2007) (www.humanitarian timber.org).

The MSF Logistics Catalogue, the ICRC/IFRC Relief Items Catalogue and the MSF technical archives provided essential technical content.

Inspiration for these guidelines came from Howard and Spice, 1973 Oxfam Technical Guide Plastic Sheeting: Its Use for Emergency Housing and Other Purposes, Oxfam Publishing.

Digital versions of this document are available as a free download at the following websites:

<http://www.oxfam.org.uk>
<http://www.humanitarianreform.org>
<http://ochaonline.org>
<http://www.shelterlibrary.org>
http://www.plastic_sheeting.org

French and Spanish editions will be available in print and digital versions in late 2007.

While Oxfam and IFRC have taken all reasonable steps to ensure the accuracy and completeness of the content of this guidance, other than liability for death or personal injury arising from our negligence or for any fraudulent misrepresentation made by us, we accept no liability for any errors or omissions contained within the guidance and we cannot accept liability for any losses suffered, arising out of or in connection with, your use of this guidance.

This guideline is copyright © 2007, by the International Federation of Red Cross and Red Crescent Societies, and Oxfam International.

i.3 Contents

i Introduction

i.1	Foreword:	1
i.2	Acknowledgments:	2
i.3	Contents	3
i.4	Booklet overview	5
i.4.1	What is plastic sheeting?	6

Section A Planning and Use

A.1	Planning – think before you build	9
A.1.1	Is plastic sheeting an appropriate response?	9
A.1.2	When to use plastic sheeting	10
A.1.3	Which sheeting and fixings to use?	11
A.1.4	Selecting and planning a site	12
A.1.5	How much plastic sheeting do I need?	12
A.2	Alternatives to plastic sheeting	13
A.2.1	Materials	13
A.2.2	Tents and prefabricated structures	14
A.3	Logistics and distribution	15
A.3.1	Transport	15
A.3.2	Warehousing	15
A.3.3	Distribution	16
A.3.4	Monitoring	17
A.4	Using plastic sheeting	18
A.4.1	Shelter	18
A.4.2	Sanitation and water collection	20
A.4.3	Infrastructure and other uses	22
A.5	Fixing plastic sheeting	24
A.5.1	Spread the load	24
A.5.2	Keep sheeting tight - avoid flapping	27
A.5.3	Avoid sharp points	27
A.5.4	Avoid hot spots.	27
A.6	Climate	28
A.6.1	Cold climates	28
A.6.2	Hot climates	29
A.7	Fire safety	30
A.8	Disposal and re-use	31
A.8.1	Repair	31
A.8.2	Reuse / Recycle	31
A.8.3	Incineration (at 1200°C)	32
A.8.4	Burial	32
A.9	Other types of sheeting	33
A.9.1	Shade net	33
A.9.2	Insecticide Treated Plastic Sheeting (ITPS)	33

Section B Specification

B.1 Purchasing plastic sheeting	37
B.1.1 International Procurement	37
B.1.2 National / local purchase	37
B.2 Specifications	38
B.2.1 About plastic sheeting	38
B.2.2 Testing standards	39
B.2.3 Standard specification: Rolls and sheets	39
B.2.4 Translucent sheeting	42
B.2.5 Flooring	43
B.2.6 Insecticide treated plastic sheeting	43
B.2.7 Rope	44
B.3 Testing quality	45

ii Appendix

ii.1 Glossary and acronyms	49
ii.2 Further reading	51
ii.2.1 General reference	51
ii.2.2 Plastic sheeting / Shade net	51
ii.2.3 Sanitation	51
ii.2.4 Shelter guidelines	51
ii.2.5 Infrastructure	51
ii.2.6 Relief Item catalogues / specification	52

i.4 Booklet overview

This booklet explains how and when plastic sheeting should be used in humanitarian responses. It considers the key uses of plastic sheeting in construction, including family shelter, sanitation and infrastructure usage. This booklet does not see plastic sheeting as the ideal material for all circumstances but is intended to support its effectiveness when it is used.

What is this book all about?

This booklet is split into two key sections: **Section A** focuses on when and how to use plastic sheeting, **Section B** on the detailed specification of plastic sheeting. The Appendices contain a glossary of terms (**Appendix ii.1**) used and **further reading (Appendix ii.2)**.

The main themes of this booklet are:

- Plastic sheeting should be procured to minimum standards (Section B.2) to ensure a minimum quality of response and that repeat distributions are not necessary.
- Materials more durable than plastic sheeting may be available locally and should be considered as an alternative.

When distributed:

- Plastic sheeting is not a building solution on its own. It must be combined with materials to form a structure and fixings to securely attach it.

I have my plastic sheeting, but how am I going to attach it?

Plastic sheeting is only a temporary solution

The anticipated lifetime of plastic sheeting is less than 2 years. It is often used to cover emergency shelter and sanitation needs until more durable solutions are found.

i.4.1 What is plastic sheeting?

Plastic sheeting (also known as plastic tarpaulin, tarp or polythene sheet) is a sheet of strong, flexible, water resistant or waterproof material. Although different qualities exist, those suitable for humanitarian relief are made from polyethylene. A standard sheet has a black woven or braided core and is laminated on both sides. All plastic sheeting must reach minimum performance standards (B.2.3).

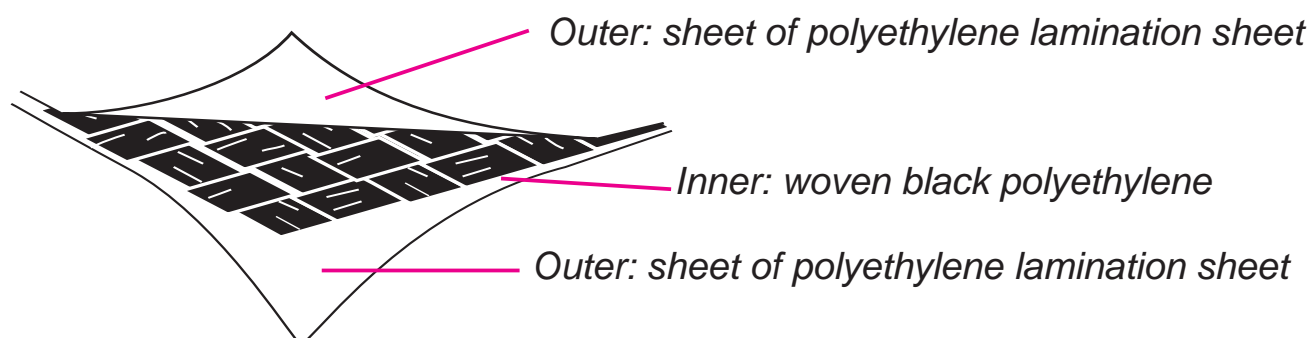

The illustration shows a section of plastic sheet with outer layers peeled away.

Uses of plastic sheeting

Plastic sheeting is primarily used in construction for family shelter, sanitation or infrastructure projects, although it has many other uses.

Some of the many uses of plastic sheeting	
<p>Family shelter (A.4.1)</p> <ul style="list-style-type: none"> - Basic shelter structures - Repair of damaged buildings - Upgrade of tents and shelters - Timber framed shelters 	
<p>Sanitation and water supply (A.4.2)</p> <ul style="list-style-type: none"> - Latrines - Washrooms - Protection of water tanks 	
<p>Infrastructure and other uses (A.4.3)</p> <ul style="list-style-type: none"> - Fencing - Repair of schools and clinics - Temporary structures - Rainwater harvesting - Cholera beds - Market stalls - Food storage and drying 	

Introduction

Section A Planning and Use

This section is primarily aimed at programme and field staff. It focuses on when and how to use plastic sheeting.

A.1	Planning – think before you build	9
A.2	Alternatives to plastic sheeting	13
A.3	Logistics and distribution	15
A.4	Using plastic sheeting	18
A.5	Fixing plastic sheeting	24
A.6	Climate	28
A.7	Fire safety	30
A.8	Disposal and re-use	31
A.9	Other types of sheeting	33

Section B Specification

Appendix

A.1 Planning – think before you build

A.1.1 Is plastic sheeting an appropriate response?

Plastic Sheeting is one of the most versatile materials available for humanitarian relief. The emergency shelter, sanitation and infrastructure needs of hundreds of thousands of people are assisted through the planned distribution of plastic sheeting. However, plastic sheeting should not be used automatically in all situations, simply because it is easily available.

Need

Before new structures using plastic sheeting are built, a need for them should be clearly established through a properly informed assessment. For example, people might find their own shelter with relatives or friends, or make temporary repairs to their damaged homes, so new shelters might not be needed. As part of the assessment, focus group discussions or interviews should be used to identify the needs and capacities of the affected population.



Can we help families to live with other families or to rent? Do we really need to build a new camp?

Have we discussed with the people, including the women, what their needs really are?

The site

Most disaster or conflict affected people prefer to stay in or near their homes when possible. Displaced people (those who are forced to move) often remain at the new site long after supporting organisations have left. Before specifying plastic sheeting as an emergency shelter material, ensure that the site where people will rebuild is safe and that all affected people feel secure and protected (Section A.1.4).

That is my land - you cannot build public latrines there!

Maintenance

Plastic sheeting is not intended for long term use, especially in harsh climates. When considering whether to use plastic sheeting, ensure that end users have the tools and information needed to make simple repairs. For public buildings, ensure that maintenance plans are agreed upon when organisations have left.

Environment

When plastic sheeting is distributed, people often cut trees to provide frames for buildings. To reduce environmental damage consider distributing framing and support.

Plastic sheeting is made from non-renewable resources, and can be damaging to the local environment if not properly disposed of (A.8).

This area is rapidly becoming a desert but I need some poles to hold up my plastic sheet...

A.1.2 When to use plastic sheeting

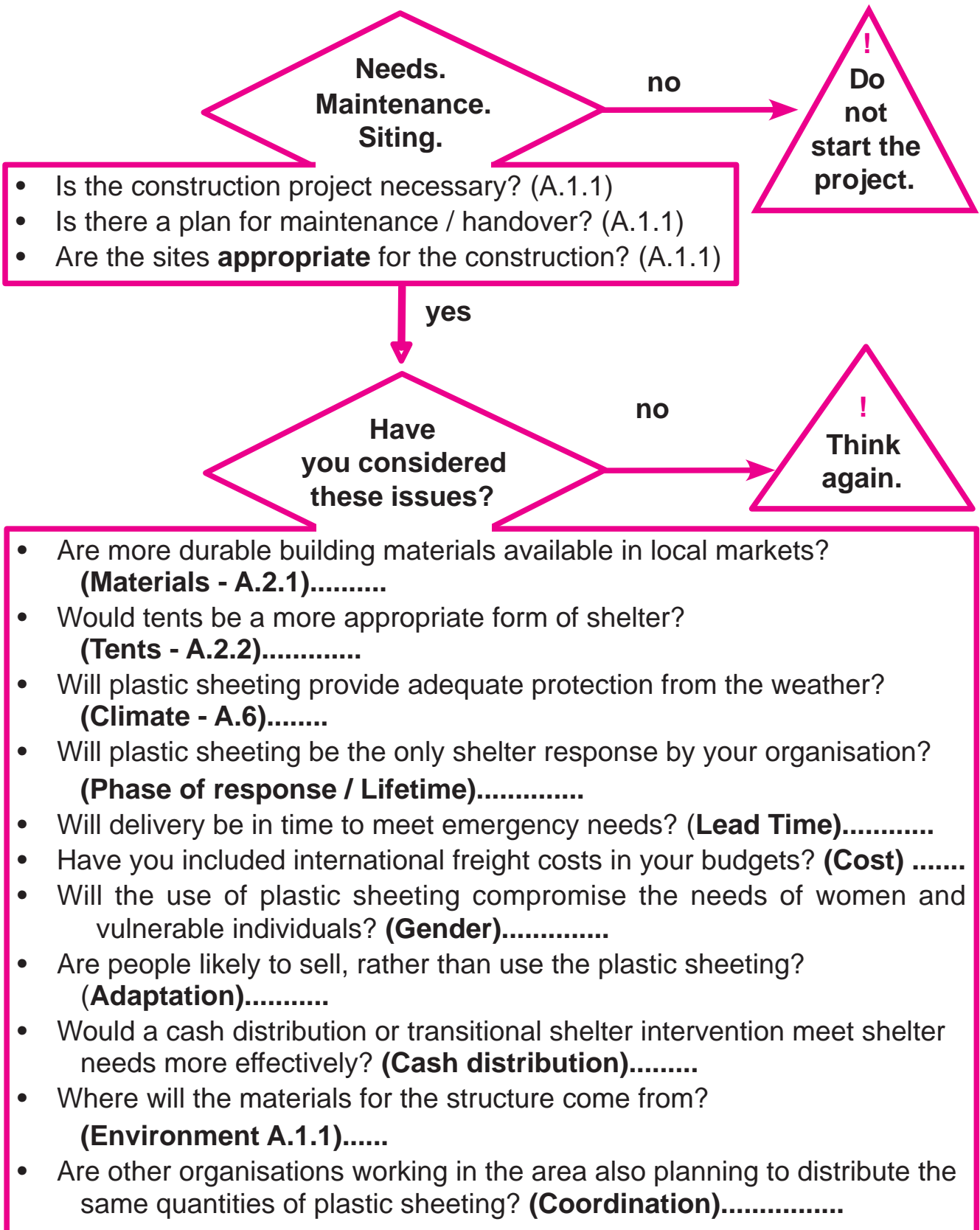

A.1.3 Which sheeting and fixings to use?

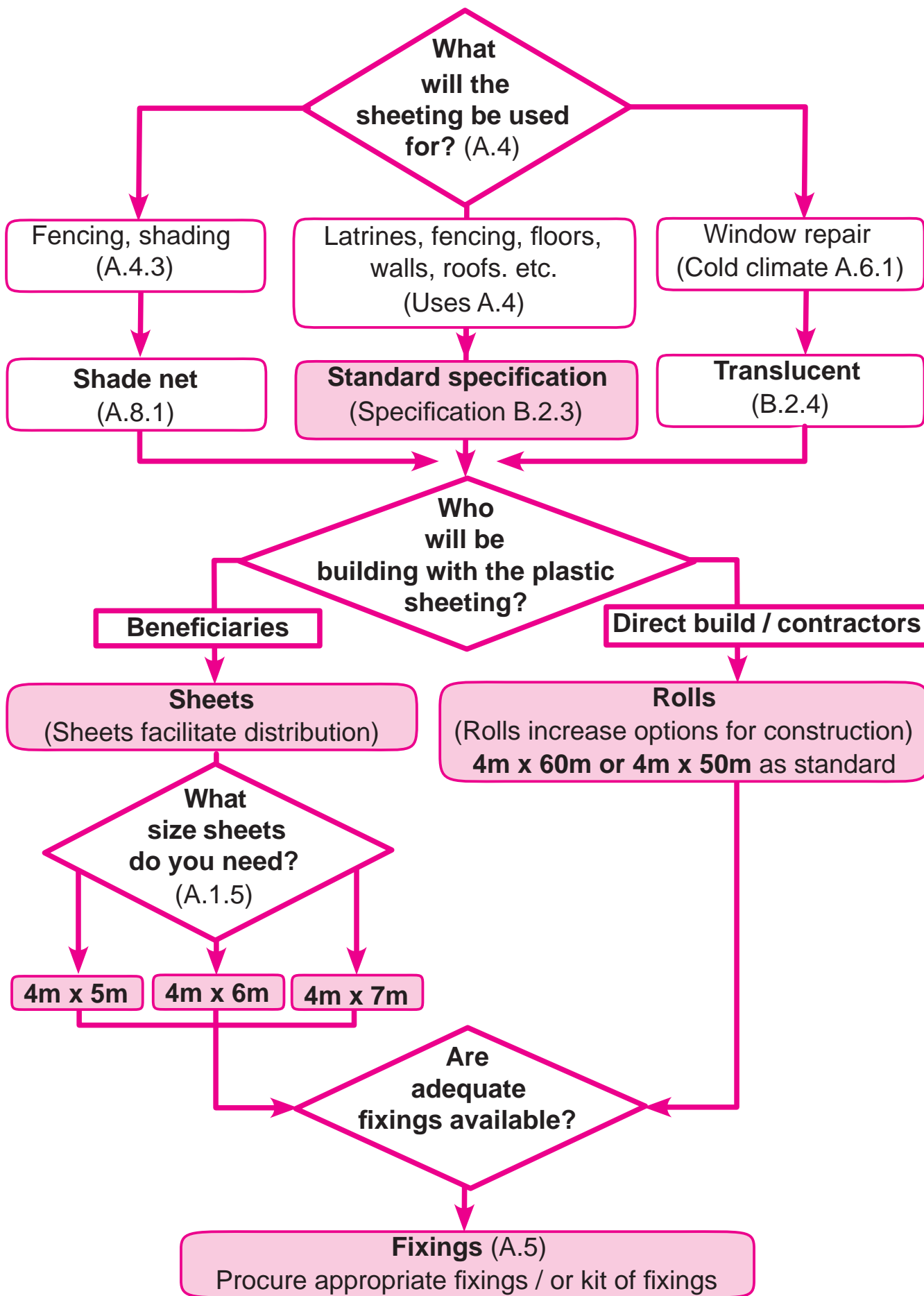

A.1.4 Selecting and planning a site

Avoid camps

Often new settlements, or camps, are built far away from work opportunities and require long term external support. Camps should be avoided.

Is this really the best place to build?

Develop a site plan

Before building with plastic sheeting, have a clear plan for the site. Care should be taken to ensure privacy, access to water and safety at sanitation facilities. Special care should be taken with placing vulnerable people.

Is the site big enough?

Often plastic sheeting is used in crowded environments. Sphere indicators and guidelines from UNHCR (Appendix ii.2) suggest aiming to provide at least 45 m² per person over the whole site including facilities such as water points, roads and basic gardens.

Hazards

Avoid using land prone to hazards such as flooding. If it is necessary to build on land prone to landslides, be aware plastic sheeting will not be able to stop falling rocks.

For more on site planning and selection see further reading in Appendix ii.2. Ideally hire experienced specialists to help.

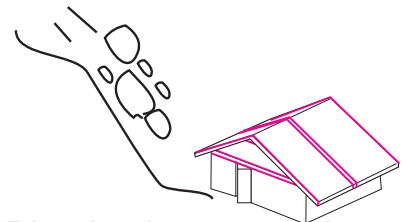

Plastic sheet provides no protection from hazards such as falling rocks...

A.1.5 How much plastic sheeting do I need?

Common guidance (ii.2.1) suggests aiming to provide a minimum of 3.5m² covered space per person. By these indicators, one 5m x 4m sheet will provide a sloping roof with no floor or walls for three people only. A 6m x 4m will provide roof with no floor or walls for only four people.

Effective covered areas are smaller than plastic sheets themselves.

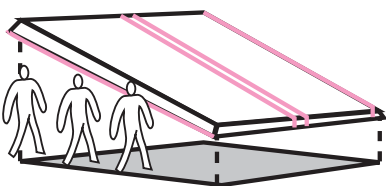

5m x 4m sheet:
13.5m² effective covered area (without walls).

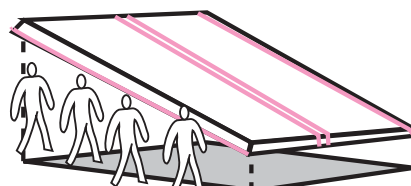

6m x 4m sheet:
16.5m² effective covered area (without walls).

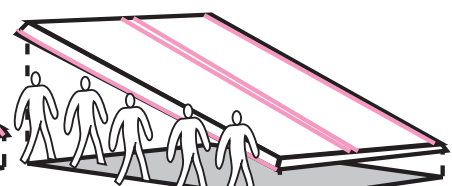

7m x 4m sheet:
19.5m² effective covered area (without walls).

(examples based on 30° pitched roof allowing 25cm each side for fixings.)

A.2 Alternatives to plastic sheeting

A.2.1 Materials

In any construction, the design and materials used must be appropriate to the local skills, climate and culture.

Plastic sheeting may not be the only material available for the given job. There may often be more appropriate materials available locally. Some examples are illustrated in the diagram below:

I could find these natural materials locally:

- Palm, banana or other leaves
- Thatch or other grasses
- Adobe (particularly for walls)..

I might be able to get these materials made locally

- Cement or fired earth tiles,
- Woven bamboo sheets

I could use these man-made materials but I might have to bring them from the city:

- Waxed canvas tarpaulin
- Tarred sheet
- Corrugated iron (CGI)
- Plywood or fibreboard
- Cement
- Tents
- Foam or plastic mats (flooring)

I could even get beds made to keep people off the ground.

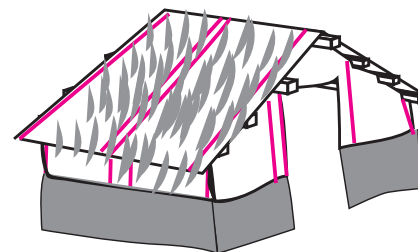

This building uses many different materials including grass to protect the plastic sheet, a low stone wall, plastic sheeting and a timber frame.

Environment, lead time and market inflation

The environmental impact of the bulk use of local materials should carefully be considered. Lead times can be long as production might be on a small scale. Additionally, large scale purchases of materials can distort local and even national markets.

In some cases, a combination of different construction materials could prove to be the most appropriate.

Resale value and cash distributions

Many materials distributed in emergencies can be re-traded and sold in local markets. Plastic sheeting is more likely to be sold if there is a lack of coordination among distribution agencies, or if the distribution continues after the initial emergency phase. If agency-distributed plastic sheeting is appearing in large quantities in local markets, assess whether the programme objectives might be more effectively realized through other means. This might include distribution of local building materials, cash, or engaging in more direct livelihood support activities.

A.2.2 Tents and prefabricated structures

Tents can rapidly create cover. They also contain the supporting structure and the fixings. Tents should be considered when:

- Supporting materials (e.g. Poles for structures) are scarce (especially in fragile environments).
- Existing structures cannot be used, even with rapid repairs.
- Skills or the capacity to construct are limited.
- Large structures (clinics or warehouses) are needed.
- Basic structures made from plastic sheeting cannot provide sufficient shelter from the climate.

However tents can have longer lead times than plastic sheeting, are significantly more bulky, complex and more costly to procure. As with plastic sheeting they also have a limited lifetime.

I like this tent because it is easy and quick to use, and it contains both the cover and the structure.

But it is difficult and expensive to procure, rots in storage, is heavy, and does not help toward the long term housing needs of the people.

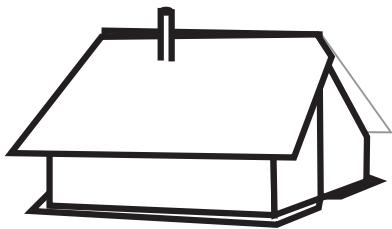

Prefabs

Prefabricated, flat-packed, and container structures generally have a high unit cost, a long production and transportation time, a high transportation cost, and can be inflexible. It is not advisable to use them as family shelter in any of the guidelines listed in annex ii.2, however, they may be used to cover various infrastructure needs, such as emergency operating theatres or accommodation for organisations.

I do not like this metal box or this dome because they are nothing like my old house.

These are expensive. I could have built something better and cheaper!

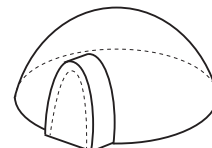
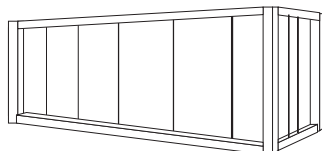

A.3 Logistics and distribution

Most organisations have their own logistics and procurement procedures which should take precedence over the information provided in this booklet. Guidance on specification and information for procurement can be found in Section B.

A.3.1 Transport

Air freight

Although plastic sheeting is lighter than most building materials, air freighting it can cost more than the sheeting costs to purchase.

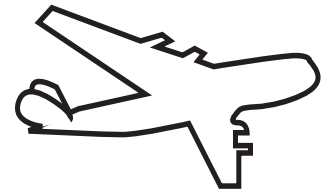

Shipping

Although slower than air freighting, shipping is significantly cheaper. Approximate shipping times are given below:

China to Indonesia 18 days

China to East Africa 25 days



Weight / volume information

1MT of plastic sheeting occupies a volume of about 2.5m³ (number of sheets / rolls / per container are in Section B.2.3)

Transport of fixings

Nails and loose fixings must be carefully packaged or alternatives sought if they are to be transported by helicopter.

A.3.2 Warehousing

Plastic sheeting should be kept out of the sun, away from rodents and in a dry location.

Plastic sheeting comes in rolls or sheets, and should be warehoused in piles of known size and quantity as per standard warehousing procedures. Plastic sheeting is usually delivered in rolls or in bundles of either five or ten sheets.

Stored away from sunlight (the key cause of plastic sheeting decay)



Easily countable piles

Rolls in metal cages to prevent collapse of piles

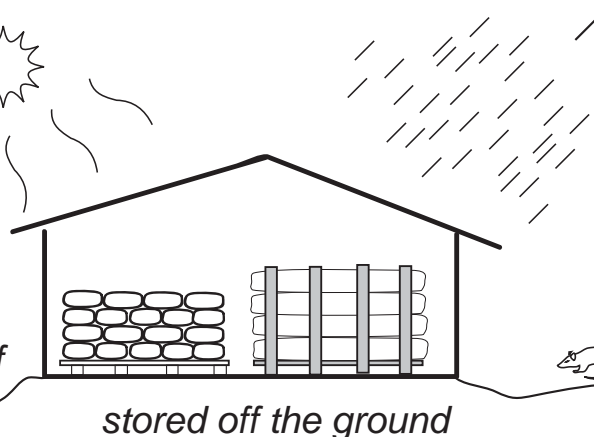

Dry Storage (to prevent mould growth)

Free from rodents that can chew through plastic sheeting

stored off the ground

As plastic sheeting is slippery (particularly when packed in plastic), stacks should not be built too high in order to prevent stacks from falling over.

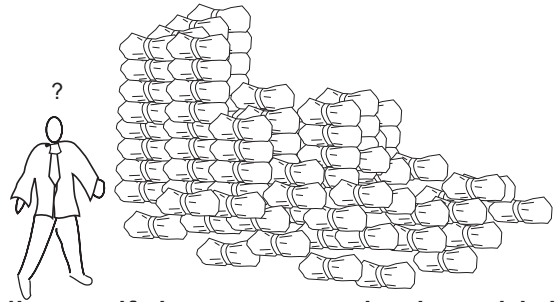
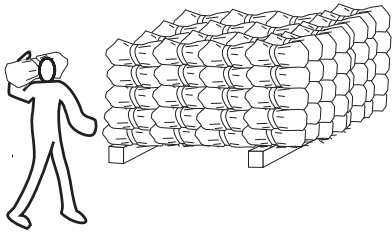

Bales will fall over if they are stacked too high.



Handling of Insecticide treated plastic sheeting

If used, particular care should be taken when handling insecticide treated plastic sheeting (Section A.9.2), as workers can get irritated or inflamed skin.

A.3.3 Distribution

Sheets or rolls

In many cases plastic sheeting will be used directly by organisations or their contractors. In other cases it will be distributed directly to families or community based organisations, with the intention that it will be used for shelter, flooring for latrines, or washroom construction.

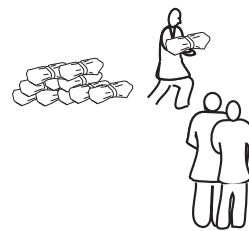
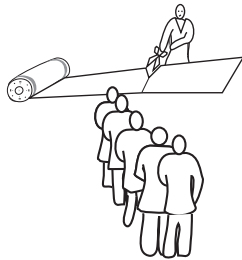

With direct distribution, individual sheets (right) can be easier to distribute than cutting sheets from a roll (left). Cutting sheets to size requires staffing, time, can be difficult to do equitably, and can lead to off cuts remaining at the end of rolls.

- Where distributed directly to beneficiaries, sheets can be easier to handle as they do not require cutting. Where only rolls are available, a clean location for cutting the sheet should be established. Most rolls have marks every metre to facilitate cutting.
- Whether 4m x 5m sheets or 4m x 6m sheets are selected, one sheet will only provide a basic roof, and will not be sufficient for additional walls, floor or partitioning of spaces.

Distribution lists

The key to any distribution is the establishment of clear beneficiary selection criteria. Special care is needed to ensure that vulnerable and hard to reach people are identified. Beneficiary lists are normally compiled by either:

- Asking community leaders or local authorities to provide a list (this may need to be verified)
- By direct registration of beneficiaries.

To ensure orderly and transparent distributions, tokens may be considered. A suitable distribution site must be chosen carefully. Intended beneficiaries must be informed of the distribution time, place and procedures.

Distribution with other NFIs

If plastic sheeting is being distributed with other Non-Food Items (NFIs), then support for transport from the distribution site may be required, especially for vulnerable individuals.



Support people in using plastic sheet

Some people may require technical support to use plastic sheeting properly, especially when distributed for shelter or sanitation use. Additional physical support may be required for vulnerable individuals. Providing support additionally increases the effectiveness and lifetime of plastic sheet.

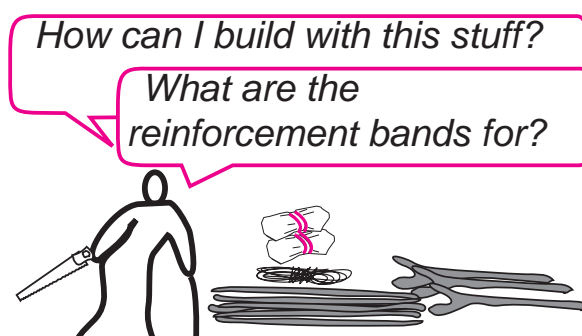

A.3.4 Monitoring

Monitoring the distribution of plastic sheeting is important to ensure that the needs of people have been met. Questions to ask when monitoring plastic sheeting distributions include:

- Are the right people being targeted?
- Has enough plastic sheeting been distributed?
- Is the plastic sheeting of good enough quality?
- Is the short term measure of plastic sheeting still the most appropriate covering material?
- Are trees being cut down to provide poles for structures?
- Is the plastic sheeting being re-sold in local markets?

A.4 Using plastic sheeting

A.4.1 Shelter

Shelter is a **habitable, covered** living space.

Shelter is more than just a roof.

For a space to be habitable, it must offer protection from the elements and have access to water and sanitation.

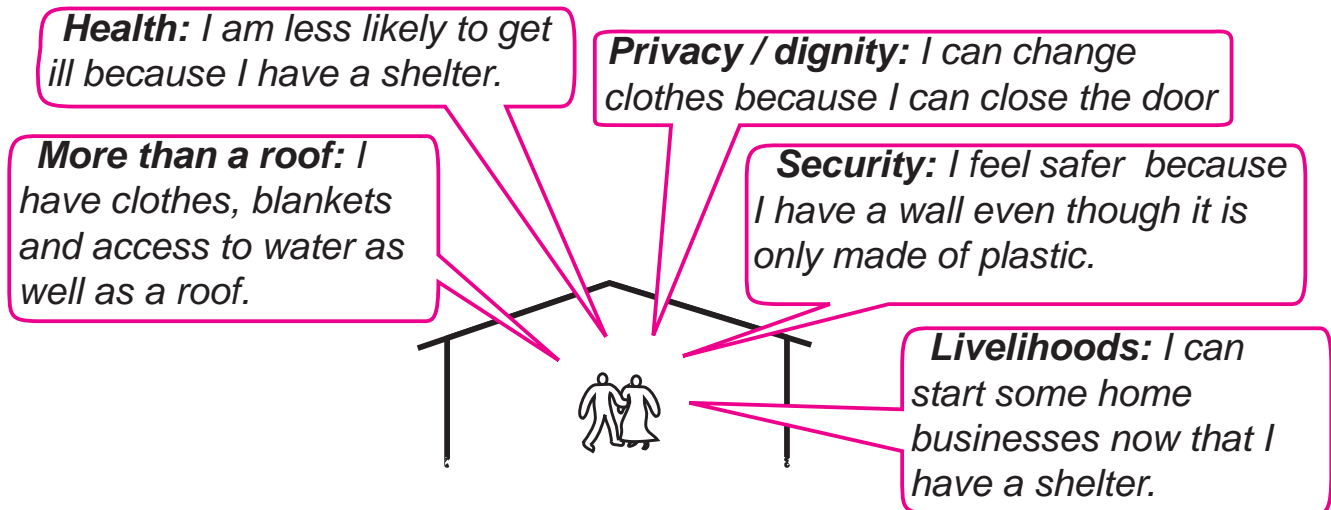

Plastic sheeting in shelter

Plastic sheeting is commonly used in emergency and transitional shelter programmes to provide waterproof cover. It is commonly distributed along with other materials to make rapid repairs or to provide cover to simple structures.

Self help shelter repair kits

Kits of construction materials are commonly distributed to help families repair houses or build shelters with the materials that they have access to. At its most basic, a kit (for the structural component of shelter only) should include **plastic sheeting and other fixings such as rope**. Shelter kit distributions should be accompanied by programmes providing support and training.

The tools distributed in kits should be those that are used locally, and should be of good quality. Fixings should be appropriate to the available construction materials in mind. (As an example 15cm (6") nails might split locally available timber.)

Plastic sheet, plus poles and fixings.

Various uses of plastic sheeting in basic shelters are illustrated overleaf. Although these structures are not ideal, they are commonly required to meet emergency needs following conflict or disasters.

Plastic sheeting can be used in cold climates to create a thermal buffer zone, windows and for emergency upgrading of tents (Section A.6.1).

(Further reading on shelter and settlement can be found in appendix ii.2.4)

Look around and consult with people to find what is being done locally for shelter and how people can best be supported.

Example: A family shelter repair kit following an earthquake
(note: Most items can be purchased nationally. The kit will have to be adapted according to circumstances.)

Roof, and / or walls and floor

- Plastic sheet (A.1.5 for quantities)

Tools - possibly distributed per community instead of per family.

- Hammer
- Saw

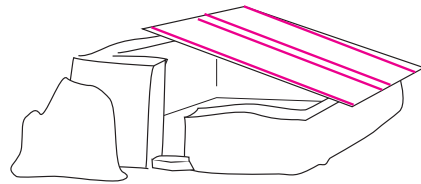

Fixings (A.5)

- Nails (5kg), 5cm -12.5cm, (2" -5")
- Washers (½kg)
- Rope (20m)
- Metal strap, 1mm thick (20 pcs.)
(to nail over / strengthen timber joints)
- Binding wire (5kg)

Example: Waterproof covering for a bush pole and grass matting shelter.
(Design details depend on local construction and materials availability.)

Basic structure - quantities dependent on local design:

- Bush poles - type as used locally
- Strong binding wire
- Woven grass mats
- Oil / diesel - termite treatment

Roof, and / or floor

- Plastic sheet (A.1.5 for quantities)

Fixings (A.5)

- Rope (20m) (for fixing sheeting)

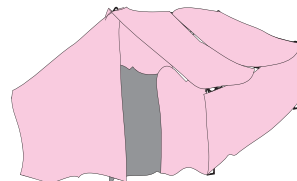
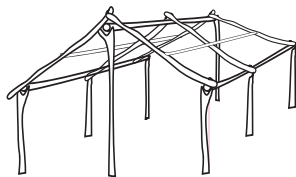

Drainage
ditches

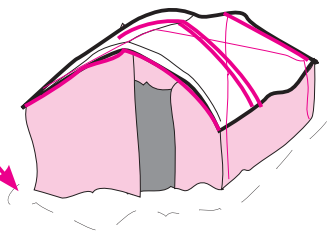

Example: A very basic plastic sheeting shelter (with no ends) for hot climates.

This type of emergency structure is a last resort when no other options are possible. It should be upgraded as soon as possible.

Basic structure and fixings

- Timber for ridge pole (4m long)
- Timber batten for ridge (A.5.1)
- Rope (20m)
- Nails, 5cm, (2"), (½kg)
- Nails, 12.5cm, (5"), (½kg)
- Ground pegs (metal or timber)

Roof, and / or walls and floor

- Plastic sheeting - (A.1.5 for quantities)

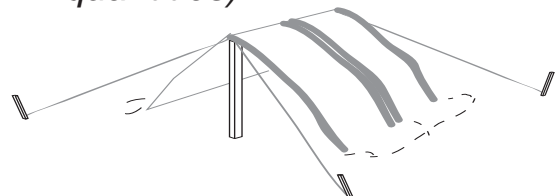

A.4.2 Sanitation and water collection

The **primary objective** of sanitation programmes in disasters is to provide dignity for people and to reduce the risks associated with faecal-oral diseases.

Sanitation programmes commonly include **public health promotion, excreta disposal, vector control, solid waste disposal** and **drainage**.

Sanitation is more than a latrine

Construction on its own will not solve all sanitation issues. Ensure that disaster-affected people have the necessary information, knowledge and understanding to prevent disease from poor sanitation.

We did not use latrines or wash our hands with soap in our old village - why should we start now?



Latrines

Plastic sheeting is commonly used in latrine construction. In extreme emergency situations, this might be a defecation field. In more established settings, it should be possible to build individual family latrines. Remember that the needs of women, children, disabled, and sick people are different than those of men. Special latrine designs may be required.

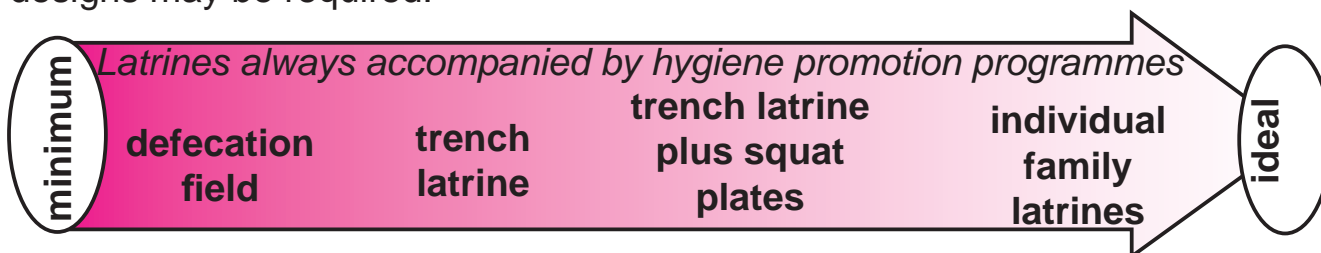

Defecation field

A defecation field is a fenced off area (fencing, section A.4.3) for defecation which is managed in a controlled way. A defecation field requires large amount of land; 10,000 people will require nearly 2 hectares per week. Defecation fields should be avoided wherever possible.

Trench latrine

A trench latrine is made by surrounding an area in plastic sheeting or fabric and digging a few shallow trenches. Trench latrines can be upgraded by putting squat plates over the trenches. Cubicles can then be placed on top.

Latrines and washrooms

Plastic sheeting is commonly used to cover the superstructures of latrines or washrooms. Where blocks of latrines are built together, less material is used but the risk of them falling into disrepair increases due to lack of ownership.

Location of latrines

Proper attention to locating latrines can make it easier for people to use them. Consult with beneficiaries to help to understand where it is best to build. In particular, women and girls are often reluctant to use latrines if they do not feel safe. This is especially true where latrines are located at the edge of settlements or in dark places. In all cases, the siting of latrines must be carefully planned before construction begins.

Example A basic superstructure for latrine / washroom

Structure

- Solid timber poles (6x3m)

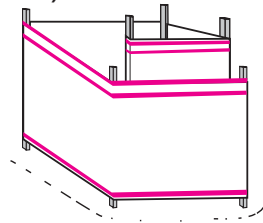

Cover

- Plastic sheet, 6x3m (cut in half)

Fixings

- Domed head nails (1kg)
or nails and battening

Example A superstructure for latrine / washroom using plastic sheeting

Structure

- Timber (0.1M³)
- Nails (3Kg)

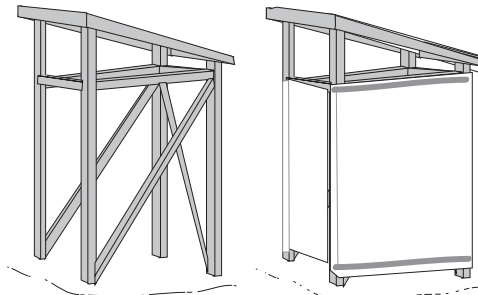

Cover

- Plastic sheet (6.5m²)
- Domed head nails (1kg)
or nails and battening

Building blocks of latrines can save materials but it can be harder to encourage ownership and keep them clean.

Aim for a minimum of one latrine per twenty people

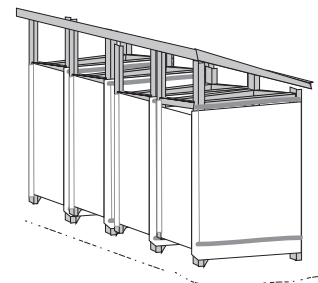

Example: Use of plastic sheeting as temporary but washable latrine slab.



Consult Sphere 2004 (ii.2.1) and Engineering in Emergencies, 2003 (ii.2.3) for further information on sanitation standards and construction.

A.4.3 Infrastructure and other uses

What is infrastructure?

Infrastructure includes the basic facilities, services and installations needed for the functioning of a community or society.

Use of plastic sheeting in infrastructure

Plastic sheeting is commonly used in the repair or construction of temporary buildings for use as clinics, schools, community centres, distribution or registration centres, way stations, offices or warehousing. It is also commonly used for covering of materials and fencing.

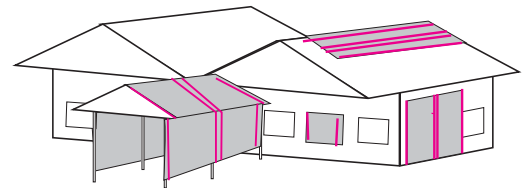

Use of plastic sheeting to make temporary repairs and upgrades to a hospital

Rolls not sheets

When plastic sheeting is to be used for infrastructure purposes by organisations or contractors, it is easier to use by the roll than by using individual sheets.

Shade net

Shade net should be encouraged as a cheaper (but durable) alternative to plastic sheeting for fencing and for the provision of shade in hot climates. (A.8.1, and further reading ii.2.2)

Basic shed

Simple structures are commonly needed for use as clinics, supplementary feeding centres, way stations, registration centres, offices, clinics etc. If materials are available and the land is prepared, simple timber framed structures with 36m² or more covered area can be built in one or two days by a team of 2 carpenters and 4 labourers.

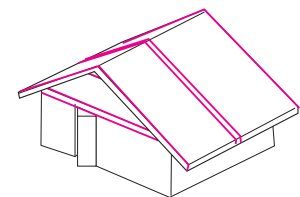

A basic shed

For more detail on sheds, read "Temporary and Semi-permanent Structures for Health Structures in Refugee camps" (Appendix ii.2.5)

Fencing

Often plastic sheeting is used for fencing although it may not always be the most cost effective or appropriate material available. Some examples of alternatives to plastic sheeting are shade net, barrier netting (usually orange plastic netting), wire, barbed wire, wire mesh (chicken wire), straw mats, thatch mats, bamboo, reed mats or rice sacks sewn together.

Using plastic sheeting in fencing

When plastic sheeting is used for fencing, holes should normally be cut in it. The holes will prevent the sheeting from acting like a large sail and will reduce risk of theft.

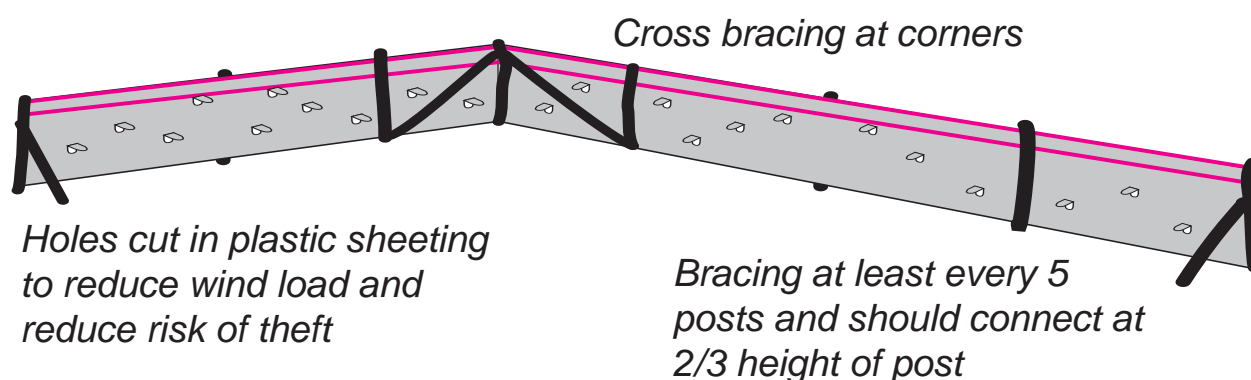

Fencing posts

When using plastic sheeting in fencing, it is normally supported with solid timber posts. These posts should be diagonally braced between posts at the corners. At least every fifth post should have additional bracing.

Drainage ditches

Support people to dig drainage ditches around structures to prevent them from flooding with the rain. Connect the drainage ditches around each building to a site drain.

In some locations, ditches around each structure need to be as much as 50 cm deep.

The plastic has kept our heads dry but our building has flooded.



A.5 Fixing plastic sheeting

Once good quality plastic sheeting (B.2.3) has been procured, the main principles to observe when fixing plastic sheeting are:

- Spread the load (A.5.1).w
- Prevent the sheeting from flapping (A.5.2).
- Avoid contact with points of friction (A.5.3).
- Avoid hot spots (A.5.4).

A.5.1 Spread the load

Fixings of plastic sheeting must be spread over a large area to prevent them from pulling through.

The diagram below shows good and bad practice in fixing plastic sheeting to timber, illustrating how to spread the load across the fixing points.

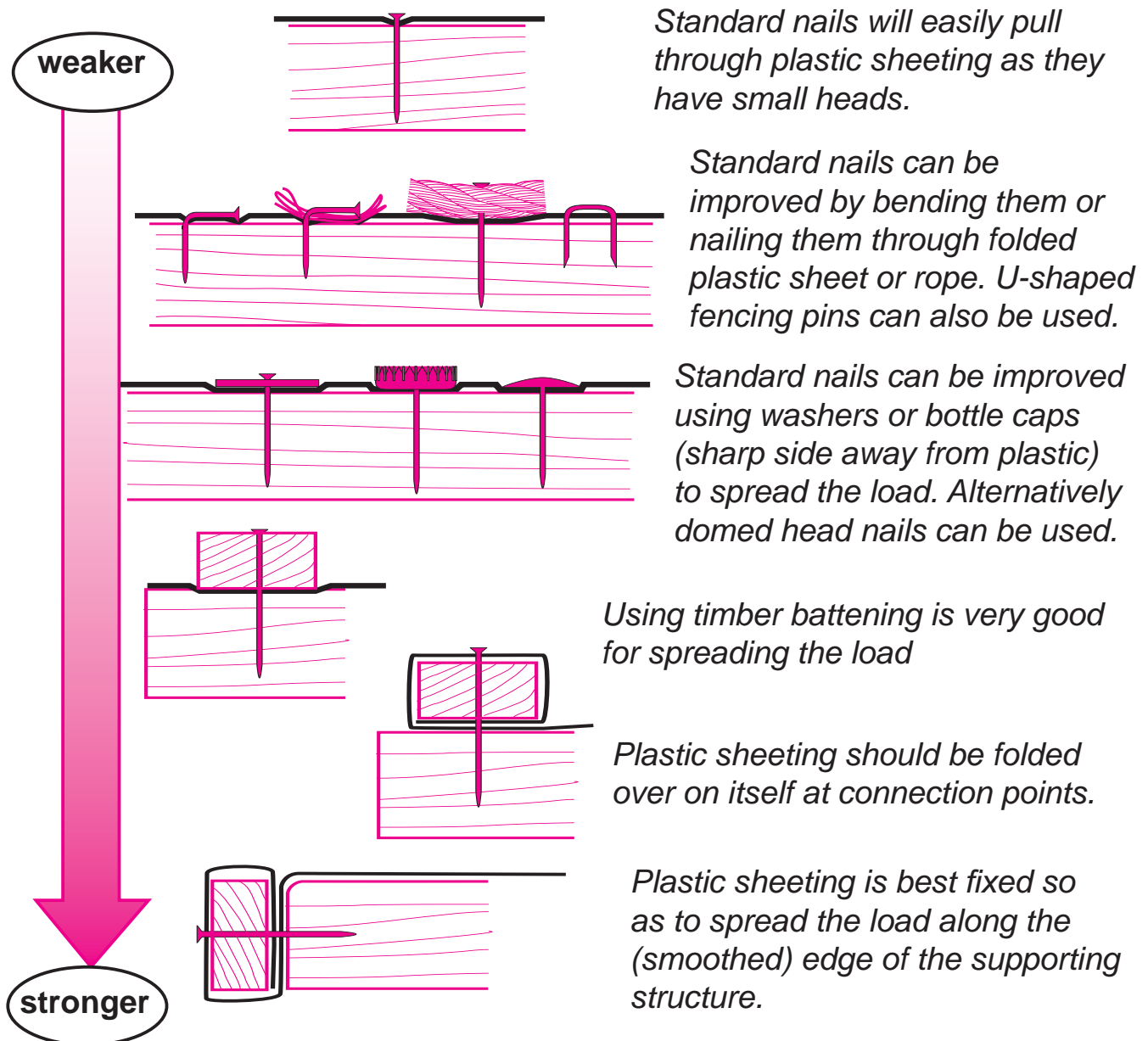

Reinforcement bands

Reinforcement bands (See B.2.1) in plastic sheeting are most commonly grey in colour. If plastic sheeting with reinforcement bands is available, fixings should pass through the bands to add strength to the fixings.

With only a few fixing points, this sheeting is likely to pull free.

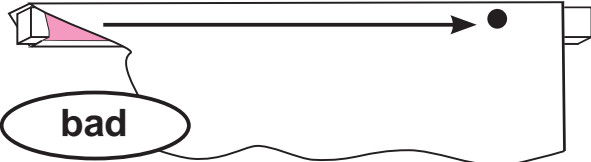

With many fixing points, this sheeting is likely to last longer.

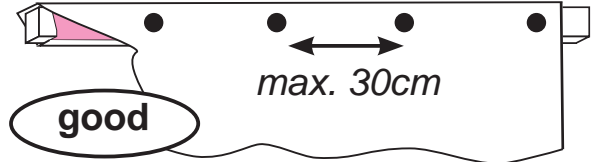

Fixing points should be close together. A maximum of 30 cm apart is suggested

Fixing to the ground

When plastic sheeting is connected directly to the ground, 50cm of additional plastic is required on each side for burying in trenches. If timber is available, then the plastic sheeting can be nailed to timber runners that are pegged to the ground (or connected to the foundations).

Whilst sandy soils will not grip the plastic sheeting as well as other soil types, it may be very difficult to dig trenches in some rocky soils. Choosing a method for fixing the sheeting to the ground therefore depends upon the soil conditions as well as the availability of materials.

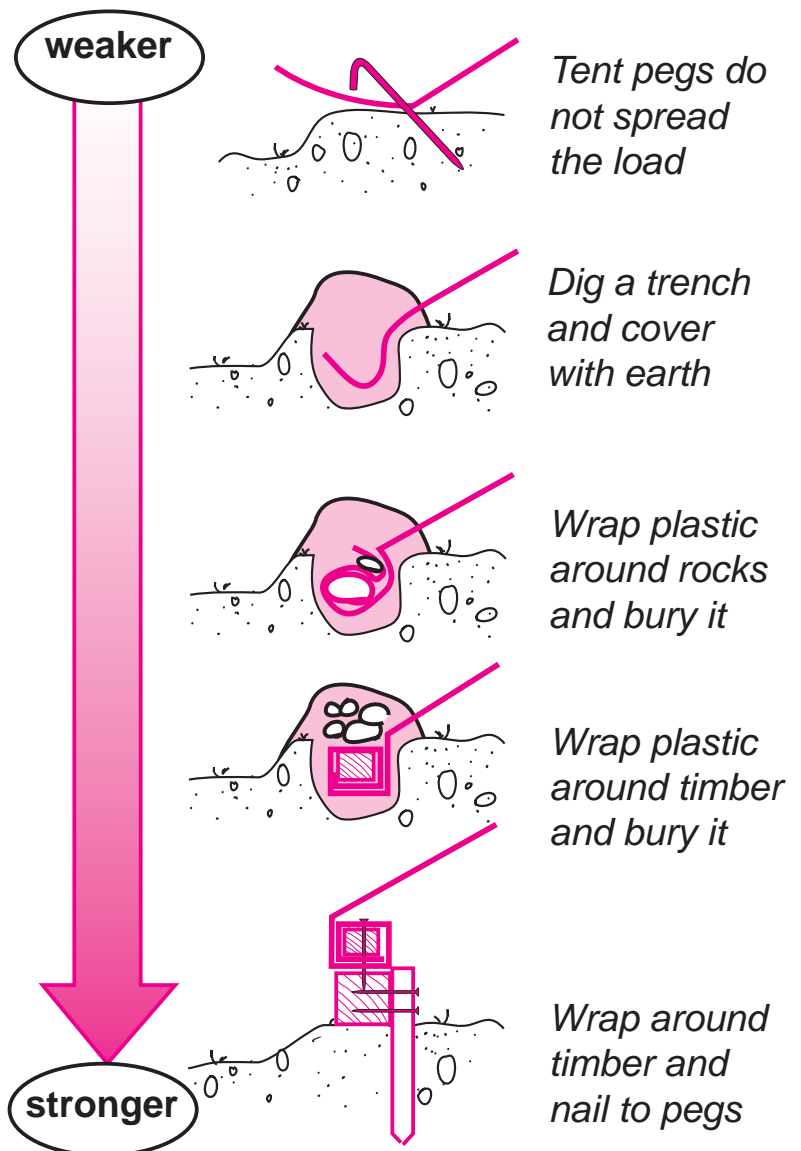

Fixing plastic sheeting to rope: Rock and stone

A strong way of fixing rope to plastic sheeting is to fold a smooth stone (minimum 3cm diameter) inside the plastic sheeting and tie rope or strong cord behind it. This can cause sheets to crease and make them prone to flap in the wind (A.5.2).

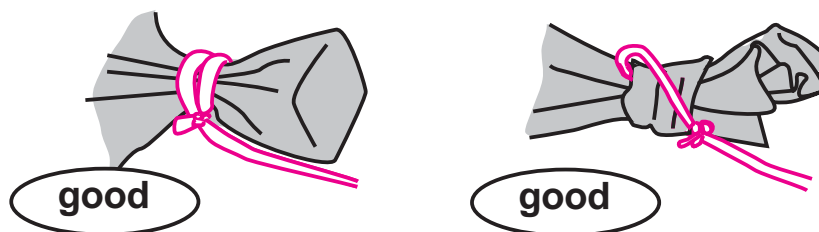

Use a smooth stone or tie a corner to attach the plastic sheeting to a rope.

Fixing plastic sheeting to rope: Reinforcement bands

Plastic sheeting either comes with reinforcement bands or with eyelets fitted. The reinforcement bands are usually grey or blue. Sheeting can be fixed by cutting a small hole in the reinforcement band and tying thick cord through it. Where eyelets are used, they must be of good quality and well fitted (Specification, section B.2.3).

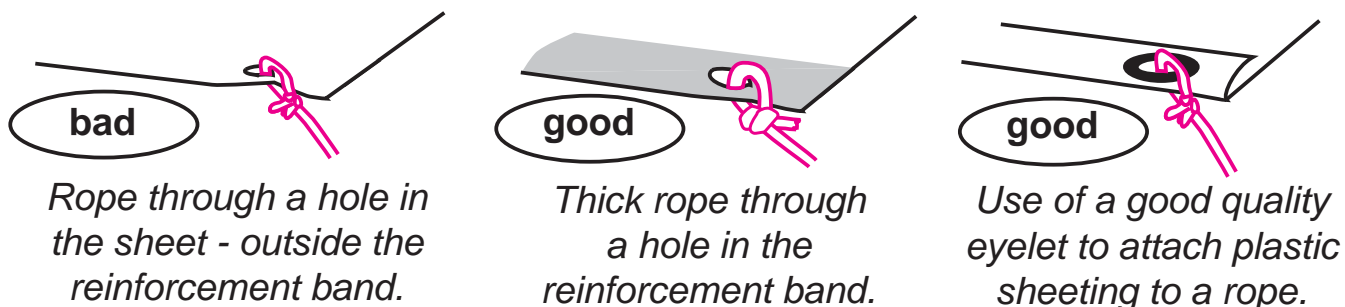

Rope through a hole in the sheet - outside the reinforcement band.

Thick rope through a hole in the reinforcement band.

Use of a good quality eyelet to attach plastic sheeting to a rope.

Sewing sheets together

Sheets are commonly sewn together with thread when people need to join old sheets or need larger sheets. This can be strong if suitable thread is used and they are stitched tightly or sewn with a machine. Because sewing makes holes in the sheet, it can cause leaks. It is best if the sheeting is folded over with an overlap before it is sewn.

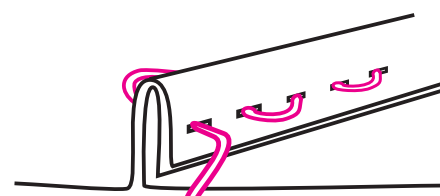

Stitching plastic sheet: overlap sheeting, use strong thread and tight stitching.

Specialised fixings

A variety of specialised fasteners and clips are available for use with plastic sheeting. Made of durable materials, these can offer a strong and quick method for fixing plastic sheeting. However, the high cost of these fixing materials in relation to more commonly available methods suggests that they may be better used in constructing larger buildings for infrastructure rather than single family shelters or latrines.

Elastic cord

Elastic cord can be used to reduce the damage to the sheeting caused by flapping. Elastic cord can be more difficult to find in local markets than rope (B.2.8).

A.5.2 Keep sheeting tight - avoid flapping

When plastic sheeting is not tight, it flaps with the wind and can collect water puddles. This is both noisy and damages the plastic sheeting. To avoid flapping, always encourage people to **pull plastic sheeting tight** when building with it.

Ponding and puddles

With poorly designed roofs, puddles of water can collect on the plastic. These puddles can break the roof, cause the plastic sheeting to stretch, increase the likelihood that roofs will leak, and can become breeding ponds for mosquitos.

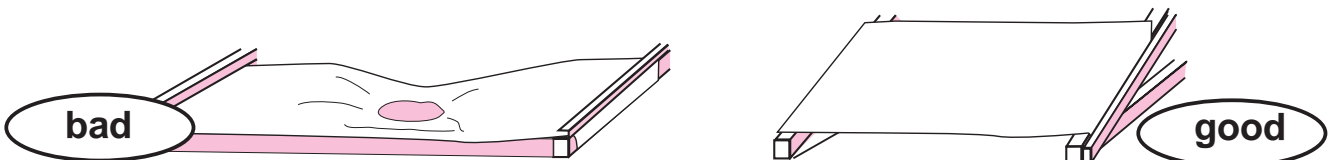

To avoid water puddles forming, ensure that plastic roofs are sloped, that the plastic is fixed taught and there are sufficient well-placed supports.

Expansion with heat

Plastic sheeting can expand by as much as 1% for every 40°C temperature change. Allowance should be made to allow for expansion during the day (to prevent the plastic being slack) and for contraction at night (to prevent the structure from breaking).

A.5.3 Avoid sharp points

Plastic sheeting is easily punctured by sharp points or worn away by rough surfaces (especially if it is not fixed tightly - section 5.2). When building a frame for plastic sheeting ensure that all nails are flush with the timber. Ensure that edges and rough surfaces that will be in contact with the plastic have been smoothed. External objects such as tree branches can puncture plastic sheeting.

I put some sticks inside my shelter to help keep up the roof. Unfortunately they made small holes, and now my roof leaks.



A.5.4 Avoid hot spots.

Plastic sheeting can weaken and break where it is stressed over any structure that will hold and release heat, especially metal or black surfaces. Prevent sheeting from overheating at contact points by:

- Designing structures to reduce the number of contact points.
- Covering the plastic sheeting with opaque adhesive tape on the outside of the cover.
- Painting the plastic sheeting with aluminium or bitumastic paint at the contact points.
- Covering the structure with light coloured insulating material.

A.6 Climate

A.6.1 Cold climates

Plastic sheeting is frequently used as an emergency measure to improve thermal comfort by creating warm rooms, or to help repair damaged buildings and tents.

Cold climate shelter priorities

Priority 1. Clothing and bedding

Warm clothes, hats and blankets can help to keep the immediate space around people warm.



Priority 2. Waterproofing

Plastic sheeting is commonly used to waterproof roof, walls and floors to help to keep people dry.



Priority 3. Bedding

Plastic sheeting under mattresses can help to prevent dampness from rising. It will provide limited thermal insulation from the ground on its own.



Priority 4. Wind proofing / thermal buffer

To ensure a warm living environment, wind proofing is essential. Plastic sheets can block draughts and can be used to help to create a thermal buffer zone.



Priority 5. Heating

Heating of internal spaces must be conducted with care to prevent fire.



Priority 6. Insulation of floor

Although plastic sheeting itself is a poor insulator, it can be used with gravel, straw or other insulators to trap air and reduce damp. (B.2.5 for specification).



Priority 7. Insulation of walls

Plastic sheeting can be used to sandwich insulation material such as straw in walls and roofs.



Higher priority

Warm rooms and thermal buffer zones

Warm rooms are an approach to keep buildings habitable in cold climates. Plastic sheeting and fixings can be used to help create thermal buffer zones (or lobbies) where people can stop on their way into an inner heated area (the warm room).

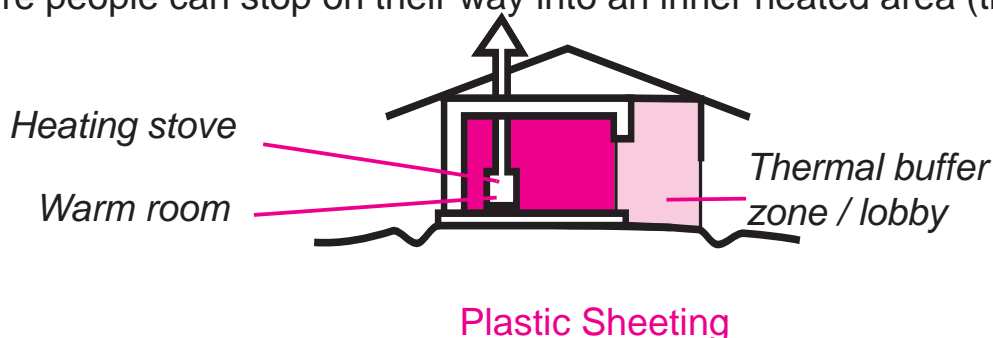

Example: Repair of damaged buildings

Plastic sheeting is commonly used to make rapid repairs to damaged buildings, to repair leaking roofs, or to reduce draughts. For family shelter it might be distributed as kits (section A.4.1) so that people can make their own repairs. Translucent plastic sheeting (section B.2.4) can be used to make temporary windows. In some cases it might be distributed with window frames.

Example: Upgrade of tents: Although good quality tents should be provided from the start, plastic sheeting is commonly used to prevent water leaking in and to prevent draughts. A basic upgrade of a tent can be made using the materials below. The plastic is attached to the rope with the rock and stone method (A.5.1).

End walls

Plastic sheet
(cut in half)

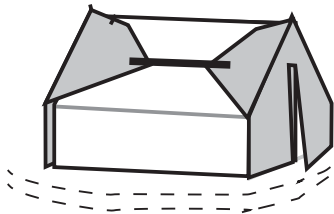
**Roof**

Plastic sheet and
Rope (20m)

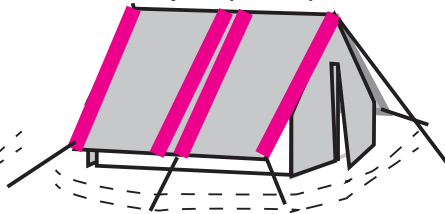
**Floor**

Ground sheet

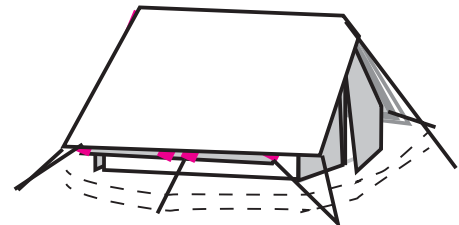

(Putting the plastic under the fly sheet will reduce the draughts and flapping of the plastic in the wind. However, people may prefer to put the plastic sheeting on top of the tent to protect the canvas and help snow to slide off.)

Condensation

Shelters made from plastic sheeting must be sufficiently ventilated even in cold climates. If they are not, vapour from breathing, cooking and sweating, will condense and can lead to damp living conditions and mould growth.

A.6.2 Hot climates

The key challenges in hot climates are to provide protection from sun, heat and rainwater. Plastic sheeting can make spaces very hot. Buildings using plastic sheeting should always be well ventilated. Use ventilated air gaps to reduce heat gain and improve heat loss. Standard plastic sheeting (B.2.3) is designed with a black core that helps to prevent structures from behaving like greenhouses.

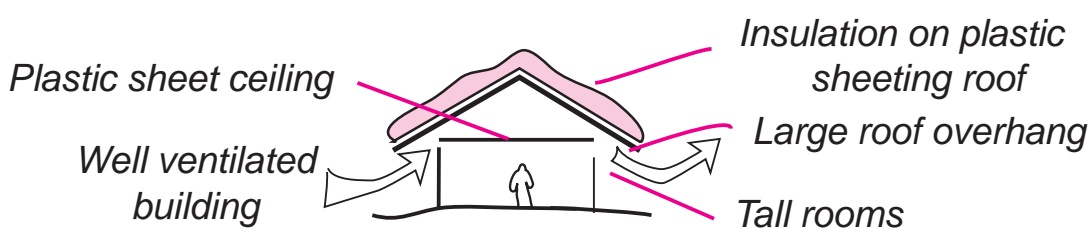

Some features of a building designed for hot climates.

A.7 Fire safety

Unless specified to contain fire retardant, plastic sheeting is flammable and produces toxic fumes when burned. Fires spread quickly and can destroy emergency structures in less than 60 seconds. Fires can be a serious cause of injury or even cause fatalities. To keep control, **Prevent fire, prepare for fire** and know what to do **in case of fire**. Below are some simple rules to observe, although local law should take precedence.

Prevention

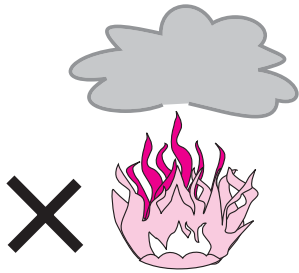

There should be **NO** open fires inside buildings

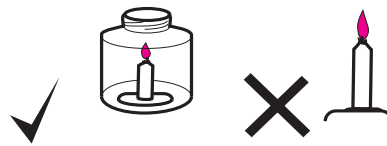

Candles **MUST** be placed within a glass jar or metal tin. Be careful with candles.

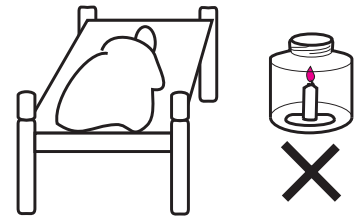

NEVER leave a candle or a fire lit while sleeping or when leaving a building



DO NOT SMOKE inside emergency structures. Dispose of cigarette butts carefully if smoking nearby.

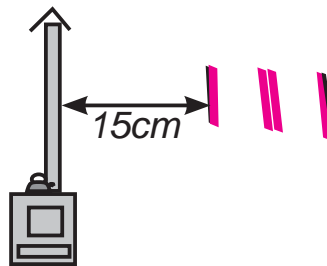

Stoves and chimneys **MUST NOT** touch plastic sheeting.

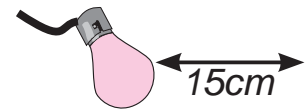

Electric light bulbs must be secured a minimum of 15cm from plastic sheeting. Wiring must be safe.

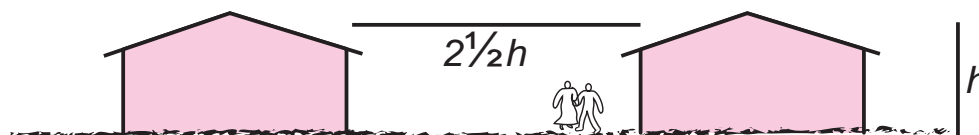

Emergency structures should be spaced $2\frac{1}{2}$ times their height apart to prevent the spread of fire. There should also be regular fire breaks.

A.8 Disposal and re-use

Recycling and re-use are the preferred means of disposal of plastic sheeting. Plastic sheeting, even when old, usually has some value to people, so the key challenges are often to ensure that it does not transmit disease and to ensure that re-distribution is to those who need it most.

If plastic sheeting must be destroyed, incineration in excess of 1200°C is the preferred option. Physical disposal has to deal with the plastic material, the reinforcing, the thread (if any) and eyelets (metal or other types of plastic).

A.8.1 Repair

Plastic sheeting is rarely welded in the field as specialised machines that operate at over 250°C are required. Minor repairs to rips and holes in plastic sheeting can be made by stitching or use of adhesive fibre tape.

Repair - stitching

Stitching plastic sheeting is the lowest cost local solution, but will lead to the plastic leaking. It must also be done with durable thread and with tightly spaced stitches to spread the load (A.5.1).

Repair - taping

While minor repairs using common adhesive fibre tape ("duct" or "gaffer" tape), this material is not UV resistant and will degrade rapidly upon exposure to sunlight and rain. Using specialized UV resistant tapes (butyl) is a better option for repairs.

A.8.2 Reuse / Recycle

Cleaning

Plastic sheeting must be cleaned prior to re-use. Surface dirt should be removed and the sheet then washed in a 0.2% chlorine solution to disinfect it. Ensure that cleaning areas are established 50m from any water sources so that run off does not contaminate streams or drinking water.

If an individual sheet cannot be repaired to make a sufficient useable size, then a patch-work sheet can be made for uses such as for sun shields, partitions, covers for barrels or vehicles. Sand bags could also be made from the sheet.

Cut into strips

If entire sheets cannot be used, then the sheets can be cut into strips or shredded. These can be used for making rope, weaving baskets, bags, screens or fencing, and are easier to handle than entire sheets.

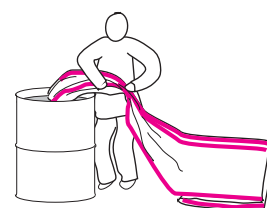

Wash in chlorine solution

Shredding

Shredding reduces the area of the sheets, which makes them easier to handle and transport. The same can be done with spare plastic bags, bottles, or containers. The shredded sheets can be used in cushions and mattresses, or it can be burnt as a fuel (see incineration below). Work is under way to see how effective plastic shreds can be in the reinforcement of mud blocks or concrete.

Recycling

Chemically processing plastic sheet to recover materials is not usually practicable and depends on the capacity of the local recycling industry.

Income generation

Work is required to clean, shred and re-use plastic sheeting. This can be tied into income generation projects.

A.8.3 Incineration (at 1200°C)

For incineration or for using plastic sheeting as fuel, the combustion must be above 1200°C. This is hotter than open fires or domestic stoves usually get, so industrial incinerators or cement kilns would be required. Care should be taken to check for potentially toxic "Products of Incomplete Combustion" (PICs). Note that the technical complexity of incineration may mean that it is not possible.

A.8.4 Burial

Burying plastic sheeting is not recommended as it may remain un-degraded in the soil for hundreds of years. (It requires sunlight to help it degrade). However, plastic sheeting is relatively inert and so is unlikely to cause contamination of the soil. If plastic sheeting must be buried, it should be buried far away from any water sources.

A.9 Other types of sheeting

A.9.1 Shade net

Shade net is an air and water permeable fabric which blocks out a fraction of the light. Various qualities are available, with different opacities (shade factor) and colours. It is normally supplied in rolls. Shade net is most commonly made from woven or knitted polypropylene or polyethylene. The opacity is affected by the colour, material, type of weave, and density.

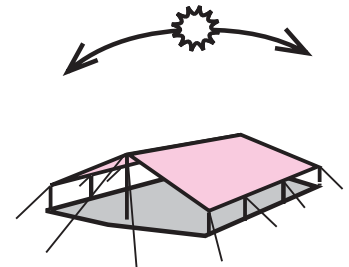

A simple structure made from shade net

Uses

Shade net is most effectively used in hot climates to shade people, structures, vehicles or supplies from heat and UV radiation. It is also used in fencing (A.4.3), for security, privacy and for crowd control.

More detail and specification on shade nets can be found in "*shade nets, use deployment and procurement of shade nets in humanitarian relief environments*" (ii.2.2)

A.9.2 Insecticide Treated Plastic Sheeting (ITPS)

What is ITPS?

Insecticide treated plastic sheeting, or ITPS, is polyethylene based sheeting impregnated during the manufacturing process with deltamethrin or other insecticides. These insecticides are released at a controlled rate over a period of up to 12-18 months. The lifetime is dependent on exposure to sunlight. Because plastic sheeting is used and adapted by beneficiaries so widely, ITPS is **not** a universal substitute for standard plastic sheeting (B.2.3) for all plastic sheeting needs, and is not widely adopted by humanitarian organisations.

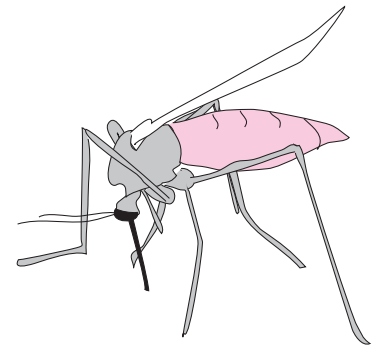

ITPS as a vector control treatment

The sheeting is intended to kill mosquitos or flies that settle on it. This is different from insecticide treated bed nets which are intended to stop people from getting bitten.

ITPS must NOT be distributed without close training and support in its use because it contains pesticide.

As with other vector control treatments such as Indoor Residual Spraying (IRS) or insecticide treated bed nets, ITPS should be used with a level of caution. The decision to use it should be made after comparison with the other mosquito and fly control options available.

Where not to use ITPS

- ITPS **must not** be used as flooring for supplementary feeding centres or clinics.
- ITPS **should not** come into contact with food as contamination can occur.
- ITPS should be avoided for parts of structures that people come into regular contact with, such as curtain doors that people have to push aside with their hands.

When to use ITPS

ITPS distribution should only take place when it can be accompanied by specific training and monitoring of its installation and use. ITPS can be used as one component of a public health campaign directed at reducing the risks of mosquito and fly borne diseases.

Where to use ITPS - Required coverage rates

ITPS is not effective in small settlements or with dispersed populations where mosquitos are less likely to rest on the sheeting. It is best used in large camp settings when high coverage rates can be achieved.

Where to use ITPS - Within shelters

ITPS is most effective if used on the walls where mosquitoes rest after biting. It is less effective in malaria control when used in roofing and should be avoided for flooring. Its effectiveness is enhanced if it can be placed in targeted locations such as sleeping areas.

ITPS should be distributed with gloves and soap. Clothing to cover arms and legs should also be available for warehouse and construction staff.

Handling

As with treated bed nets, a rash can result from touching or handling ITPS. This usually goes away within a few hours and is best treated with soap and clean water.

Consult before purchasing

ITPS itself has not yet been fully approved by the World Health Organization. Before procuring ITPS, check with government health authorities and coordinate with other humanitarian organisations working in the area. The World Health Organisation can be contacted for updates.

Introduction

Section A Planning and Use

Section B Specification

This section provides specifications for plastic sheeting and information on how some organisations buy plastic sheeting. Organisational guidelines on procurement should take precedence over the examples offered here.

B.1 Purchasing plastic sheeting	37
B.1.1 International Procurement	37
B.1.2 National / local purchase	37
B.2 Specifications	38
B.2.1 About plastic sheeting	38
B.2.2 Testing standards	39
B.2.3 Standard specification: Rolls and sheets	39
B.2.4 Translucent sheeting	42
B.2.5 Flooring	43
B.2.6 Insecticide treated plastic sheeting	43
B.2.7 Rope	44
B.3 Testing quality	45

Appendix

B.1 Purchasing plastic sheeting

Procurement guidelines and procedures of organisations should take precedence over the information provided in this section.

B.1.1 International Procurement

As most major relief organisations use framework agreements for plastic sheeting procurement, contact headquarters before procuring plastic sheeting locally. Regional and headquarters staff should identify sources of good quality sheeting in preparedness rather than at the time of a crisis.

Procurement process

Major organisations follow the procurement process illustrated below.

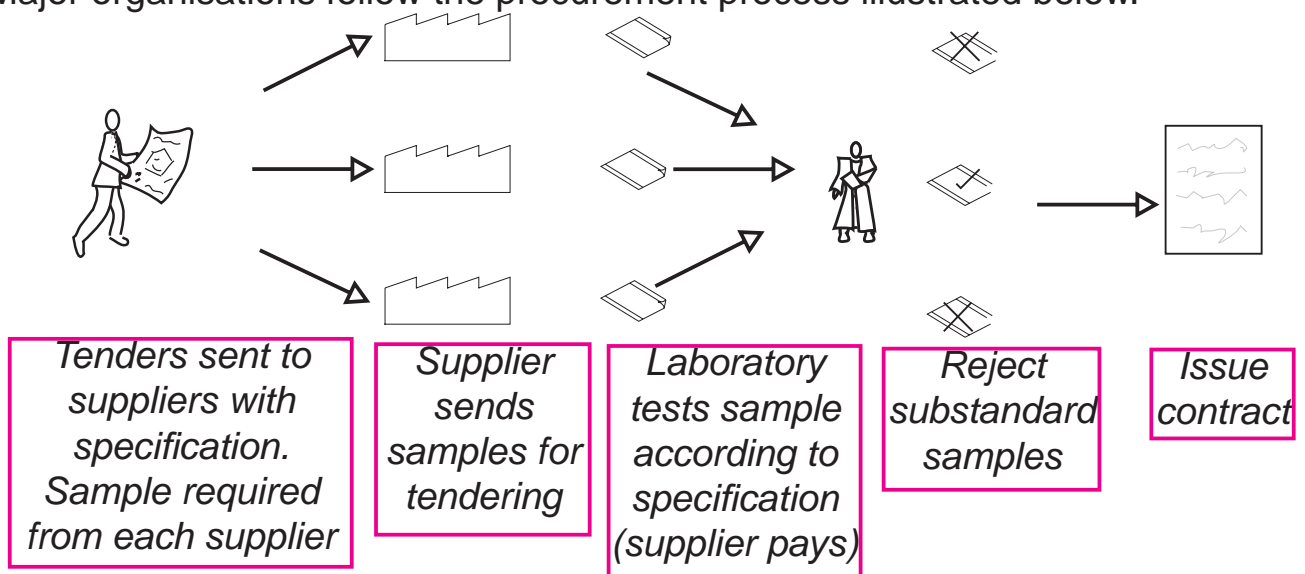

B.1.2 National / local purchase

Local purchase of plastic sheeting is preferred only if the quality can be assured. Quality is especially difficult to ensure with regards to UV resistance (which can only be tested by laboratory experiment or after long term field exposure).

Get from other organisations

Often, when many international organisations are present, it may be possible to obtain quality sheeting from another organisation. This option should be tried before local procurement is attempted.

Field tests

If there is no option other than to procure nationally, then clear specifications should be issued and the field tests in B.3.2 followed to validate the supply.

Local qualities

Some sheeting, such as translucent sheeting for windows, or small orders such as individual tarpaulins to cover a vehicle, may be best purchased locally. In these cases, conduct a market survey of the qualities that are available and the qualities that are locally used before purchasing.

B.2 Specifications

B.2.1 About plastic sheeting

Although there are many qualities of plastic sheeting available on the market, this document focuses on the standard qualities of plastic sheeting used by major humanitarian organisations. These standards should be taken as a minimum.

What is plastic sheeting made of?

The majority of the plastic sheeting procured for use in humanitarian relief is made by laminating a woven mesh of HDPE (High Density Polyethylene) between two layers of LDPE (low density polyethylene). Additional chemicals (such as Calcium Carbonate) are added to both the woven core and the exterior laminations to add colouring, to make the material flexible, to add UV stability and to alter the opacity.

Printing and reinforcement bands

These sheets are frequently printed with logos, manufacturing dates / batch numbers and marking to help with measuring. If reinforcement bands are added, they are usually welded on by the laminating machine.

Reinforcement bands are usually grey in colour to prevent confusion between plastic sheeting and any national flags.

Sheet size

Sheets are commonly produced on a standard size loom (for example 2m wide and then heat welded together to form standard 4m wide sheets.) The resulting sheet is then either cut into rolls of standard length - (commonly 50m or 60m long) or cut into individual sheets. (Commonly 4mx6m or 4mx5m). Some factories are now capable of producing 4m wide sheets without welds.

Eyelets

If eyelets are to be added, the edges are welded over a reinforcement cord and the eyelets inserted.

Packaging

After manufacture, the sheeting is finally baled and packed for transport.

B.2.2 Testing standards

Current specifications for plastic sheeting are all based on standards from the ISO (International Standards Organisation), BSI (British Standards Institute), ASTM (American Society for Testing and Materials Standards) or the International Fabrics Association (CPAI-84 for flame retardance). These organisations specify detailed laboratory testing methods that enable samples of plastic sheeting to be accurately compared with specifications.

Comparison of standards

The different standards have rough equivalents. As an example ISO 1421 contains similar tests for fabric strength to BS 2576 and ASTM D 751, although technical differences may exist between the tests.

What are the standards

The tests themselves generally require calibrated testing equipment such as a constant rate of extension tensile testing machine. As a result laboratories are required to ensure that samples meet specifications.

B.2.3 Standard specification: Rolls and sheets

Polyethylene sheet with black woven or braided core.

The specifications for "standard" plastic sheeting across the major relief organisations are all for sheets or rolls made with a **black** woven or braided **HDPE inner** with **LDPE exterior** lamination on both sides. These specifications were developed by an international peer review process led by UNHCR, and MSF 1990's. This sheeting must meet laboratory testable performance specifications. These specifications are in the tables overleaf and should be taken as a minimum.

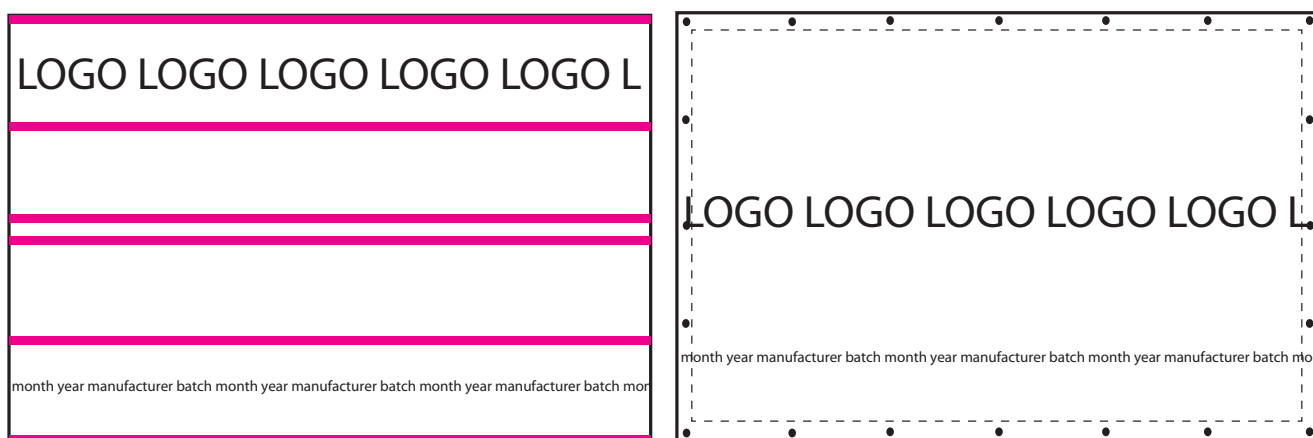

plastic sheets: left with reinforcement bands, right with seamed edges and eyelets

Minimum specification: 200g/m² Rolls and sheets	
Basic specification:	
Weight	200g/m ² ± 5% (ISO 3801). Add 10% for reinforcement. (<i>Lighter versions that meet the material performance specifications below might also be considered</i>)
Woven fabric	HDPE, BLACK colour (Black colour provides privacy and reduces heating under the sheeting due to the sun).
Lamination material	LDPE, WHITE colour on at least one side. (White colour reflects heat better in hot climates).
Either reinforcement bands (rolls and sheets) or eyelets (sheets only):	
Sealed edges (with eyelets)	One strong aluminium eyelet every 1.00m ± 5% on edges. Sealed on all sides (or 2 sides heat sealed and two sides double stitched), with nylon or HDPE ropes in hem.
Reinforcement bands	6 Grey bands of 7.5cm width made from black woven HDPE laminated on both sides.
Material specification:	
Tensile strength	Outside of reinforcement bands: Minimum 500N (ISO 1421) or Minimum 600N (BS 2576 50mm grab test) (US equivalent test ASTM D751) (For reinforced tarpaulin only: Inside of reinforcement bands: Minimum 700N (ISO1421))
Tear strength	Outside of reinforcement bands: Minimum 100N (under ISO 1421) (or BS 4303 wing tear) .
Bursting strength	Not necessarily specified. (200N/cm ² (BS 4768)).
Welding	Maximum 1 welding along the middle. Minimum 80% of the original tarpaulin strength in the weft. (This means that sheets / rolls are made from two panels).
UV resistance	Maximum 5% loss on original tarpaulin tensile strength (ISO 1421) after a minimum of 1500 hours UV under ASTM G53/94 (UVB 313 nm peak).
Temp resistance	-20 to 80°C where defined. (This is not necessary to define as HDPE/LDPE perform well within this temperature range)
Fire resistance	Ideally treated with fire retardant (CPAI 84-1995 section 6 >200°C).

Volatiles	This is not generally defined. (0.07% under ASTM D 1203) where defined.
Printing:	
Logo	On request.
Fabrication	Manufacturer name, month and year of production.
Markings	Markings every metre (to aid cutting and distribution).
Packing:	
Sheets	Packed in bales of 5 or 10, wrapped in polyethylene, sealed with a polyester band.
Rolls	Folded in the middle and wound. Wrapped in polyethylene and sealed with a polyester band.
Stacking	Criss cross stacking to avoid palette collapse.
Palettes	As per organisational standard. Example: "plastic: size 120cm x 110cm x 13cm. 3 longitudinal bottom deck lead boards. Feet are not acceptable. The packed goods must not exceed the length and width of the palette".
Shipping volumes sheets	Dependent on precise specification. Example below for 5mx4m sheets with eyelets. 3000 sheets / 20' container (without palettes) 6000 sheets / 40' container (without palettes) 2400 sheets / 20' container (with palettes) 5400 sheets / 40' container (with palettes)
Shipping volumes Rolls	Dependent on precise specification. Example below for 50mx4m rolls without reinforcement or eyelets. 256 rolls / 20' container (without palettes) 576 rolls / 40' container (without palettes) 250 rolls / 20' container (with palettes) 550 rolls / 40' container (with palettes)

B.2.4 Translucent sheeting

Translucent plastic can be used to temporarily replace window glass and improve Insulation in cold climates. (Note that anti-blast film which can be applied to windows as a security measure is not covered in this booklet)

Qualities available

Translucent plastic sheeting for use as windows should ideally be reinforced. However, reinforced types may be harder to source than plain film types which are more common locally. Woven fabrics are not sufficiently translucent for use as windows.

Specification - translucent sheeting:	
Basic specification	
Thickness	Minimum 0.150mm. 0.200mm thickness preferred
Fabric	Basic: Polyethylene film non-reinforced. Preferred: LDPE reinforced with polyester or Polypropylene or polyethylene mesh.
Rolls or sheets	Rolls are preferred to sheets, due to variable sizes of windows. Availability of rolls is usually better.
Lamination material	LDPE, translucent.
Eyelets / reinforcement	Reinforcement is preferred to eyelets.
Material specification	
UV treatment	As per 200g/m ² Rolls and sheets - see B.2.3 above.
Mechanical strength	Maximum tensile strength in both directions.
Temperature resistance	-20 to 80°C.
Printing and packing	
Printing	Printing should not reduce transparency of the sheeting.
Packing	As per standard Rolls and sheets - see B.2.3 above.

B.2.5 Flooring

At the time of writing there is no common specification for plastic sheeting for use as flooring. Standard plastic sheeting (section B.2.3) is currently used as default, although heavier weight sheets (often in excess of 600g/m²) are preferable because standard plastic sheeting has proved not to be hard wearing enough for long-term use as flooring.

B.2.6 Insecticide treated plastic sheeting

ITPS is not included in this specification section as it is awaiting WHO approval and is primarily for use in mosquito control. See section A.9.2. If approved it should have the same properties as the standard specification plastic sheeting in section B.2.3.

B.2.7 Rope

Rope is one of the most common fixings for plastic sheeting. For fixing plastic sheeting, black 5mm to 14mm diameter rope is preferred. Black rope is preferred as it resists UV degradation, although other colours (such as blue polypropylene rope) may be cheaper or more available.

Ropes can be made from various types of material, properties of some of the most common materials are summarised below.

Properties of the most common types of rope (Based on the MSF catalogue - appendix B.2)			
	Natural fibre	Polypropylene	Nylon / polyester
Strength	-	+	++
UV resistance	+++	-	+
Elasticity	+	++	++++
Wear resistance	+	+	++
Resistance to rot	-	++++	++++
Cost	Cheap	Average	Expensive

Specification - Rope: (natural fibre, nylon and polypropylene)	
Basic specification	
Weight	Large quantities are normally purchased by weight. Minimum lengths should be specified.
Dimensions	5-14mm diameter. (or 3-4mm if polyester hard braid)
Colour	Black for nylon and polypropylene, natural for natural fibres (subject to availability / cost)
Material	Polypropylene, Nylon, other polymers, or natural materials. Fibres should not be recycled (for quality).
Material specification	
Number of strands	3 or 4 strands for twisted rope. Twisted for polypropylene and natural fibres, braided for nylon.
Testing	ISO 9554
Printing and packing	
Printing	Bales of rope should be marked with type, material, manufacturer, length, tensile strength, inspection reference.

B.3 Testing quality

In the event of plastic sheeting needing to be procured nationally, or on receiving deliveries direct from suppliers, samples should be checked. Below is the procedure used by MSF to validate samples.

Validating a delivery (2 – 3 people 2 hours per sample)

Materials required for field testing

- 10m tape	- Two clamps with minimum 40mm jaws
- 100kg scale	- One hook made of 8mm steel rod
- Cutter	- One adjustable weight up to max. 10 kg (e.g. a bag filled with sand)
- Scissors	- One weight of 70kg
- 20 cm ruler	- 2x 40mm x 40mm x 1m wooden bars
- Pocket knife	- 1 punch 8mm diameter
- Permanent marker	- One hammer and some nails
- Note book and pen	
- Report forms	

A.1 Physical checking procedure:

- Write a reference number on each piece of sheeting to be tested.
- Weigh the roll or sheet of plastic without packaging. Write down the result
- Open the sheet or the roll of plastic. Check that the sheet is white or specified colour without fluctuation in colour.
- Check that there is a length indicator every meter. Check in three locations that the spacing is 1 metre.
- Check that the date, logo and markings are all in place.
- Measure the width of the plastic sheet at three locations. The width should be between 3.96 and 4.04m. Write down any comments.
- Measure the width and length of the sheet.
- Calculate the exact surface area of the sample. Divide by the sample weight in grams by the sample surface area in square metres . Check that this is within expected weights.
- Scratch the white coating of the sheet with the cutter, and check that the yarns are black in both the warp and the weft directions. Light grey is not acceptable.

A2. Physical check: For tarpaulin with reinforcement bands

- The location of the bands should not fluctuate by more than 5cm.
- Scratch the coating of the reinforcement bands with the cutter, and check that all of the yarns are black. Light grey is not acceptable.
- Peel off a band. It should leave white and black spots on the sheet and on the band (peeling the band should not entirely de-laminate the sheet).

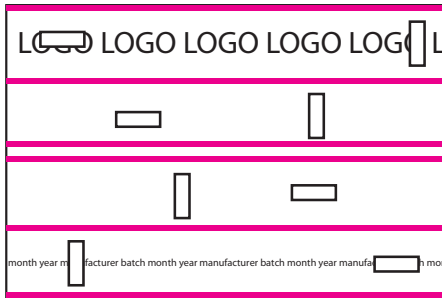

cutting 6cm x 20cm samples from a sheet for the tear test

B. Tear test

- Perform each test a minimum of 4 times on different samples. Cut 4 samples measuring 6cm x 20cm lengthways on the sheet and 4 samples crosswise into the sheet outside the reinforcement bands. Make an 8cm long cut (to start the tear) in the samples.
- Mark samples L for lengthways and C for cross ways.
- Tie the clamp to a support 2m from the floor. Clamp the plastic sheet with the first clamp.
- Clamp the second clamp to the other side of the cut in the plastic sheet and carefully release it.
- Add a weight to the bottom clamp so that the clamp and the weight total 10 Kg in weight.

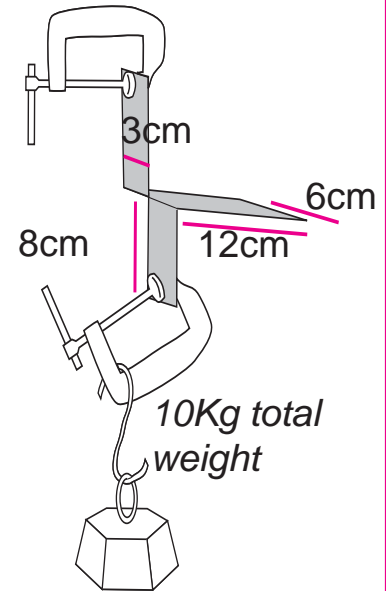

If any samples do not resist the 10 kg load then refer the sheeting to a laboratory.

C. Tear tests

- Cut three 20cm x 60cm samples in three different bands.
- Roll one end of the sample around the wooden pole and nail it using the second timber as battening.
- Support the timbers so that they lie horizontally.
- Punch a hole of 8mm diameter through the band 20 cm from the border of the sample.
- Place the hook in the hole and carefully add 70kg weight.
- Repeat tests with sample without reinforcement band and 50kg weight.

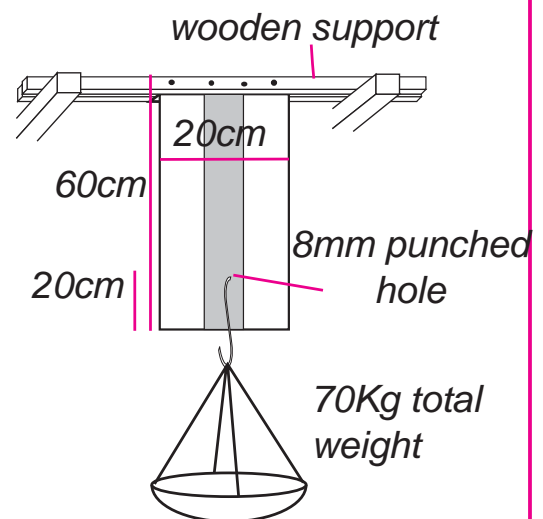

If the sample tears then refer the sheeting to a laboratory for further testing.

D. Peeling test of the coating

- Try to pull the white coating from the black fabric. It should be impossible to pull pieces bigger than 1cm².

Introduction

Section A Planning and Use

Section B Specification

ii Appendix

Glossary and annexes common to all sections.

ii.1	Glossary and acronyms.....	49
ii.2	Further reading.....	51
ii.2.1	General reference.....	51
ii.2.2	Plastic sheeting / Shade net.....	51
ii.2.3	Sanitation.....	51
ii.2.4	Shelter guidelines.....	51
ii.2.5	Infrastruture.....	51
ii.2.6	Relief item catalogues.....	52

ii.1 Glossary and acronyms

ASTM	American Society for Testing and Materials Standards.
BS	British Standard - performance standard certified by the British Standards Institute (BSi).
CPAI-84	Standard from the International Fabrics Association International for fire retardance.
Defecation field	A managed roped off area for defecation. This is as an emergency measure only and should be avoided or upgraded as soon as possible.
Geosynthetic	Synthetic material to simulate the properties of natural geological deposits such as clay.
gsm or g/m ²	The measured weight of plastic sheeting in grams per square meter of sheet.
HDPE	High Density Polyethylene. HDPE is made from un-branched chains of ethylene. (commonly grocery bags are made from HDPE).
ICRC	International Committee of the Red Cross.
IFRC	International Federation of the Red Cross and Red Crescent Societies.
IRS (Indoor residual spraying)	Spraying with insecticide with the main purpose of reducing transmission by reducing the survival of malaria vectors entering houses or sleeping units.
ISO	International Standards Organisation.
ITPS	Insecticide Treated Plastic Sheeting.
LDPE	Low Density Polyethylene. LDPE is made from branched chains of ethylene molecules. (flimsy plastic bags or plastic wrapping / cling film can be made from highly branched LDPE).
LLDPE	Linear Low density Polyethylene. LLDPE is made from un-branched chains of ethylene molecules. (Thick and glossy plastic bags are made from LLDPE).
N / Newton	Unit of force required to accelerate one kilogram one meter per second per second. One kilogram exerts a downward fore of roughly 10N at the earths surface.
Oxfam	An international humanitarian organisation.

MSF	Medecins sans Frontieres. An international humanitarian medical organisation
Nylon	A thermoplastic material. It is difficult to distinguish from polyester by appearance, although nylon burns with white smoke and polyester burn with a black smoke.
Plastic	A range of materials made by reacting more simple molecules together to make long molecular chains. Their name comes from the fact that they are malleable.
Polyester	A thermoplastic material. Polyester threads can be woven on their own or mixed with cotton to make poly-cotton.
Polyethylene / polythene	A material made from chains of ethylene molecules. See HDPE, LDPE and LLDPE.
PolyPropylene / Polypropene (PP)	A thermoplastic polymer. It is less tough than HDPE and more brittle than LDPE. It has a lower melting temperature and UV degrades faster than polyester.
Sanitation	The sector of response with the objective to provide dignity for people and to reduce the risks associated with faecal-oral diseases.
Settlement	A community of shelters.
Shade net	An air and water permeable membrane that blocks a percentage of light.
Shade factor	The percentage of sunlight blocked by the shade net.
Shelter	A covered living space providing a healthy, secure living environment with privacy and dignity for the people living within it.
Standard plastic sheeting	200g/m ² plastic sheeting with a black core. A full specification is in Section B.2.3.
Tarpaulin	A strong flexible waterproof sheet of fabric or plastic.
UV	Ultraviolet. Solar radiation with wavelengths 200-400nm wavelength. UV is the component of sunlight that is most damaging to plastic sheeting.
UNHCR	United Nations High Commissioner for Refugees.
UN/OCHA	United Nations Organisation for the Coordination of Humanitarian Affairs.
Warp	Threads that run along the length of the roll of fabric.
Weft	Threads that run across the roll of fabric.
WATSAN	Water and Sanitation.
WHO	World Health Organisation.

ii.2 Further reading

ii.2.1 General reference

The Sphere project, Humanitarian Charter and Minimum Standards in Disaster Response, 2004, (www.sphereproject.org)

Sets out what people affected by disasters have a right to expect from humanitarian assistance. Contains standards, indicators and checklists.

UNHCR Handbook for Emergencies, UNHCR, 2007 edition (www.unhcr.ch)

A managers' guide to setting up emergency operations. Provides advice on how to tackle various aspects of emergency response.

ii.2.2 Plastic sheeting / Shade net

Howard and Spice, Plastic Sheeting, Oxfam Publishing 1989

A very readable technical booklet on plastic sheeting, its procurement and its uses. Available from www.plastic-sheeting.org

Sheltercentre, MSF shade nets, use deployment and procurement of shade nets in humanitarian relief environments, MSF, 2006. (www.shelterlibrary.org)

ii.2.3 Sanitation

Lambert and Davies, Engineering in Emergencies, 2003, RedR

A technical manual on field engineering. Contains practical information for the field engineer, with strength in sanitation.

ii.2.4 Shelter guidelines

Shelterproject / Oxfam publishing, Transitional Settlement: Displaced populations, 2004. (www.shelterproject.org)

Guidelines aimed at strategic planners and implementers of settlement responses. Considers settlement options for displaced populations

UN/OCHA, tents, A guide to the logistics and use of family tents in humanitarian response, UN/OCHA, 2004 (Available from www.shelterproject.org)

ii.2.5 Infrastructure

MSF, Temporary and Semi-permanent Structures for Health Structures in Refugee camps, MSF (Available from www.shelterlibrary.org)

ii.2.6 Relief Item catalogues / specification

ICRC / IFRC (International Committee of the Red Cross / International Federation of the Red Cross) Emergency Relief Items Catalogue.

(www.icrc.org/emergency-items)

Contains specifications for plastic sheeting as well as other non food items.

MSF (Medecins Sans Frontières) Catalogue (www.msf.org/source/refbooks)

Contains specifications for plastic sheeting as well as other non food items. additionally contains field testing procedures for plastic sheeting.

UN/OCHA Timber: A guide to the planning, use, procurement and logistics of timber as a construction material in emergencies (first draft 2007).

(available from www.humanitarian timber.org)