

CLAY TILE MANUFACTURE

A Guide

John Selker

Laurie Childers

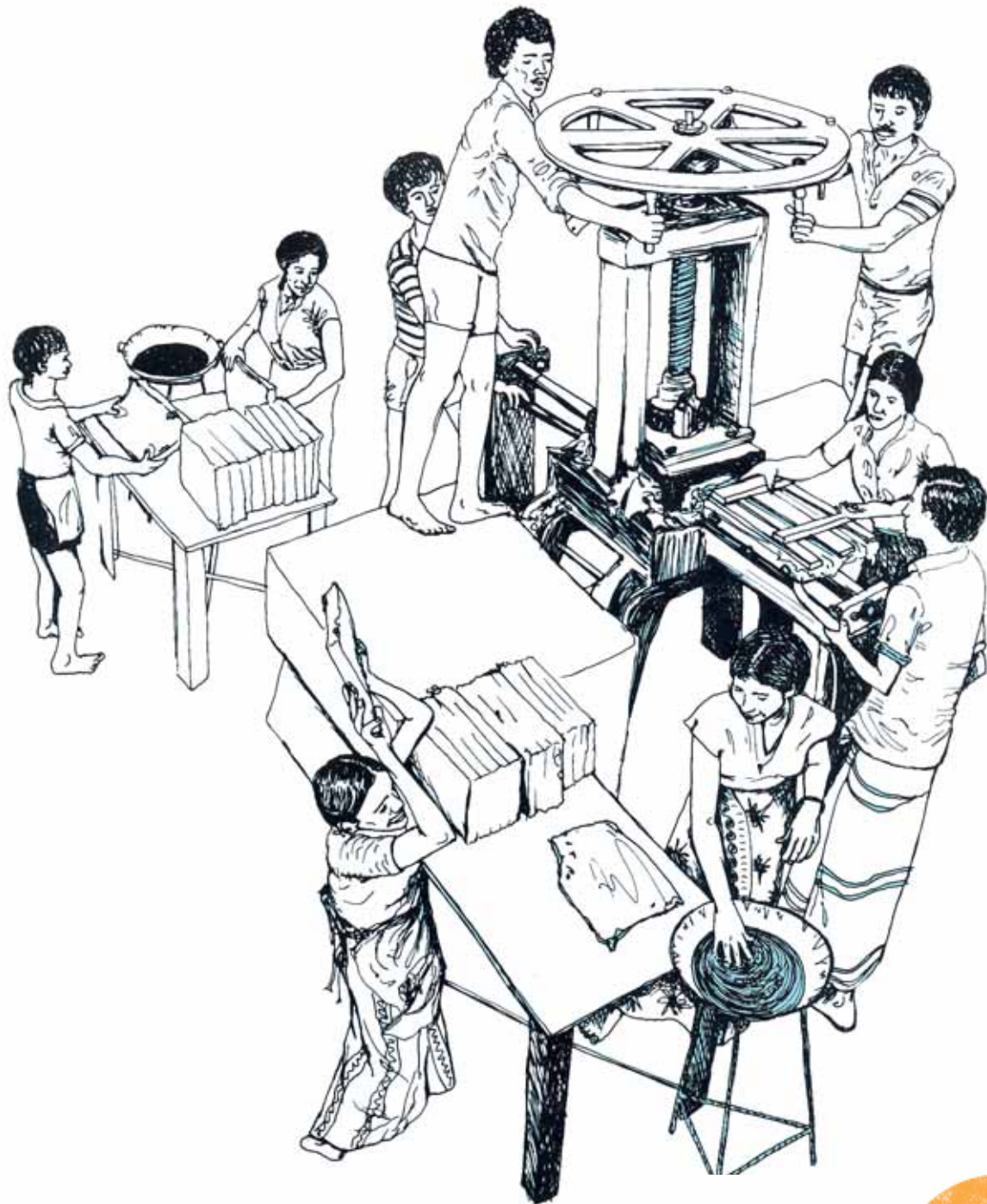

PRACTICAL ACTION
Technology challenging poverty



TABLE OF CONTENTS

Acknowledgements	3
1. Introduction	4
2. Tools	5
2.1 Pugmi 11	5
2.2 Flywheel press	5
2.3 Trimming stands	8
2.4 Tile racks and pallets	9
2.5 Kiln	10
3. Factory siting and layout	17
4. Operation of a tile production unit	19
5. Budget and finance	29
6. Bibliography and relevant institutions	30



ACKNOWLEDGEMENTS

The authors would like to thank the partners and employees of the Sumagi Tile Group, Morukkuliya, Dankotuwa, Sri Lanka for their open doors and generous sharing of information. We particularly thank Mr. Shelton Peiris, Mr. Lionel Perera, and Mr. T.Sivanadian for their substantial contributions.

This work was funded by the Building Materials Programme of the Intermediate Technology Development Group. We express appreciation to the donors for this opportunity to share a successful industry with other countries and individuals who may wish to develop their own ceramic roofing tile industries.

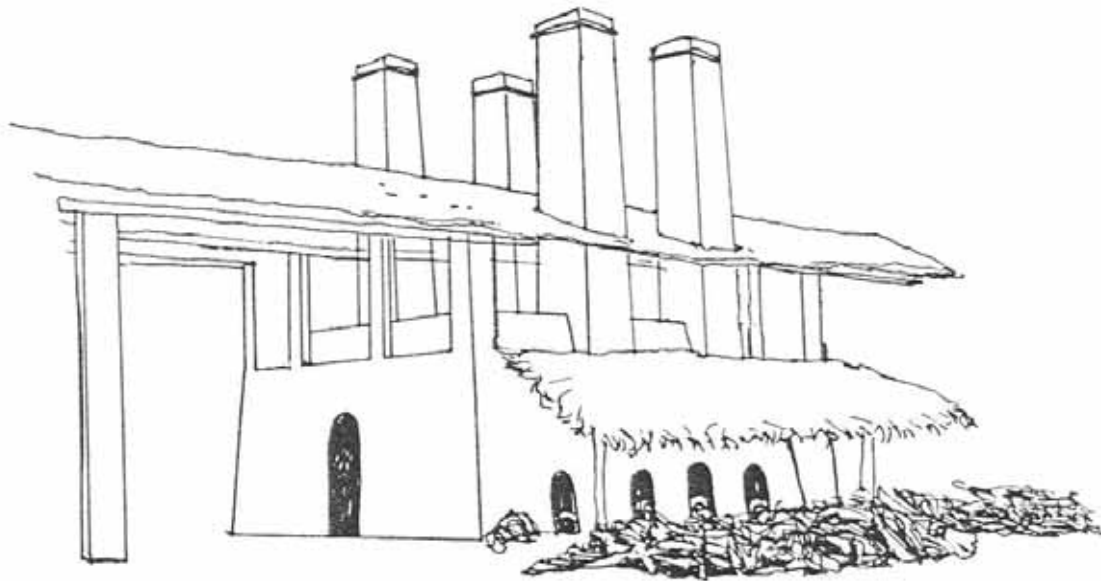

1. INTRODUCTION

This manual describes how fired clay roofing tiles are produced in Sri Lanka. Shown are the simplest tools required for medium to large scale tile production. While more sophisticated machines exist, the quality and profit possible using the production methods outlined in this guide are adequate, if not superior. These techniques have been proven for over 60 years in Sri Lanka alone.

Tile factories are built up in production units. Each unit has one pugmill, two or more tile presses, adequate clay and tile storage, and a kiln. Some large factories will include as many as six of these units on the same site, operating for the most part independently. These units use capital, land and labour to their utmost, and are easily managed by two site supervisors.

The smooth running of production starts with the proper selection of tools and careful site layout. This manual covers the essential elements from the clay supply to the correct chimney height for the kiln. Of course many additional local factors must be considered when planning to start a factory: at no point will the contents of this manual replace careful consideration and sound judgement. Proper management is most often the critical element for success.

The range of clay products which can be made on a flywheel press is very great. Dozens of roof tile designs, plus pots, floor and wall tiles, relief decoration, and other ceramic wares can be produced within the factory described here. Beyond this, some Sri Lankan factories employ potters to throw flower pots and produce other hand made items as a side line, having the clay processing and firing facilities already in operation. Decisions on tile design and product range must be made in consideration of the local needs. Minimally, a standard roof tile and a ridge tile are required for basic gable roofs. As with any other manufacturing undertaking, it is advisable to undertake a careful market survey and economic feasibility study before putting spade to earth.

Before buying land or equipment, one must assess and acquire the capital which will be needed through the first two years of operation. Working step by step through this manual, noting the tools and facilities, should give a realistic local production figure for labour, fuel and materials. This manual does not attempt to address such general business issues, keeping to those subjects which are unique to ceramic tile production.

2. TOOLS

Given access to a complete metal/machine shop and a carpentry shop, the required tools can be made in almost any country. It is advisable, however, to have each of the machined tools made from an example, so if the factory is to be in an area without examples, it may be necessary to import the first of some of these tools. Second-hand equipment can often be found in Europe for only a few hundred pounds sterling, and is completely serviceable.

2.1 PUGMILL

The Pugmill takes coarse aged clay, of correct moisture content and clay blend, and extrudes finely blended, workable clay.

The Process

Before the clay enters the pugmill all sticks, roots and debris are removed. The clay blend should be such that any 1kg lump going into the mill is quite close to the correct proportion of each clay type and the correct water content (around 22-27 per cent by weight). If the clay has hard pea-sized lumps, the pugmill will not prepare it adequately (see Raw Clay Handling, p 23). The feed clay must be well softened and broken down. Getting it into this state requires time and weathering. A simple pugmill extrudes well blended clay without major air pockets. While some minor bubbles may remain, these are eliminated in the pressing process. More expensive 'de-airing' pugmills are widely available as well, but are not required. They are more delicate in operation, much more expensive, and require more power.

A pugmill with an output of 80kg/min. is adequate to keep two presses busy for an output of up to 7,000 tiles per day. This mill will require at least 15hp to drive it, which can be provided by electric, diesel, or petrol engines. In Sri Lanka retired diesel tractors are often used and can last for more than 10 years of continuous operation. The wheels are replaced by belt drives going to turn the pugmill's gears and auger.

2.2 THE FLYWHEEL PRESS

The flywheel press is an invention of the 19th century which is still useful and appropriate. Variations of the concept come in all sizes, from three person operations to electrically driven powered presses capable of pressures up to 60 tons per square inch! The principle of the flywheel press is straightforward; a massive wheel is horizontally attached on top of a coarsely threaded shaft, which is attached to the top half of a die set. First the wheel is turned, thus raising the wheel and top die. Then the bottom die is slipped under the press with more than enough clay to produce the desired tile. The wheel is spun quickly down onto the clay. The tremendous momentum of the flywheel is converted into downward thrust by the threaded shaft, and the clay is quickly pressed into all points of the mould, with excess clay being ejected through holes in the extremes of the mould, and from between the dies.

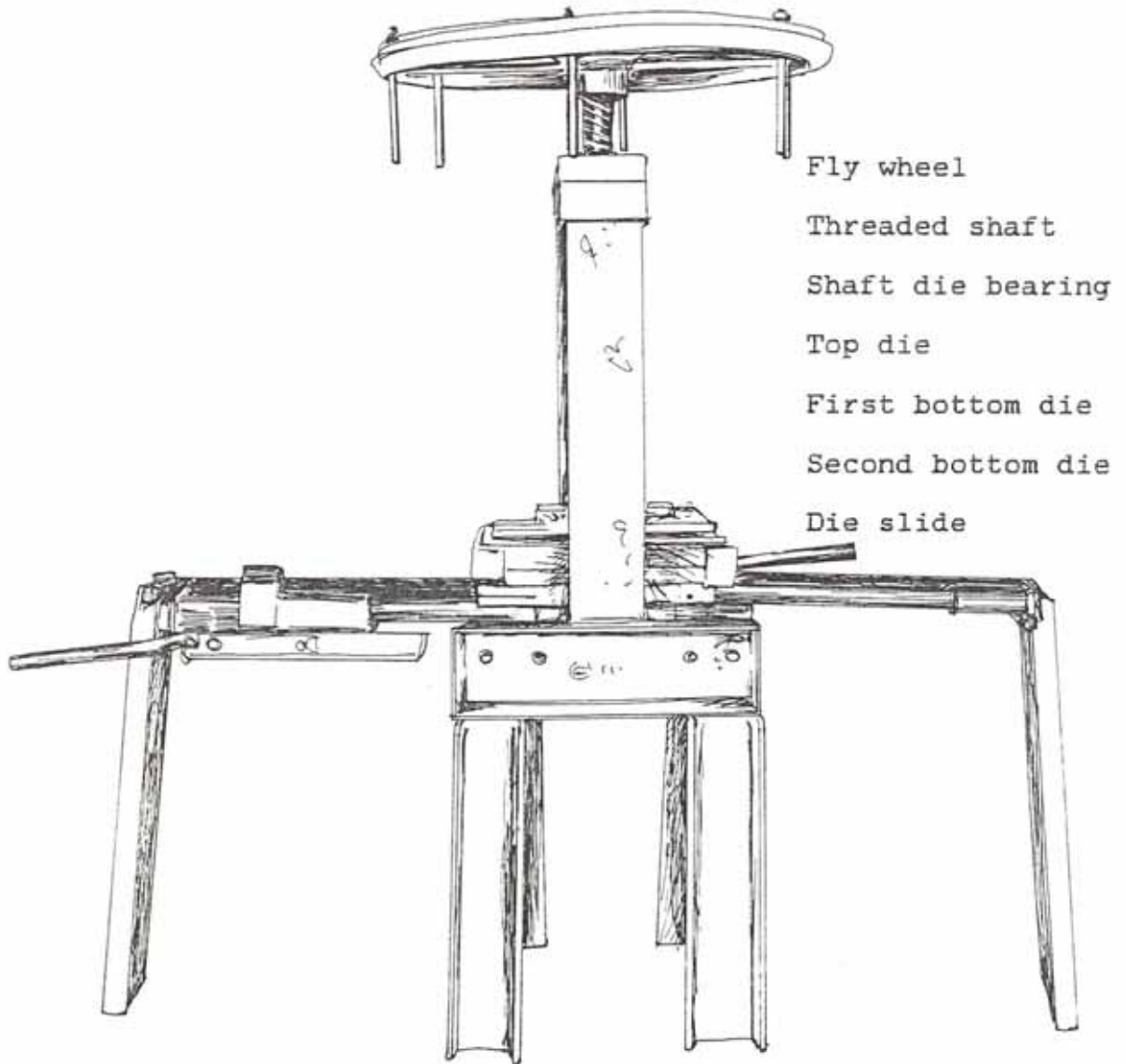

Figure 1: A 'Double Action' tile press

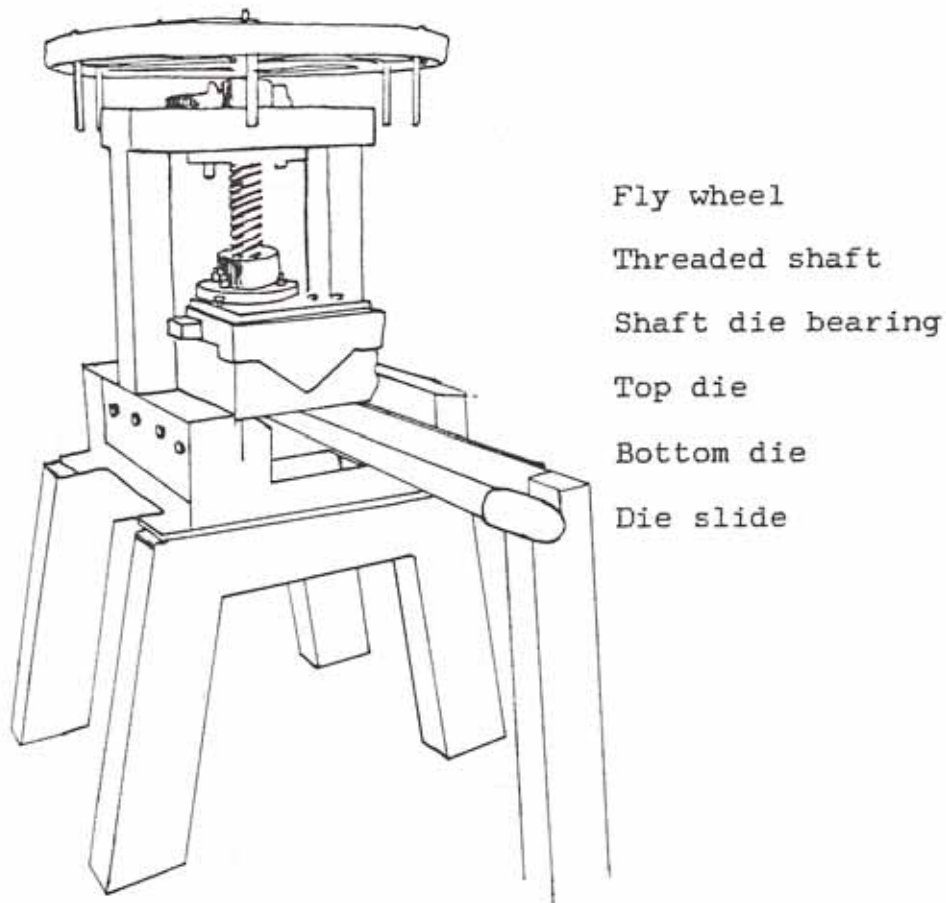

Figure 2: A 'single action' tile press.

Greatest flexibility is provided using a 'double action' (figure 1) press for high demand flat roof tiles with a 'single action' (figure 2) press for ridge tiles. By double action we mean that there are two lower dies, so while one die is being emptied of a finished tile and loaded with clay, the other die is being pressed. The double action press gives a great range of production levels as it can easily be used as a single action press if the factory needs to operate at low capacity, while its peak production rate is twice that of a single action press with very little additional cost. Its peak production (12 tiles per minute can be expected) is only eight per cent less than a modern, expensive electric revolver press!

MAINTENANCE

Although clay feels slippery to the touch, it is quite abrasive on machine parts. The flywheel press must be lubricated daily in all places where steel parts move: on the threaded shaft, the die slides, the shaft die bearing, and the lower die rails. Periodically the press should be stripped of oil, cleaned, and relubricated to remove residual grit from the slides and bearings. The dies themselves are lubricated with each slab of clay (see Operation of a tile production unit). Typically the joining of die plates themselves determines the stopping place for the flywheel. In pressing, sufficient clay is put into the press so a layer of clay is squeezed out between the dies to avoid steel on steel contact of the die plates. Even so, the die plates do wear down, and must be replaced after producing approximately one million tiles, depending on the specific clay and tile design. In active Sri Lanka factories, this means every six months.

2.3 TRIMMING STANDS

The pressed tiles must be trimmed of flashing remaining from the moulding process (see figure 3). To allow easy access to all sides of the tile a rotating stand head is used, so the trimmer can stand in one place and turn the tile with ease. This type of head can be built in many ways. Below is shown a common box head arrangement which is quite sturdy and easy to construct.



Figure 3: Trimming a tile on a rotating head stand. The stick on the stand is used for slapping the sides of the tile.

2.4 TILE RACKS AND PALLETS

After the tile is pressed and trimmed, it must be thoroughly dried before firing (see Operation of a tile production unit). Exactly how long this drying takes depends greatly on the moisture content of the clay, the particle size of the clay composition, the thickness of the tile, and the prevailing weather conditions of the area. In very hot areas a tile may dry in five days, while ten days may be required under some conditions. With an output of around 5,000 tiles per day it is clear a factory must have room for between 25,000 and 50,000 tiles in its drying racks. Drying racks and pallets are one of the more expensive elements in a tile factory, so careful planning is called for.

The racks are typically built up to 14ft high to conserve factory space, usually against outside walls for easy access and exposure to drying breezes. To stack tiles, boards are put across the aisle, resting on the stringers of the racks. Since the racks will be holding hundreds of tiles and one or more people handing tiles up, they must be sturdy. Uprights are placed on approximately 1.5m centre, and one built from 5cmx10cm lumber (see figure 27). The stringers are notched and nailed into the uprights and one made from 3cmx6cm lumber. The aisles are around 1.5m wide to allow adequate space for loading and unloading of the racks.



Figure 4: Various pallets and tiles.

Wet tiles must be placed directly from the press onto a pallet to maintain their shape (see fig. 4). Some Roman-type tiles can be placed directly on a flat surface after trimming, but all larger modern tiles must be kept on pallets until firing. The pallets must be sturdy so that they can be carried without damaging the wet tile. A well-made pallet will last over 10 years in constant use. By coating the pallet periodically with used engine oil, it can be preserved from insects. This allows the tile to slide as it shrinks during drying. Special pallets holding ridge tiles can be stacked upon each other, without racks, to about two meters high (see fig 6).

Tiles can be moved with a wheel cart: the cart holds the tiles on half inch (1cm) diameter steel rods and is easily handled by one person (see fig. 5).



Figure 5: A cart for moving wet tiles.

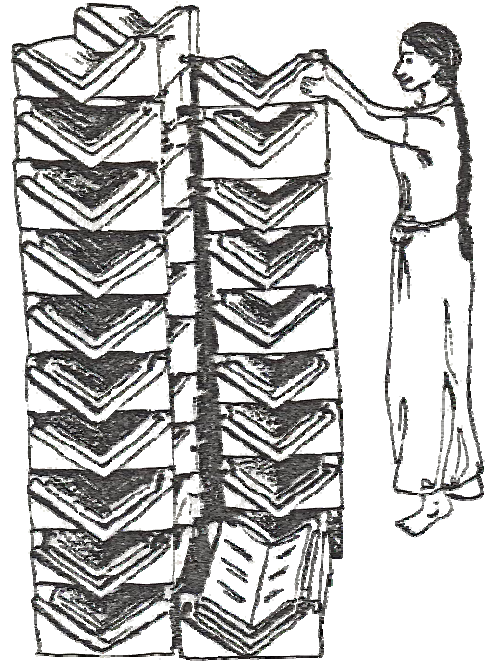

Figure 6: Stacking ridge tiles on self-supporting pallets.

2.5 KILN

The kiln fires the clay tiles into hard ceramic. Literally hundreds of kiln designs are in use today in the heavy ceramic industry. The proper kiln must match the factory's production rate, the product being produced, the fuel, and the experience level of local kiln builders and operators. The kiln design which is presented here is unusually straightforward to operate, and fits the requirements of a high output tile factory.

This kiln is of the DOWN DRAFT variety. The flames and gases from the fires enter and rise to the top of the load in the kiln. As the gases deposit their heat to the load and cool, they filter down to the bottom of the kiln, and are finally removed through the chequer floor. The chequer floor is designed to support the load while allowing gases to pass through with minimal resistance. The gases are drawn up through four tall chimneys, two on each side of the kiln. Each chimney is provided with a damper. It is important to remember that the draft is established by the suction of the chimneys, not the 'push' of the fire. To start the kiln, the dampers are left completely open. Once the draft is established, the dampers are used to regulate the draft which is kept as small as possible while maintaining adequate firing temperatures.

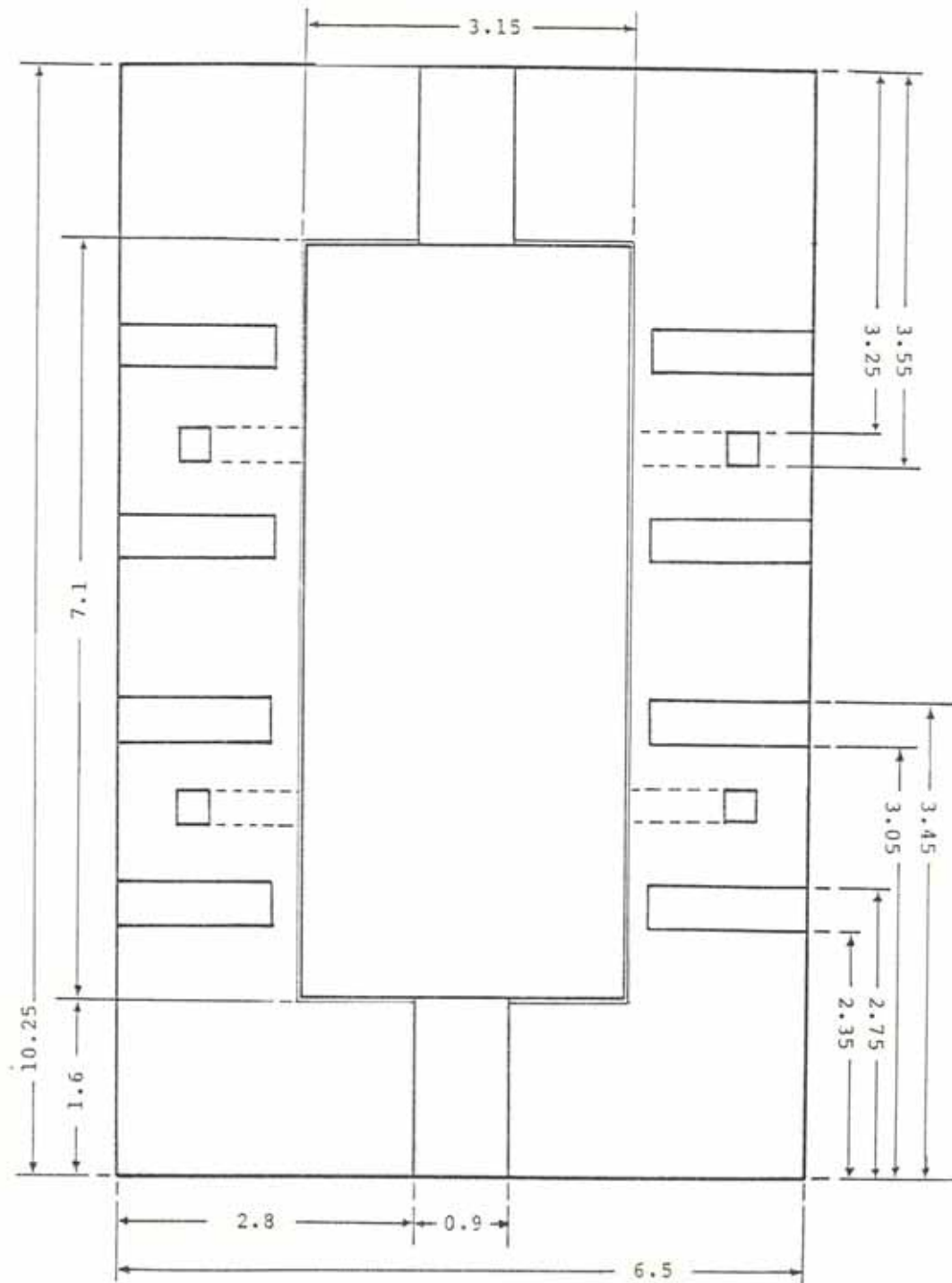

Figure 7: Floor plan of kiln at ground level.

The Kiln Construction

Construction of this kiln takes a skilled supervisor and a crew of five skilled masons and three labourers about three weeks. Four red brick types are used: a standard 5x10x20cm building brick, an arch ceiling brick tapering from 7.5 to 6.5cm over a length of 29cm, a firebox arch brick tapering from 14cm to 7cm over a length of 21cm, and a door way arch brick tapering from 10cm to 6cm over a length of 22cm. Of course the brick shapes can be altered as long as the overall kiln dimensions remain intact. This design requires no less than 300,000 bricks

to complete, which makes it somewhat expensive, but should last 20 years of continuous firing.

Except for the chimney sections above the roof, the entire kiln is assembled using a clay and sand mortar mixture. The mix is approximately 2:1 sand: clay, with enough water to make it workable. This is used exactly as cement mortar would be except that the joints are sealed. To do this a very runny mixture of mortar is poured over each layer of brick work until all internal cracks and joints are filled. A crew of three mortar mixers and carriers will keep the masons quite well supplied.

The floor of the kiln begins 70cm below the ground. The hole is dug and carefully levelled and completely compacted. Three layers of bricks are laid with clay and sand mortar mix. Throughout the construction of this kiln, bricks on the interior of walls are bonded on crossed diagonals to the walls. This technique increases the resistance of the walls to the outward force of the arch, and in the floor helps to even the weight of the load. Figures 7 through 17 show most of the details of the kiln design. The kiln shown is used at sea level. The size of the fireboxes and chimneys should be increased approximately two per cent in all linear dimensions per 1,000 feet of elevation from sea level. So at 5,000 feet you will increase the dimension 10 per cent; for instance the inside chimney dimension will go from 32cmx32cm to 35cmx35cm. Also, the height of the chimney must be increased by 6 per cent per 1,000 feet of elevation. This must be done to account for the thinner air found at high elevation.

SELECTED DETAILS

THE BAG WALL The firebox leads to a wall on the inside of the kiln called the bag wall.

This wall is attached to the body of the kiln except where the firebox meets it. There the openings flair open to let the gases out as evenly as possible, the bag wall rises to the arch roof itself (see figures 11 and 17).

THE FIREBOX (figures 9, 10, 11 and 12) The firebox is made with a 5cm ledge 35cm from its floor. This holds the grate. The grate can be made in three ways. The least expensive grate is made by simply butting two bricks together. These bricks can be used in only one or two firings, then must be replaced. A more durable grate can be made from ceramic arches made to fit the firebox. These will last for many firings. They are made in a three piece plaster mould, or in a wooden brick type mould. A final method is to use sections of railway track. Here the spacing must increase to allow ash to fall over the bottom web of the rail. The arch of the firebox is built over a wooden form.

THE ARCH CEILING The arch is built using a special tapered brick (described earlier). The key to a successful arch is a proper support during construction. Supporting formwork should be placed at least on 75cm centres and be built from 4x16cm timbers with reinforcements on both sides, where joints are made (figure 8). Stringers (or slats) from 2x8cm timber with 7cm gaps between each stringer. Each form is supported at either end on the bag walls (before it is built to its final height) and on four or five poles going to the kiln floor. This kiln uses a circular arch thus when the arch is laid the bricks line up with the centre of the arch. A second layer of standard building bricks are then layered over the arch bricks in line with the centre of the arch. It is crucial that the mortar joints be completely sealed in each layer with the runny mortar mix so no heat escapes through the arch during firing. The arch supports may be removed when the mortar is quite solid.

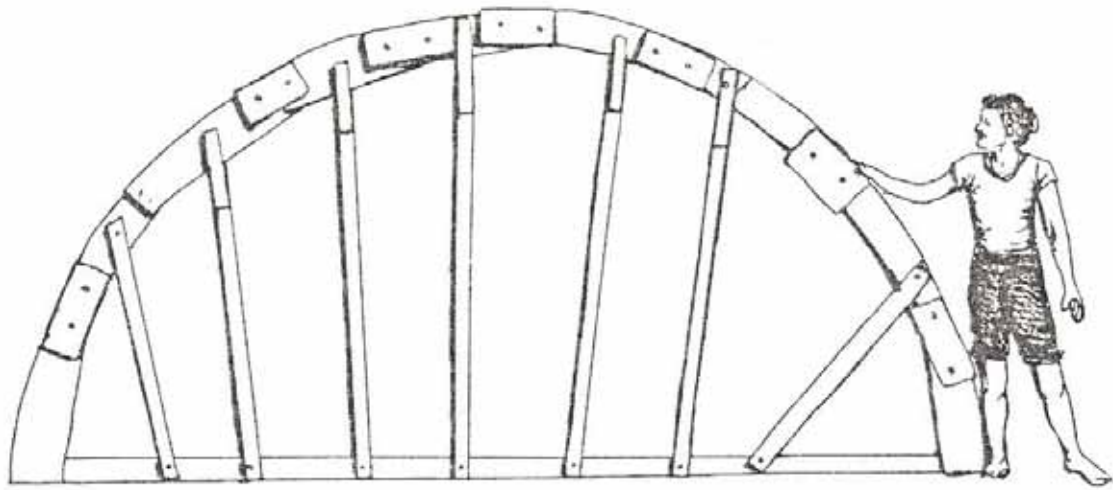

Figure 8: Form for the kiln's roof arch.

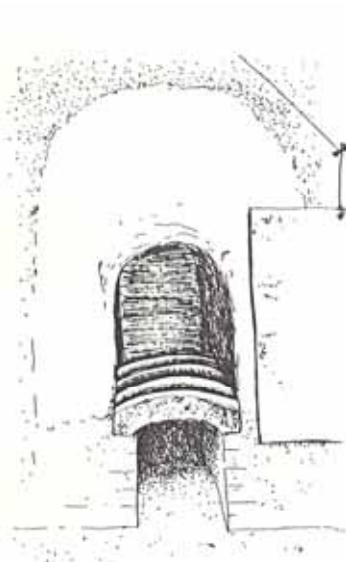

Figure 9: Kiln firebox fitted with ceramic grate arches,



Figure 10: Kiln firebox fitted with butting brick grate arches.

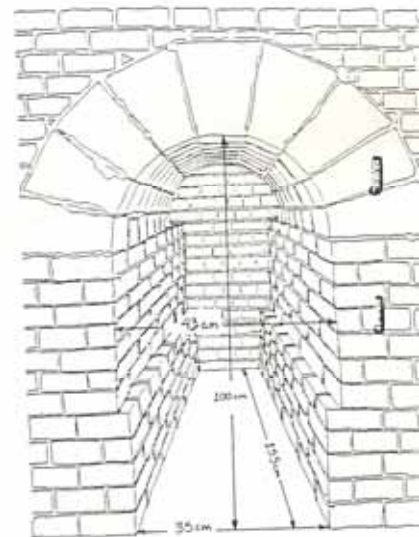

Figure 11: The internal dimensions of the kiln firebox.

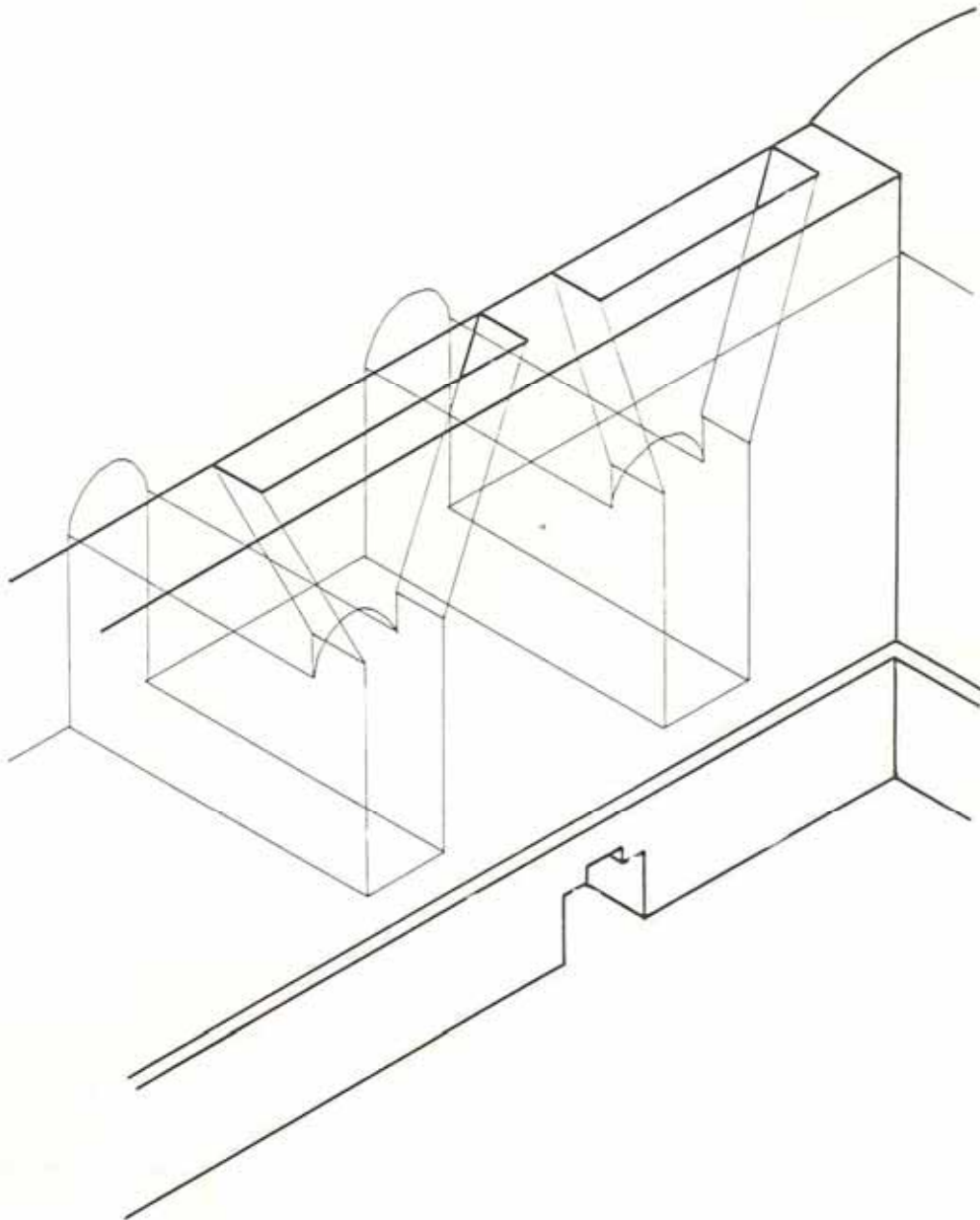

Figure 12: Illustration of the interior of the fireboxes and the bag walls from inside the kiln.

The Damper. The Dampers on the chimney ride in slots made from reinforced concrete. The damper itself must be made from very heavy gauge plate steel (over 0.8cm) to avoid warping in the high temperature flue gases. A handle should be provided on the end of the damper plate to assist in adjustments.

Above Arch Packing. Above the brick ceiling arch of the kiln you may put a packing. This is done by building a rim wall about the perimeter of the kiln, and filling over the arch. In Sri Lanka this area is generally filled with sand, but experiments with ash, or other effective insulators may lead to further fuel savings.

For details on operation of the kiln, please refer to Chapter 4.

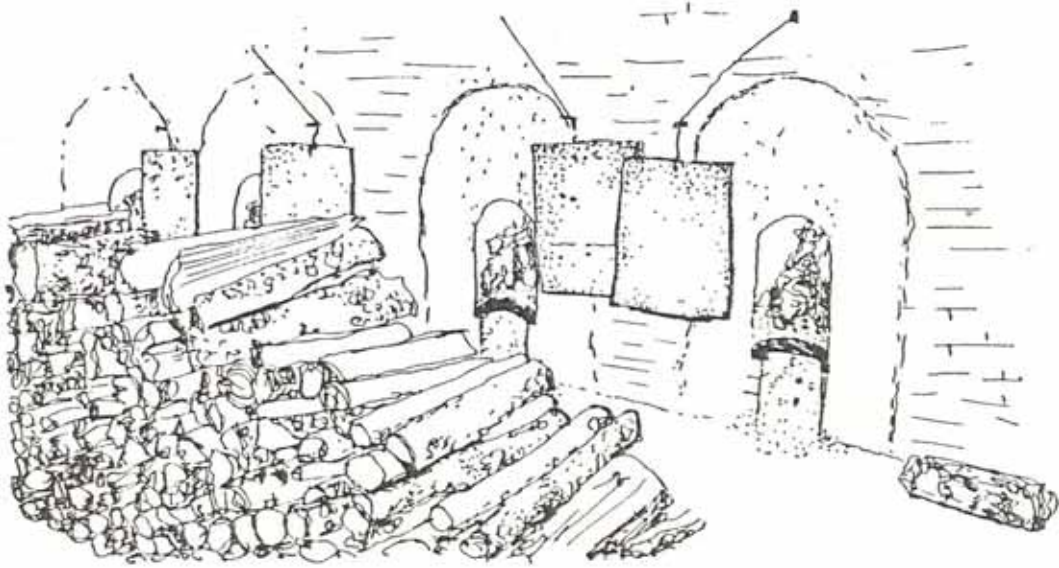

Figure 13: A row of fireboxes during firing showing hanging doors.

THE CHEOUER FLOOR In a down draft kiln the flue gases *are* removed through the floor. It is important that all parts of the kiln get equal draw, so the floor must be open enough to let the gases pass down and across in the floor to the chimney. In this kiln the floor is built on 55cm high by 30x40cm wide pillars spaced Bern apart. (see figure 14). Two layers of bricks are then layered across to make a sturdy even floor (see figure 15.)

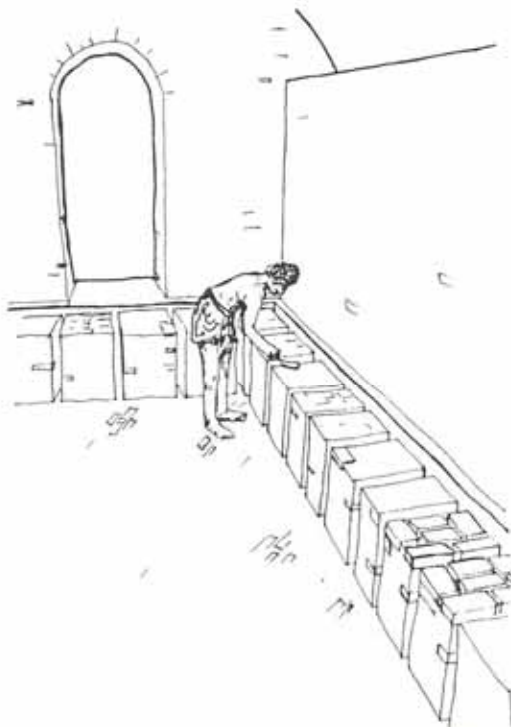

Figure 14: Putting the chequer floor support pillars in the floor of the kiln.

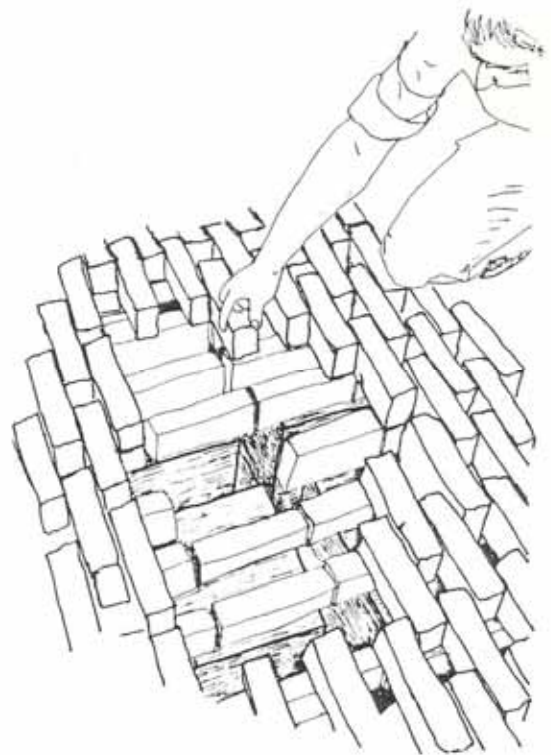

Figure 15: The layers of spaced bricks on pillars to build up the chequer floor



Figure 16: Kiln under construction showing roof mounted vent pipes made from ceramic gutter pipe

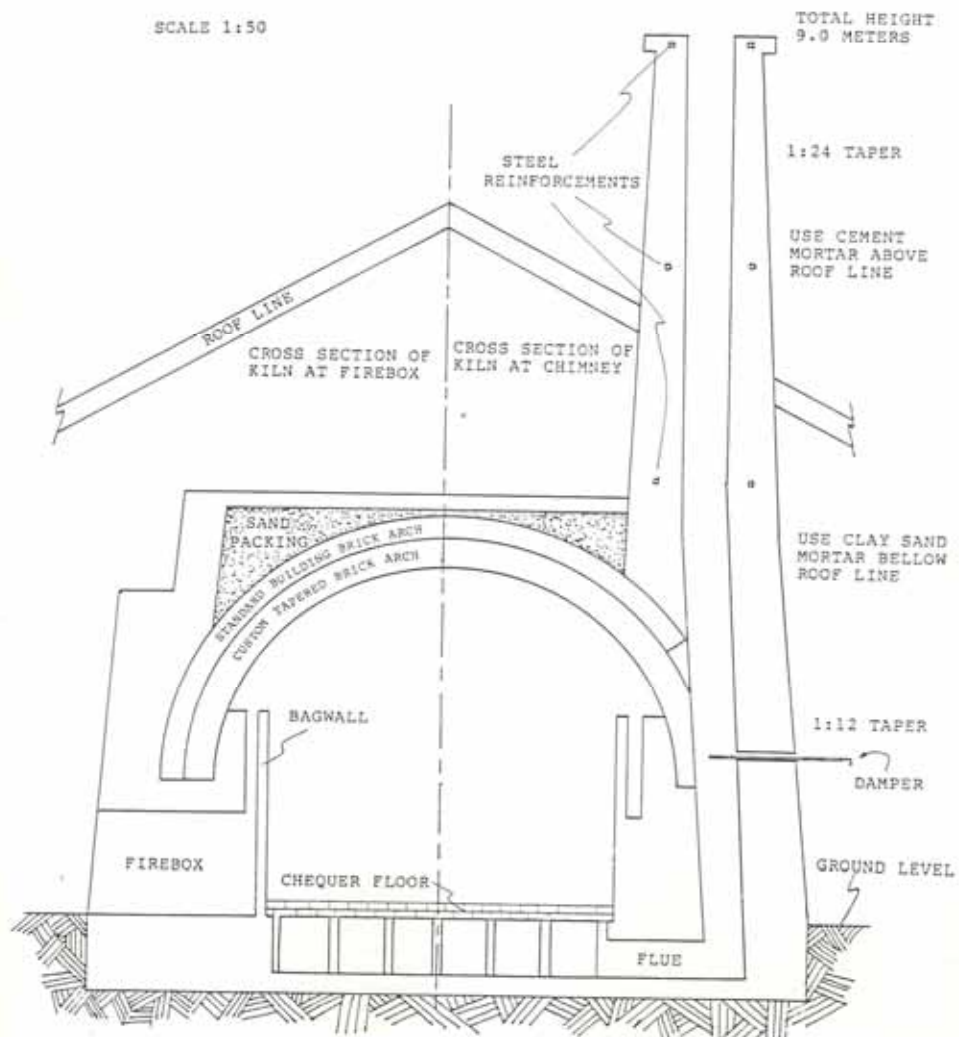

Figure 17: Cross section of down draft kiln design showing details of firebox and chimney.

3. FACTORY SITING AND LAYOUT

Having decided to invest in a tile production unit, the first decision is where the factory should be located. There are three primary requirements for factory location.

Clay Supply Clearly the factory must be in the proximity of good quality and adequate quantities of clay. Usually clay must be blended, 50 careful preliminary investigation is in order here. Generally transporting clay over four miles puts a strain on the economics of production.

Fuel Supply For each 100kg of finished tiles, 50kg of dry fuelwood is needed. A cheap and reliable supply of fuel is crucial to sustained production. It is interesting to note that some of the oldest pottery factories in Britain are located near coal mines, their fuel source, with clay being transported from fairly distant counties, because more fuel was used than clay.

Transport From the above description alone one can note that getting materials to the factory is a decisive element to success. Add to this year-round collection of several truck loads of tiles each week and obviously facilities to get heavy loads to and from the site are vital. Routes from the site to the clay mines, fuel supply, and all major local markets must be paved roads as far as possible.

Of course, the issues of good drainage, stable soil for machine and building foundations, and property lease and ownership are not to be forgotten, but are not unique to the needs of a tile factory.

To begin with, a single production unit is advised. The economics of scale in this type of tile factory are not too substantial beyond the first unit, and developing a local market and trained workers will require some time.

Factory Layout

The key to a successful layout is to keep the path of the clay/tiles as simple as possible. To layout the factory, follow the product through the complete production cycle on paper. Avoid any situations where workers must cross paths, and keep the total distance that the products travel through the factory to a minimum. Figure 17 shows a layout commonly used in Sri Lanka, with approximate floor area designated to each element. In this configuration a road is provided at each end of the factory. The same unit could be layed out to require only one access road with some increase of material movement in the factory. Notice that the entrance needs to accommodate frequent tractor loads of clay and people on foot, whereas the rear exit must accommodate standard trucks which are heavily loaded with wares (under all weather conditions).

The following dimensions are approximate requirements:

Tile drying stacks	300m ²	
Pugmill		30m ²
Press area	100m ²	
Clay prep, area	100m ²	
Kiln working area and sorting/loading	270m ²	

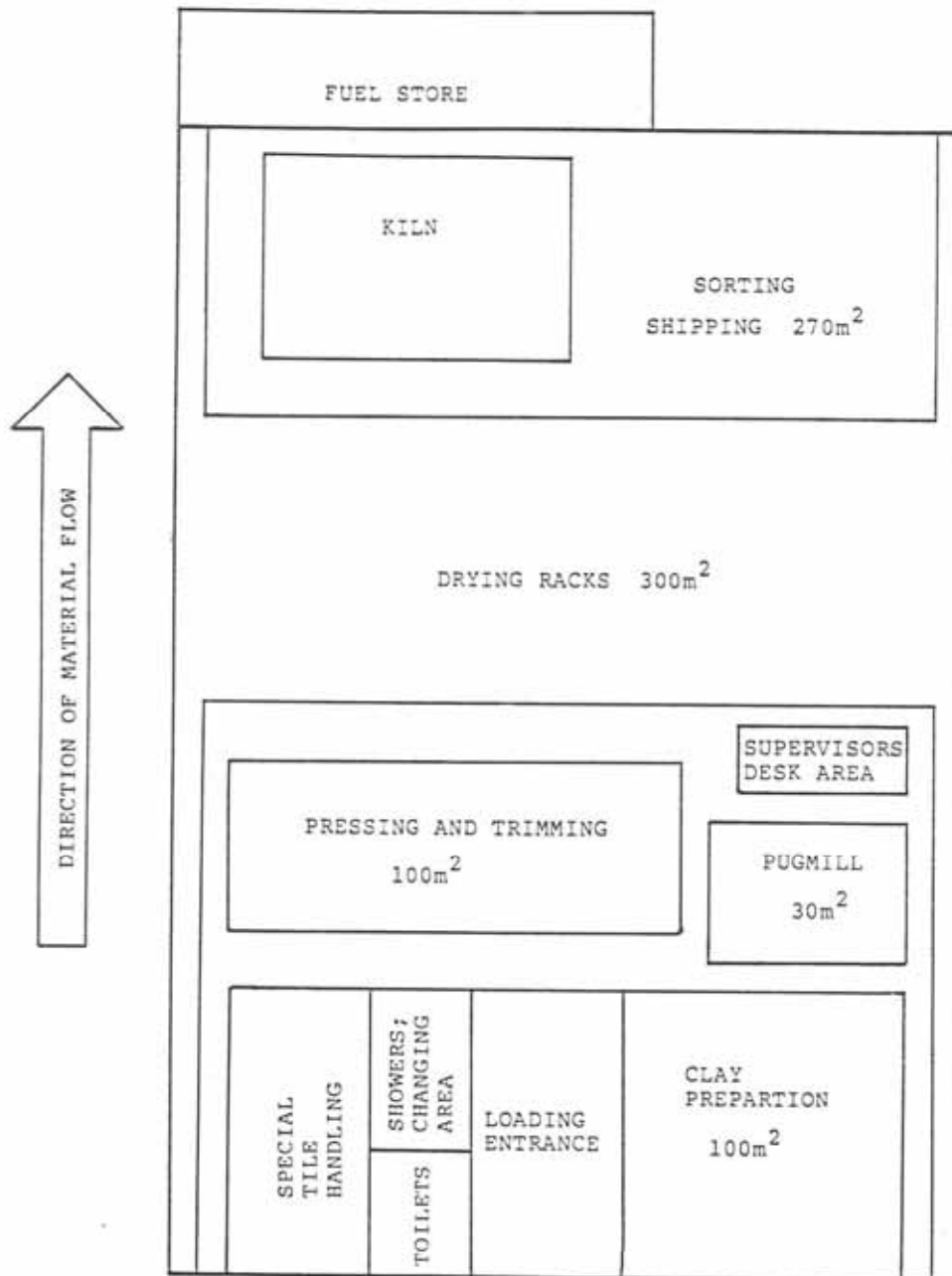

Figure 18: Typical 1,000m² production unit floor plan.

The drying racks account for a great deal of factory area, and therefore must be planned carefully. When climate is very dry, tiles may be fired after only five days, whereas in wet, cool, or humid conditions drying will take up to 10 days. Thus the total rack area needs to be adjusted according to prevalent climatic conditions. Clay type, water content, air circulation and tile design also influence the drying time. The only reliable method of determining your requirements is to run tests. In an area where there is no data on tile drying it is best to plan on a one week drying period as a starting figure, or slightly higher if the area is wet or cool.

For the production unit described in this text, a building of approximately 1,000m² is adequate for single shift six day per week production. Drying racks are put along all available exterior walls to take advantage of the increased air circulation for drying.

4. OPERATION OF A TILE PRODUCTION UNIT

An efficiently run production unit with a staff of about 50 labourers and two supervisors should be able to produce about 4,000 tiles in an eight hour shift. In summary, we can give the following average staffing requirements for a production unit:

Raw Clay Handling:

Tractor operator:	1	
Loaders:	4	(may be 1 if using a front loading tractor)
	<hr/>	
	5	

Clay Preparation:

Rough blending:	3
Pugmill loading:	4
Block cutting:	1
Block moving:	1
	<hr/>
	9

Pressing:

	Double Action Press	Single Action Press
Slab preparation:	2	1
Slab loading:	2	1
Mould handling:	2	1
Flywheel operators:	2	1
Raw Tile handling:	2	1
Trimming:	7	3
	<hr/>	<hr/>
	17	8

Stacking:

Cart handlers:	2
Rack loaders:	3
	<hr/>
	5

Kiln Operators:

Load/unloaders:	<hr/>
	10 labourers 2 days per week
	2 full time equivalents

Grading and Shipping:

Grading	2
Shipping	2
	<hr/>
	4

Site Managers:

Clay preparation and tile pressing:	1
Rack stacking and	

Kiln operation: $\frac{1}{2}$

We will now consider each step of this process to identify the significant details of their execution.

Raw Clay Handling

The quality of finished tiles rests greatly on selection and ageing of raw clay (raw clay being that which is just dug from a mine). As has been mentioned, it is likely that you will have to blend two clays (possibly more) to obtain a suitable clay for tile production. These clays may be blended at this stage or after the ageing. The clay must then age for at least one year, more typically two years. During this ageing the clay should be completely exposed to the elements (without cover). Through the natural course of wetting and drying the clots and lumps of clay break down, making the clay workable and consistent. This ageing action is absolutely necessary to obtain a high quality finished tile.

The clay storage site is easily managed by continually dumping on the top of the pile, and removing clay from the side of the pile. A front loading tractor is very helpful in this operation (blending and loading), but it can also be managed by labourers with ordinary farming hoes. A hydraulically lifting tractor trailer for labour free unloading of clay is almost essential, and certainly pays for itself in saved labour very quickly.

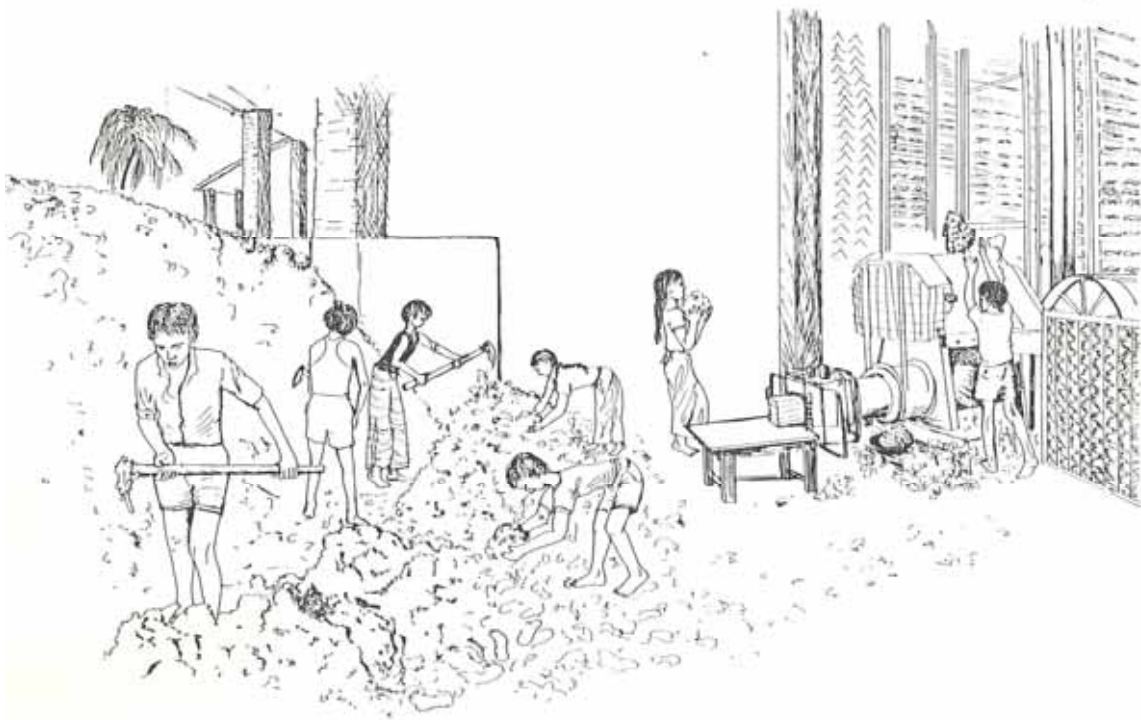

Figure 19: Clay tile processing in the factory

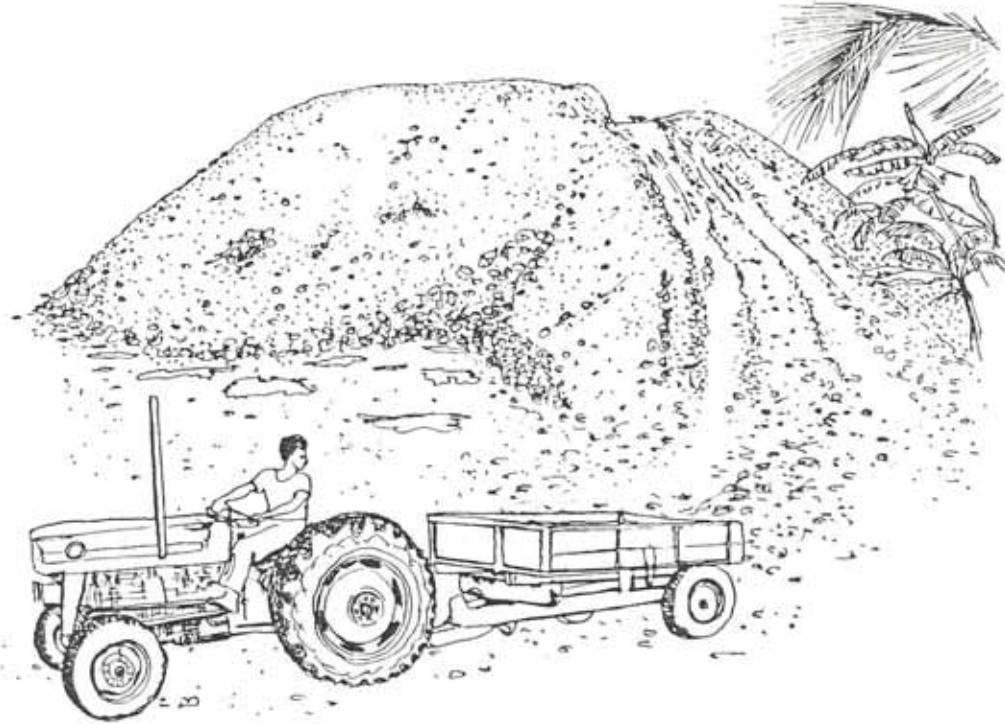

Figure 20: View of two year old clay store with tractor trailer.

The aged clay is transported from the ageing pile to the production unit each day (about four trailer loads per day). The factory should have a ramp leading to the clay store so the trailer can simply dump into the store from above.

CLAY PREPARATION

Once at the production unit the aged clay is watered to bring it up to the correct water content. The clay should be as stiff as possible while still being workable in the press, this generally works out to be between 23 and 27 per cent water by weight. The clay is then chopped using gardening hoes to provide gross blending of water and clay. The chopped clay is gathered and loaded into the pugmill. The pugmill outlet head is fitted with stretched wires which automatically slice the outgoing clay into slabs. When the required length of clay has been extruded it is sliced off using a wire mounted on a sliding frame. The blocks of sliced clay are then stacked next to the flywheel press.

PRESSING

Slabs are peeled off the pugged blocks and slapped onto an oiled steel table. This both lubricates the slab and expels air pockets from the clay. The oil is made up of 50 per cent coconut oil and 50 per cent lamp kerosene. The oil that remains on the tile also slows the drying of the tile which avoids cracking and warping.

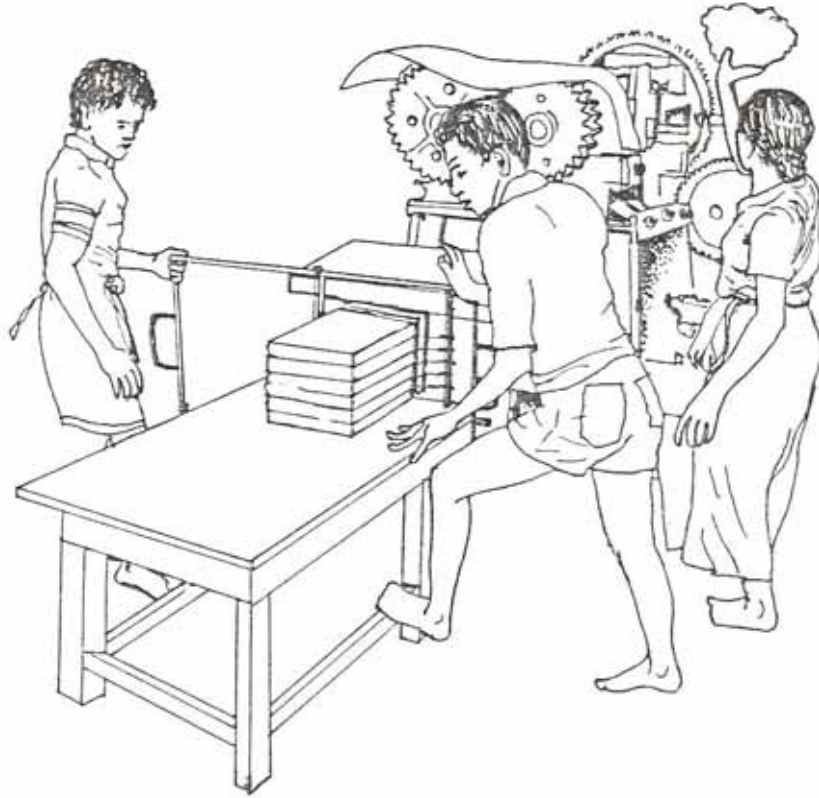

Figure 21: Cutting a block from the pugmill.

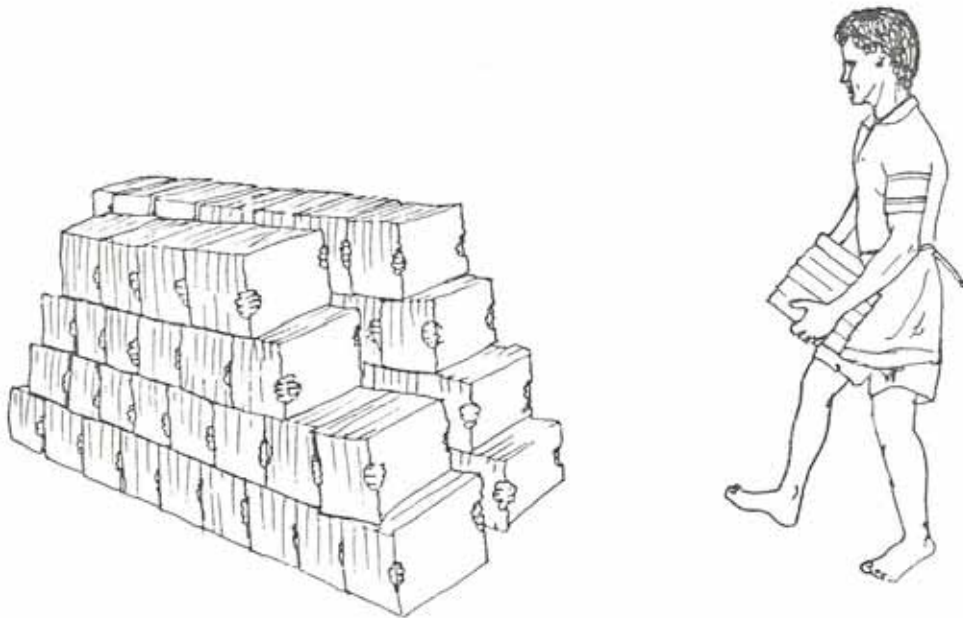

Figure 22: Carrying a block to the press area.

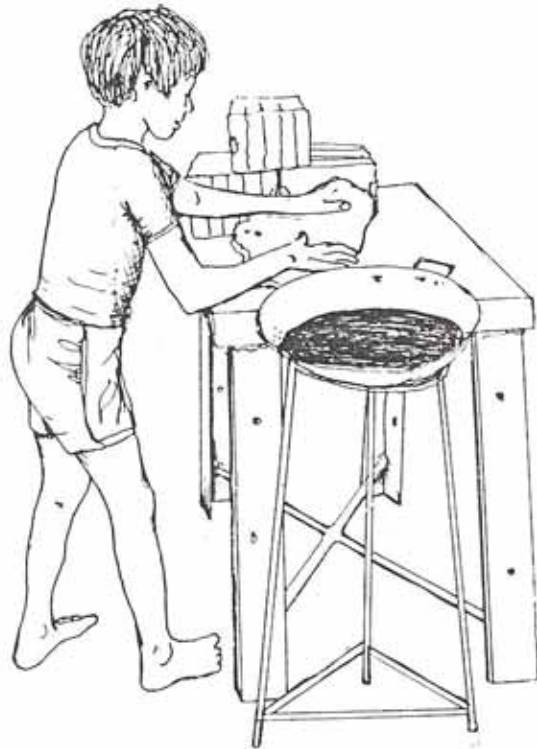

Figure 23: Slapping a slab on an oiled table.

The oiled slab is then transferred to the bottom die, which is slid under the upper die (attached to the flywheel, figure 23). The fly wheel is then spun down onto the clay. Depending on the weight of the flywheel, the strength of the spinners, and the size of the tile, it may require two impacts of the dies to press the tile adequately. The bottom die is then slid out and tilted to release the tile onto the pallet (figure 25). It should be noted that up to 15 per cent of the pressed tiles are rejected at this stage due to pressing defects. These are collected and put back through the clay preparation cycle for re-use. Figures 24 and 25 give an overview of typical production teams on both the single and double action presses.



Figure 24: Pulling the lower die from the press.

TRIMMING

The tile is now taken to the trimmers. They first remove all remaining flashing, and correct small nicks and bruises on the tile. On some tiles they will slap each side of the tile with a light slat to leave a completely smooth finish.

STACKING

The tiles are then put onto the racks to dry. Tiles may be carried by hand, or taken by cart depending on how far the racks are from the press. To get tiles to the highest racks workers will stand on boards resting on the racks on either side of the aisle, handing the tiles up. Tiles should be dry and kiln ready in between five and 10 days depending on the local conditions. If necessary the drying can be speeded up by heating the air using oil drums full of smouldering wood chips placed in the aisles. Of course, faster drying of tiles saves on drying racks and thus factory space.

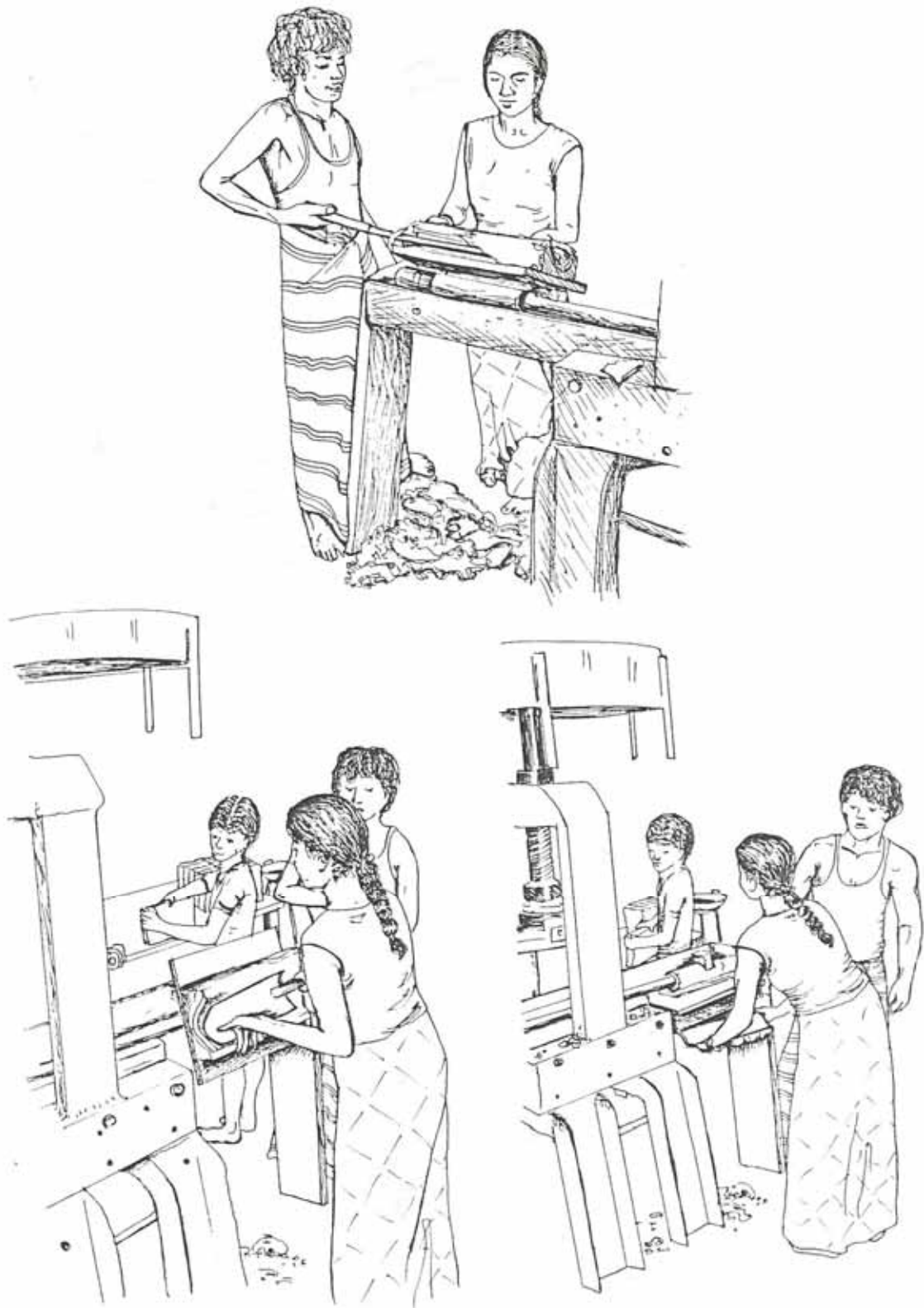

Figure 25: Removing a tile from the lower die on to a pallet

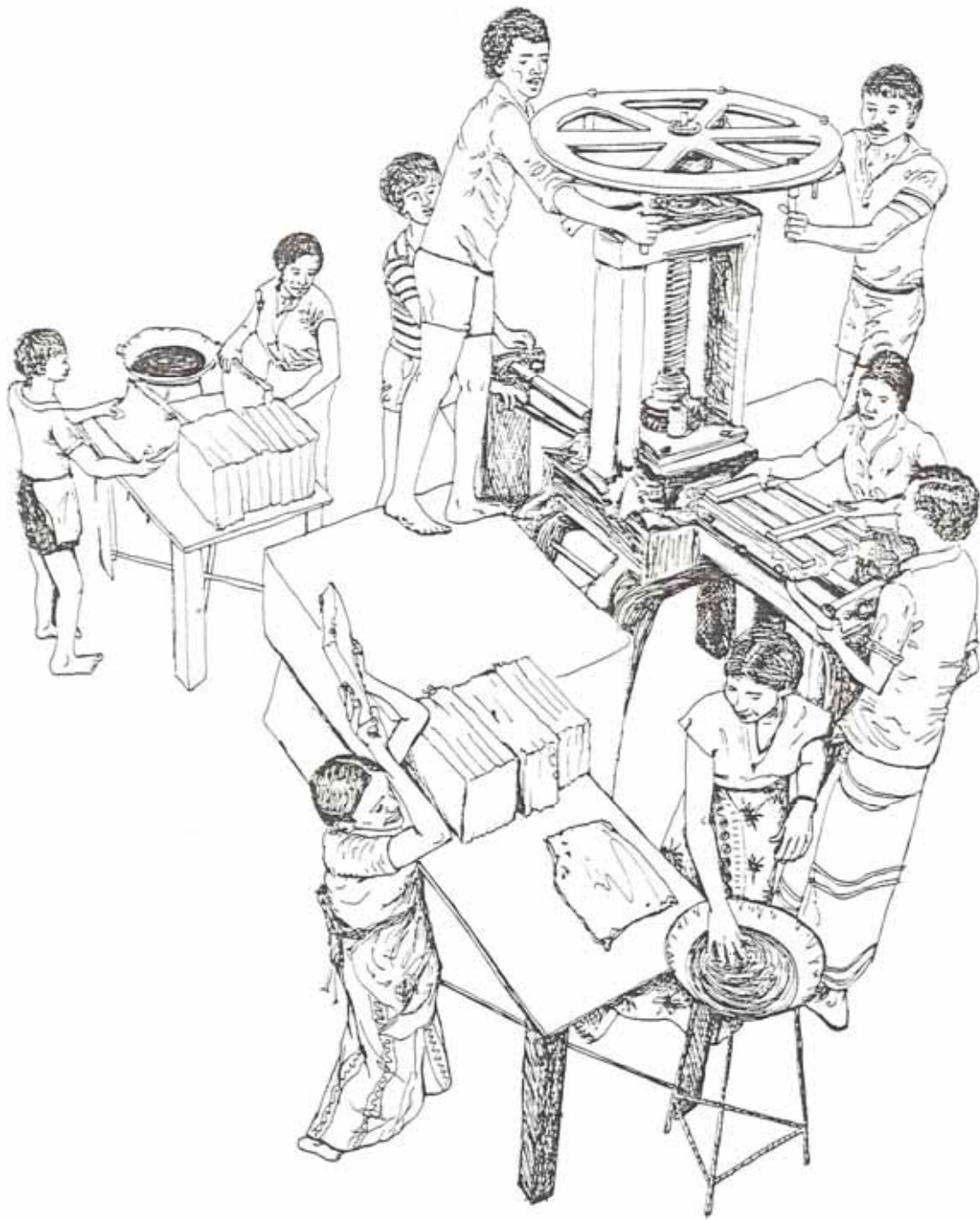

Figure 26: An overview of a double action press production site.

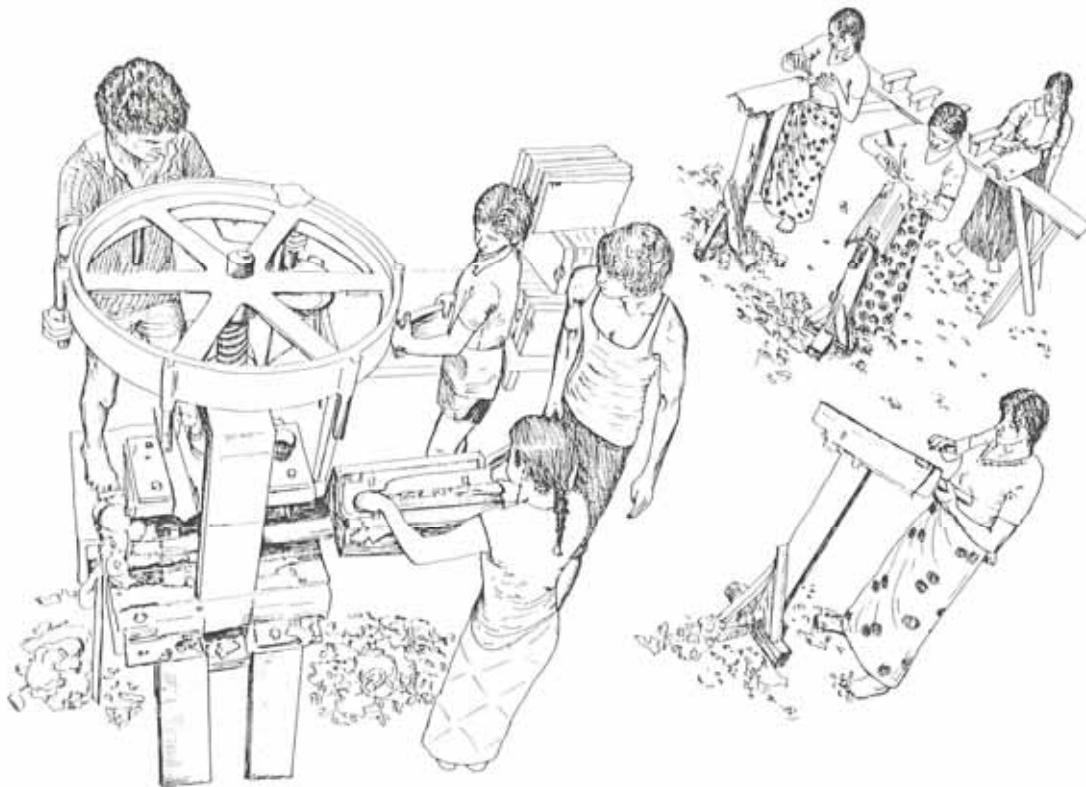

Figure 27: An overview of a single action press production site.



Figure 28: Carrying and stacking wet tiles on the racks.

KILN OPERATION

Once dry (having lost about 17 per cent of the wet weight) the tiles are removed from their pallets and stacked in the kiln. The tiles are stacked upright as close together as they will go. They are never stacked over six layers high, as any increase in weight will damage the bottom tiles in firing. If the kiln has extra space on the top of the load flower pots stoves or other light weight clay products can be fired here.



Figure 29: Carrying the tiles to the kiln.



Figure 30: Stacking the tiles in the kiln.

The kiln is fired for 48 hours, building from small fires up to full fire for the last six hours of the firing. The tiles must attain at least 850°C to become ceramic. In Sri Lanka a firing of 13,000 tiles requires 50 cubic yards of hardwood. The kiln must cool for about 36 hours before tiles can be unloaded. For the first six hours after firing the kiln is left completely sealed, then the chimney dampers are opened, and after 12 hours the ceiling vents on the kiln are opened. After about 20 hours the top 50cm of the door bricking is removed. Unloading can proceed as soon as the tiles can be handled. Generally the workers use thick gloves or pads to carry the hot tiles.

GRADING

When the kiln is unloaded each tile must be graded according to quality. In Sri Lanka, a grade 1 tile has no visible cracks or significant chips, a grade 2 tile may have small flakes missing, and cracks no longer than one inch, a grade 3 tile may have cracks under two inches long, and grade 4 tiles may be further cracked with broken corners.

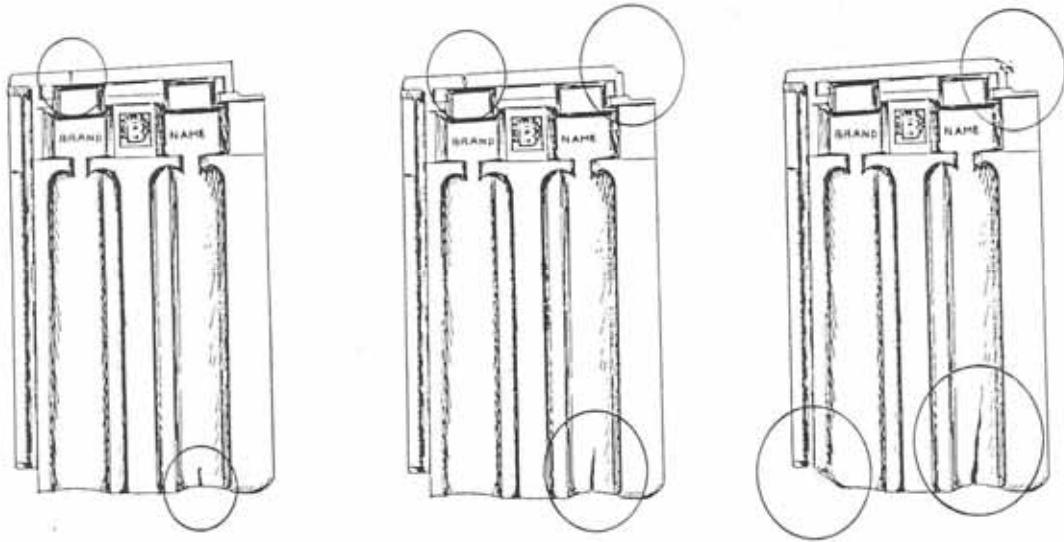

Figure 31: The various grades of tiles.

Grade	Price (US \$ per 1,000 tiles	% of Typical Load
1	125.00	87.5%
2	100.00	8.2%
3	61.00	
4	28.00	3.3%
Loss		1.0%
Average Total	\$193/1,000	100%

Table 1: Typical prices and production figures by tile quality

5. BUDGET AND FINANCE

To give the reader some idea of the financial requirements of setting up a production unit, we will review the actual cost as they are in early 1986 in Sri Lanka. It should be pointed out that the importing tariffs are fairly low in Sri Lanka, so these figures may be considered as pre-import values. Items marked with a star are locally produced. All Figures have been converted into US\$.

Building Structures	\$3,750.00
Tractor and Trailer (new)	\$8,925.00
Kiln	\$ 4 ,690 .00
Drying Racks	\$6,560.00
Drying Pallets (25,000)	\$7,140.00
Pugmill	
Engine	\$1 , 070 . 00
Pugmi 11 *	\$1 , 785. 00

Belts and 'Wheels*	\$540.00
Presses	
Double Action (with Dies)	\$1,250.00
Single Action (with dies)	\$890.00
Clay Store (2 years supply at \$7.00 per 2,000kg trailer load, and 6,000,000kg clay per year)*	<u>\$42,000.00</u>
Total	<u>\$78,600.00</u>

You will notice that over half of the expense of setting up the production unit lies in obtaining the clay stores. This is an unavoidable fact. Many factories have tried to make products from unaged clay, and the products suffer in quality hugely, and the overall reject rate goes up to at least 25 per cent.

LABOUR

Labour rates will vary greatly from area to area, but to give some idea of the labour cost we will quote the figures which apply in Sri Lanka. All figures are based on one production unit on a per day basis.

Unskilled	
Flywheel Spinners (3)	\$3.85
All Other (47)	\$47.00
Skilled	
Shop Managers (2)	\$7.90
Bookkeeper (1)	\$3.95
<u>Total labour per day</u>	<u>\$61.80</u>

6. BIBLIOGRAPHY AND ELEVANT INSTITUTIONS

Intermediate Technology Development Group - Building Materials Programme. Myson House, Railway Terrace, Rugby, CV21 3HT, U.K.

Volunteers In Technical Assistance - 1815 North Lynn Street, Arlington, Virginia, 22209, USA.

John P.M. Parry and Associates/Intermediate Technology Workshops, Overend Road, Cradley Heath, West Midlands, B64 7DD, U.K.

Brickmaking Plant: Industry Profile. United Nations Development Organization, Development and Transfer of Technology Series, 1978. United Nations Publication Sales Number E.78.II.B.9, price U.S.\$4.00 or equivalent other currencies. Write to United Nations, Sales Section, New York City, New York, USA.

Small Scale Brickmaking, Technology Series-technical Memoranda. International Labour Office, 96/98 Marsham Street, London, SW1P 4LY, U.K.